

PLUMBING

PLUMBING

MAINTENANCE

ELECTRICAL

HARDWARE

CONSTRUCTION
& BUILDING
SUPPLIES

Tools

LAWN &
GARDEN

JANITORIAL

AUTOMOTIVE

PAINT &
SUNDRIES

INDUSTRIAL

SAFETY
EQUIPMENT

New Items
In Red

BATHROOM VANITIES
DISPOSALS
DRAIN CLEANING
DRAIN REPAIR
FAUCETS
FITTINGS
FLEXIBLE COUPLINGS
SHOWER & TUB REPAIR
SINKS
TOILETS
UTILITY PUMPS
WATER HEATER REPAIR
WATER SUPPLY

PLUMBING

PLUMBING

MAINTENANCE

ELECTRICAL

HARDWARE

CONSTRUCTION & BUILDING SUPPLIES

Tools

LAWN & GARDEN

JANITORIAL

AUTOMOTIVE

PAINT & SUNDRIES

INDUSTRIAL

SAFETY EQUIPMENT

BENEKE



Fluidmaster

**General
PIPE CLEANERS**

**Genova
PRODUCTS**



Oatey

RIDGID

**WAYNE
pumps**



MILL SUPPLY CO., INC.

Phone (410) 485-3343
Fax (410) 325-2240

Toll Free 1-800-817-8183
Online: www.millsupplyco.com

TUB / SHOWER REPAIR PARTS

2.5 GPM Shower Head :

- Self cleaning head adjusts from spray to rinse
- ABS ball joint
- Chrome plated
- 2.5 GPM flow
- 1/2" F.I.P. inlet



Item # M92526
U/M - Each

2.5 GPM Shower Head :

- Self cleaning head adjusts from spray to rinse
- Brass ball joint
- Chrome plated
- 2.5 GPM flow
- 1/2" F.I.P. inlet



Item # M92527
U/M - Each

Shower Head 2.5 GPM :

- ABS construction
- Adjustable face
- 1/2" F.I.P. inlet
- Clear acrylic body sleeve
- Chrome-plated finish
- Metal ball joint



Item # M92530
U/M - Each

Massage Shower Head 2.5 GPM :

- White and grey ABS body
- Brass ball joint
- Massage or shower spray adjustment
- Smooth operation
- 1/2" F.I.P. inlet



Item # M92531
U/M - Each

Vandal Type Shower Head 2.5 GPM :

- Chrome plated
- 1" diameter nozzle
- Brass ball joint
- Smooth operation
- 1/2" F.I.P. inlet



Item # M92533
U/M - Each

Shower Head 2.0 GPM :

- Chrome plated plastic
- 2" adjustable face
- Plastic ball joint
- Economy Series
- 1/2" F.I.P. inlet



Item # M92537
U/M - Each

Shower Arms :

- Brass construction
- Chrome plated finish
- 1/2" thread on both ends



Item #	U/M	Size
M92552	Each	6"
M92554	Each	8"

Shower Arm With Flange :

- Chrome plated brass arm with 1/2" thread on both ends
- Includes chrome plated metal flange
- 8" long shower arm



Item # M92559
U/M - Each

Shower Arm Flange :

- Fits all 1/2" shower arms
- Chrome plated finish
- Steel construction



Item # M92548
U/M - Each

Shower Arm Flange With Set Screw :

- Fits all 1/2" shower arms
- ABS construction
- Chrome plated finish
- Adjustable set screw



Item # M92544
U/M - Each



MILL SUPPLY CO., INC.

Phone (410) 485-3343
Fax (410) 325-2240

Toll Free 1-800-817-8183
Online: www.millsupplyco.com

PLUMBING

MAINTENANCE

ELECTRICAL

HARDWARE

CONSTRUCTION & BUILDING SUPPLIES

Tools

LAWN & GARDEN

JANITORIAL

AUTOMOTIVE

PAINT & SUNDRIES

INDUSTRIAL

SAFETY EQUIPMENT

TUB / SHOWER REPAIR PARTS

Round Overflow Plate Assembly :

- Chrome plated
- Spring type
- Zinc die cast
- Screws included



Item # M92616
U/M - Each

Round Overflow Plates :

- Chrome plated
- Zinc die cast
- Screws not included



Item #	U/M	Description
M92611	Each	Single hole
M92613	Each	Double hole

Overflow Plate Screw :

- Standard size fits most overflows
- 1-1/2" x 1/4" - 20 thread
- Chrome plated



Item # M92619
U/M - Each

Overflow Washer :

- Sponge rubber fits most types
- Beveled from 9/16" to 3/16"



Item # M92620
U/M - Each

Tub Spout With Nose End Thread :

- 1/2" IPS thread at nose
- Chrome plated



Item # M92588
U/M - Each

Diverter Spout With Nose Thread:

- 1/2" IPS threaded at nose
- Chrome plated



Item # M92587
U/M - Each

Slide Connector Tub Spout :

- For use on 1/2" (5/8" OD) copper pipe
- Includes set screw
- Chrome plated



Item # M92592
U/M - Each

Slide On Diverter Tub Spout :

- For use on 1/2" (5/8" OD) copper pipe
- Includes set screw
- Chrome plated



Item # M92594
U/M - Each

Diverter Spout :

- Connects to 1/2" & 3/4" IPS at wall end
- Lift in back
- Includes reducing bushing
- Chrome plated



Item # M92589
U/M - Each

Diverter Spout For Personal Shower :

- Top shower adapter
- Connects to 1/2" & 3/4" IPS at wall end
- Chrome plated



Item # M92590
U/M - Each



MILL SUPPLY CO., INC.

Phone (410) 485-3343
Fax (410) 325-2240

Toll Free 1-800-817-8183
Online: www.millsupplyco.com

TUB / SHOWER REPAIR PARTS

Flip-It Tub Stopper :

- ABS & Delrin 1 pc. construction
- No tools needed for installation
- Fits most tub drains
- Flip to close or open with a simple flip of the top
- Chrome finish



Item # M92632
U/M - Each

Tip-Toe Bath Drain w/Stopper :

- Coarse thread - 1-7/8" diameter
- 11-1/2 TPI (threads per inch)
- 2-7/8" flange
- Tapped 5/16"
- Chrome plated



Item # M92656
U/M - Each

Cartridge For Tip-Toe Stopper :

- Coarse thread - 1-7/8" diameter
- 11-1/2 TPI (threads per inch)
- 2-7/8" flange
- Tapped 5/16"
- Chrome plated



Item # M92657
U/M - Each

Toe-Touch Bath Drain Assembly Kit :



- Solid brass lift & turn
- Includes 1-1/2" - 11-1/2" TPI (threads per inch) adapter bushing, 1 hole plate, screw, and adapter bar
- Fits virtually all bath wastes now in service
- Chrome finish



Item # M92629
U/M - Each

Toe-Touch Tub Stoppers :



- Activated by rubber boot
- No springs to wear out
- The original and most trouble-free toe-touch stopper in the industry
- Chrome finish



Item #	U/M	Screw Size	Height
M92631	Each	3/8"	2-3/16"
M92633	Each	5/16"	2-3/16"
M92636	Each	3/8"	1-15/16"

Twist & Turn Tub Stopper :

- Coarse thread
- 1-7/8" diameter - 11-1/2 TPI (threads per inch)
- Chrome finish
- 2-7/8" flange



Item # M92627
U/M - Each

Twist & Turn Replacement Stopper :



- Includes reversible 3/8" and 5/16" stem
- Allows theft-resistant installations
- Fits virtually all non-trip lever strainers
- Chrome plated



Item # M92626
U/M - Each

Lift & Lock Bath Waste :

- Lift-n-lock
- 20 gauge tubular brass
- 1-1/2" drain
- 2 hole overflow plate



Item # M90514
U/M - Each

Waste & Overflow Assembly :

- Adjusts to fit most bathtubs
- Chrome plated trim
- 1-1/2" drain
- Trip lever style



Item #	U/M	Description
M90513	Each	Brass
M92751	Each	PVC



MILL SUPPLY CO., INC.

Phone (410) 485-3343
Fax (410) 325-2240

Toll Free 1-800-817-8183
Online: www.millsupplyco.com

PLUMBING

MAINTENANCE

ELECTRICAL

HARDWARE

CONSTRUCTION & BUILDING SUPPLIES

Tools

LAWN & GARDEN

JANITORIAL

AUTOMOTIVE

PAINT & SUNDRIES

INDUSTRIAL

SAFETY EQUIPMENT

TUB / SHOWER REPAIR PARTS

Bath Drain Linkage

Assembly :

- Linkage assembly includes pin
- Universal fit all



Item # M92609
U/M - Each

Brass Bucket Assembly :

- Replacement for trip-lever style waste & overflow
- Includes pin
- Universal fit all



Item # M92677
U/M - Each

Tub Shoe :

- 1-1/2" tubular outlet
- Coarse thread: accepts (1-7/8" x 11-1/2) threads per inch bath strainers
- Brass



Item # M92676
U/M - Each

Tub Shoe Washer :

- Flat rubber
- 1-3/4" I.D., 2-5/8" O.D., 3/32" Thick



Item # M92675
U/M - Each

3-Prong Drain Protectors :

- Stainless Steel



Item #	U/M	Size
M91217	Each	1-5/8"
M91220	Each	1-7/8"

Shower Drain Grid :

- Snap-in type
- Fits most 4-1/2" shower stall drains
- Stainless steel



Item # M92701
U/M - Each

Shower Drain :

- Quick caulking
- Use on steel, fiberglass and plastic shower bases
- Internal compression sealing gasket
- Fits 2" schedule 40, steel or plastic pipe
- No solvent or lead required
- PVC body, stainless steel grid



Item # M92705
U/M - Each

Tub Stopper :

- Fits 1-1/2" to 2" openings
- White rubber



Item # M91213
U/M - Each

Straight Shower Rods :

- 1" diameter
- Polished aluminum
- Does not include flange



Item #	U/M	Size
M92515	Each	5'
M92516	Each	6'

Adjustable Shower Rod Flange :

- Rubber pads will not mark or deface any surface
- Just turn to tighten against wall
- Made of highly durable ABS
- Chrome plated finish



Item # M92503
U/M - Each

Round Shower Rod Flange :

- Fits 1" O.D. rod
- Chrome plated with screws
- Exposed screw type
- Sold by the pair



Item # M92502
U/M - Pair



MILL SUPPLY CO., INC.

Phone (410) 485-3343
Fax (410) 325-2240

Toll Free 1-800-817-8183
Online: www.millsupplyco.com

TUB / SHOWER REPAIR

Spraymaids : [®]

- Easy do-it-yourself installation
- Keeps water inside of bath tub and shower curtain
- Protects walls, floor, and carpets from water damage
- 48" high x 4-1/2" wide
- Sold by the pair
- Color - White



Item # M96024
U/M - Pair

Mini-Spraymaids : [®]

- Easy do-it-yourself installation
- Keeps water inside bath tub and shower curtain
- Protects walls, floor, and carpets from water damage
- 7" high x 7" wide
- Sold by the pair
- Color - White



Item # M96012
U/M - Pair

Tempo Bathtub Wall Surround :



- Five-piece bathtub wall surround
- Four ridged shelves double as self-draining soap dishes
- Attractive, textured finish
- Panels are easy to trim for window openings
- Fits alcoves 49"-60" wide x 28"-31" deep
- Value priced
- Color - White



Item # M97609
U/M - Each

4 Shelf Bathtub Wall Surround :



- Five-piece bathtub wall surround with four shelves double as self-draining soap dishes
- High-gloss finish
- Panels are easy to trim for window openings
- Fits alcoves up to 60" wide x 32" deep
- Color - White



Item # M97613
U/M - Each

Elite Bathtub Wall Surround :



- Five-piece bathtub wall surround
- Two towel bars and six shelves provide plenty of storage
- Overlapping high-impact panels adjust without cutting
- Fits alcoves 49"-60-1/2" wide x 28"-31" deep
- High gloss finish
- Color - White



Item # M97615
U/M - Each

SturdiFit Bathtub Wall Surround :



- 2-3 times thicker than average surround.....for added strength and durability
- Heavy-gauge, 5pc design with overlapping corners for a watertight seal
- Six convenient shelves for maximum storage
- Fits alcoves up to 60"W x 32"D
- High gloss white finish



Item # M97622
U/M - Each

Sterling Ensemble Shower Receptor/Base :



- Slip resistant surface
- Easy to clean high gloss finish resists mold and mildew
- Fits a standard 36" x 36" alcove
- Plastic drain with stainless steel strainer
- Color - White



Item # M97606
U/M - Each

Sterling Ensemble Shower Walls :



- Overlapping seams for watertight protection
- Easy to clean high gloss finish resists mold and mildew
- **End wall set** (contains both sidewalls) - Size; 35-1/4"W x 72-1/2"H
- **Back wall** (contains back wall only) Size; 36"W x 72-1/2"H
- Color - White



End Wall Set - Item # M97605
U/M - Each

Back Wall - Item # M97604
U/M - Each



MILL SUPPLY CO., INC.

Phone (410) 485-3343
Fax (410) 325-2240

Toll Free 1-800-817-8183
Online: www.millsupplyco.com

PLUMBING

MAINTENANCE

ELECTRICAL

HARDWARE

CONSTRUCTION & BUILDING SUPPLIES

Tools

LAWN & GARDEN

JANITORIAL

AUTOMOTIVE

PAINT & SUNDRIES

INDUSTRIAL

SAFETY EQUIPMENT

FAUCET / SINK REPAIR

Dual Thread Aerator :

- 15/16" outside thread and 55/64" inside thread
- Fits most applications
- 2.0 GPM flow
- Plastic restrictor
- Chrome plated



Item # M91058

U/M - Each

Female Aerator :

- Chrome plated brass
- With flow restrictors
- 3/4" x 27 threads
- 2.0 GPM flow



Item # M91062

U/M - Each

Swivel Spray Aerator :

- Standard dual-thread design fits most faucets
- Swivels a full 360 degrees to cover the entire sink



Item # M91060

U/M - Each

Aerator Adaptor :

- C.P. brass with washer
- Standard dual thread
- Connects to male garden hose



Item # M91064

U/M - Each

Faucet Lock Nut :

- 1/2" IPS
- Die cast



Item # M97404

U/M - Each

Faucet Coupling Nuts :

- 7/8" ballcock thread
- 1/2" IPS hole



Item #	U/M	Type
M97412	Each	Brass
M91066	Each	Plastic

Basin Rosette :

- Used as a washer between basin and lock nut
- Flat
- Sold per each



Item # M91069

U/M - Each

Hose & Spray Set :

- Includes spray head, hose, and guide



Item #	U/M	Description
M91286	Each	Spray Head Only
M91288	Each	Complete Set



MILL SUPPLY CO., INC.

Phone (410) 485-3343
Fax (410) 325-2240

Toll Free 1-800-817-8183
Online: www.millsupplyco.com

FAUCET / SINK REPAIR

Sink Hole Covers :

- Chrome plated



Standard



Snap-In

Item #	U/M	Size / Type
M91251	Each	1-3/4" Standard cover
M91255	Each	1-1/2" Snap-In cover

Basket Strainer Assembly :

- Stainless steel duo basket strainer
- Fits 3-1/2" - 4" sink openings
- Stick post basket
- With die cast nuts

Item # M91232
U/M - Each



Junior Basket Strainer Assembly :

- Stainless steel duo basket strainer
- Fits 2-1/2" sink openings
- For use with laundry tub or bar sink applications
- With die cast nuts

Item # M91236
U/M - Each



Fit-All Basket Strainer :

- Stainless Steel
- Adjustable post
- Chrome plated



Item # M91212
U/M - Each

Sink Strainer Basket :

- Stainless steel
- Fixed post
- Chrome plated



Item # M91226
U/M - Each

Crumb Cups :

- Less post
- Chrome plated



Item #	U/M	Size / Type
M90615	Each	1" - Basin
M90616	Each	1-1/2" - Sink

Garbage Disposal Strainer :

- Keeps drain open while working at sink and stops any solid or valuable objects from falling into garbage disposal
- Fits most garbage disposals



Item # M91223
U/M - Each

Drain Protector :

- Aluminum
- 3-1/16" clip on bottom

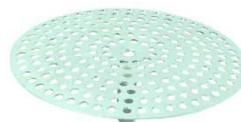

Item # M91214
U/M - Each



MILL SUPPLY CO., INC.

Phone (410) 485-3343
Fax (410) 325-2240

Toll Free 1-800-817-8183
Online: www.millsupplyco.com

PLUMBING

MAINTENANCE

ELECTRICAL

HARDWARE

CONSTRUCTION
& BUILDING
SUPPLIES

Tools

LAWN &
GARDEN

JANITORIAL

AUTOMOTIVE

PAINT &
SUNDRIES

INDUSTRIAL

SAFETY
EQUIPMENT

FAUCET / SINK REPAIR

In-Sink-Erator Stopper :

- Stopper for ISE disposal units
- Black plastic



Item # M91092
U/M - Each

In-Sink-Erator Splash Guard :

- Baffle for ISE disposal units
- Black Rubber
- 3-7/8" Diameter



Item # M97524
U/M - Each

Fits-Most Disposal Stopper :

- Black plastic
- New style 2-1/2" ID
- Sold by the each



Item # M91203
U/M - Each

Fits-Most Disposal Splash Guard :

- Fit-all replacement for most disposals
- With snap ring for holding in place
- 3-5/32" Diameter



Item # M91089
U/M - Each

Anaheim Mfg. OEM Stopper & Splash Guard :

- Direct factory replacement for Whirlaway and Sinkmaster disposals
- Perfect fit
- 3-1/8" Diameter



Item # M91091
U/M - Each

Fit-All Disposal Stopper :

- Vinyl, with knobs
- Flanged to fit all sizes
- Designed with stay-put lip to prevent slipping and can be used in basket strainers and garbage disposals



Item # M91086
U/M - Each

Fit-All Basin Stopper :

- Basin stopper fits 1" to 1-3/8"
- White rubber



Item # M91211
U/M - Each



MILL SUPPLY CO., INC.

Phone (410) 485-3343
Fax (410) 325-2240

Toll Free 1-800-817-8183
Online: www.millsupplyco.com

DISPOSALS & REPAIR PARTS

1/3 HP Garbage Disposal :

- Quick lock mounting makes installation a snap
- Designed for apartment use
- Continuous feed
- All mounting hardware included
- 1/3 horsepower
- Made in U.S.A.
- 1 year warranty



Item # M97502
U/M - Each

1/2 HP Garbage Disposal :

- Quick lock mounting makes installation a snap
- Designed for apartment use
- Continuous feed
- All mounting hardware included
- 1/2 horsepower
- Made in U.S.A.
- 1 year warranty



Item # M97503
U/M - Each

Garbage Disposal Waste Arm :

- 1-1/2" x 2-1/4" plastic
- Fits ISE and various others
- 4" Length



Item # M93694
U/M - Each

Brass Garbage Disposal Waste Arm :

- 1-1/2" x 2-1/2" x 8" brass
- Fits various types



Item # M97102
U/M - Each

Disposal Seal :

- For connecting waste arm to disposal
- Fits ISE
- Rubber
- Black



Item # M91278
U/M - Each

Garbage Disposal Clearing Wrench :

- Frees jammed disposal blades without endangering hands
- For ISE disposals



Item # M99012
U/M - Each

Garbage Disposal Clearing Wrench :

- Frees jammed disposal blades without endangering hands



Item # M99011
U/M - Each



MILL SUPPLY CO., INC.

Phone (410) 485-3343
Fax (410) 325-2240

Toll Free 1-800-817-8183
Online: www.millsupplyco.com

PLUMBING

MAINTENANCE

ELECTRICAL

HARDWARE

CONSTRUCTION & BUILDING SUPPLIES

Tools

LAWN & GARDEN

JANITORIAL

AUTOMOTIVE

PAINT & SUNDRIES

INDUSTRIAL

SAFETY EQUIPMENT

DISPOSAL REPAIR PARTS / HOSE

Disposal Dishwasher

Air Gap :

- Prevents waste from backing up
- Plastic body
- Economy



Item # M91275
U/M - Each

Disposal Dishwasher

Air Gap :

- Prevents waste from backing up
- Premium quality
- Plastic body



Item # M91274
U/M - Each

Air Gap Replacement Cap :

- Chrome plated
- Fits most air gaps



Item # M91266
U/M - Each

Dishwasher-Disposal Connector/Boot :

- Makes a quick and positive seal between drain and disposal
- Includes four clamps for easy installation



Item # M91279
U/M - Each

Diswasher Hook-Up Kit :

- Includes; stainless steel braided supply line 3/8" x 60" length
- 3/8" compression x 3/8" MIP brass elbow



Item # M99328
U/M - Each

Dishwasher Drain Hose :

- Hot water hose
- 50ft. coils
- Rubber hose



Item #	U/M	Size
M91953	Each	5/8" I.D.
M91964	Each	7/8" I.D.

Washing Machine Hose - Rubber :

- 3/8" black high-pressure hose
- 200 PSI working 800PSI burst pressure
- Female x female hose thread couplings



Item #	U/M	Size
M96510	Each	5'
M96520	Each	6'

Washing Machine Hose - Stainless Steel :

- 3/8" braided high-pressure hose
- 400 PSI working 2000PSI burst pressure
- Female x female hose thread



Item #	U/M	Size
M96553	Each	4'
M96559	Each	5'
M96562	Each	6'



MILL SUPPLY CO., INC.

Phone (410) 485-3343
Fax (410) 325-2240

Toll Free 1-800-817-8183
Online: www.millsupplyco.com

WATER SUPPLY

Flexible Supply Lines :

- 3/8" OD polyethylene tubing (PEX)
- With plastic sleeve



Lavatory



Closet

Item #	U/M	Type	Size
M99203	Each	Lavatory	3/8" x 12"
M99205	Each	Lavatory	3/8" x 20"
M99216	Each	Closet	3/8" x 12"
M99218	Each	Closet	3/8" x 20"

Flexible Sink Supply Lines :

- 3/8" compression x 1/2" IPS



Item #	U/M	Type	Size
M99303	Each	Stainless Steel	12"
M99305	Each	Stainless Steel	20"
M99253	Each	Nylon	12"
M99255	Each	Nylon	20"

Flexible Tank Supply Lines :

- 3/8" compression x 7/8" ballcock nut



Item #	U/M	Type	Size
M99317	Each	Stainless Steel	9"
M99318	Each	Stainless Steel	12"
M99273	Each	Nylon	12"
M99275	Each	Nylon	20"

Flexible Sink Supply Line f/Delta :

- 3/8" compression x 3/8" compression
- Stainless steel
- Fits Delta or any faucet with 3/8" brass risers



Item # M99258
U/M - Each

Copper Sweat Inlet x Copper Comp. Outlet :

- 1/2 Nom. Sweat x 3/8" OD compression outlet
- Angled
- For connection to wall nipple
- Chrome plated



Item # M99933
U/M - Each

Copper Comp. Inlet x Copper Comp. Outlet :

- Compression Inlet x Compression outlet
- Angled
- For connection to wall nipple
- Chrome plated



Item #	U/M	Size IxO
M99922	Each	1/2 Nom. Comp x 1/4 OD
M99924	Each	1/2 Nom. Comp x 3/8 OD

Copper Comp. Inlet x Copper Comp. Outlet :

- 1/2 Nom. compression x 3/8" OD compression outlet
- Straight
- For connection to floor nipple
- Chrome plated



Item # M99936
U/M - Each

3/8"FE x 3/8"OD Comp. "Retro" :

- Fast and easy replacement for a damaged or frozen stop
- No cutting of pipe or replacing of broken handles
- Just attach the inlet of this stop to the outlet of damaged stop
- 3/8" female inlet x 3/8" compression outlet



Item # M99939
U/M - Each

IPS Inlet x Copper Comp. Outlets :

- Angled
- For connection to wall nipple
- Chrome plated



Item #	U/M	Size IxO
M99921	Each	3/8 IPS x 3/8 OD
M99923	Each	1/2 IPS x 3/8 OD

IPS Inlet x Copper Comp. Outlets :

- Straight
- For connection to floor nipple
- Chrome plated



Item #	U/M	Size IxO
M99925	Each	3/8 IPS x 3/8 OD
M99928	Each	1/2 IPS x 3/8 OD

Dual Outlet Valves Copper Comp. Inlet x Copper Comp. Outlets :

- Rough brass
- Chrome plated



Item #	U/M	Size AxBxC
M99911	Each	1/2" x 3/8" x 1/4"
M99914	Each	1/2" x 3/8" x 3/8"



MILL SUPPLY CO., INC.

Phone (410) 485-3343
Fax (410) 325-2240

Toll Free 1-800-817-8183
Online: www.millsupplyco.com

PLUMBING

MAINTENANCE

ELECTRICAL

HARDWARE

CONSTRUCTION & BUILDING SUPPLIES

Tools

LAWN & GARDEN

JANITORIAL

AUTOMOTIVE

PAINT & SUNDRIES

INDUSTRIAL

SAFETY EQUIPMENT

WATER SUPPLY

Union Female :

- #66
- Compression x Female Pipe Thread
- Brass



Item #	U/M	O.D. Tube x FPS
M95746	Each	1/4" x 3/8"
M95747	Each	3/8" x 1/4"
M95748	Each	3/8" x 3/8"
M95756	Each	3/8" x 1/2"
M95757	Each	1/2" x 3/8"
M95758	Each	1/2" x 1/2"
M95759	Each	5/8" x 1/2"

Union Male :

- #68
- Compression x Male Pipe Thread
- Brass



Item #	U/M	O.D. Tube x MPS
M95760	Each	1/4" x 1/8"
M95761	Each	1/4" x 1/4"
M95762	Each	3/8" x 1/4"
M95763	Each	3/8" x 3/8"
M95764	Each	3/8" x 1/2"
M95765	Each	1/2" x 3/8"
M95766	Each	1/2" x 1/2"
M95780	Each	5/8" x 3/8"
M95782	Each	5/8" x 3/4"
M95783	Each	7/8" x 3/4"

Union (Tube Both Ends) :

- #62
- Compression x Compression
- Brass



Item #	U/M	O.D. Tube
M95604	Each	1/4"
M95620	Each	3/8"
M95628	Each	1/2"
M95636	Each	5/8"
M95644	Each	7/8"

Elbow Male :

- #69
- Compression x Male Pipe Thread
- Brass



Item #	U/M	O.D. Tube x MPS
M95785	Each	1/4" x 1/8"
M95786	Each	1/4" x 1/4"
M95787	Each	3/8" x 1/4"
M95788	Each	3/8" x 3/8"
M95799	Each	3/8" x 1/2"
M95804	Each	1/2" x 3/8"
M95812	Each	1/2" x 1/2"
M95828	Each	5/8" x 1/2"
M95820	Each	5/8" x 3/8"

Reducing Union (Tube Both Ends) :

- #62R
- Compression x Compression
- Brass



Item #	U/M	O.D. Tube
M95652	Each	3/8" x 1/4"
M95660	Each	1/2" x 3/8"
M95668	Each	5/8" x 3/8"
M95676	Each	5/8" x 1/2"

Elbow (Tube Both Ends) :

- #65
- Compression x Compression
- Brass



Item #	U/M	O.D. Tube
M95691	Each	1/4"
M95692	Each	3/8"
M95700	Each	1/2"
M95708	Each	5/8"

Tee (Tubing All 3 Ends) :

- #64
- Compression Three Ends
- Brass



Item #	U/M	O.D. Tube
M95683	Each	1/4"
M95684	Each	3/8"
M95686	Each	1/2"
M95687	Each	5/8"

Compression Nut :

- #61
- Brass



Item #	U/M	Size
M95564	Each	1/4"
M95580	Each	3/8"
M95588	Each	1/2"
M95592	Each	5/8"

Compression Sleeve :

- #60
- Brass



Item #	U/M	O.D. Tube
M95516	Each	1/8"
M95524	Each	1/4"
M95532	Each	3/8"
M95540	Each	1/2"
M95541	Each	5/8"

Compression Sleeve :

- 3/8" OD
- Plastic
- For use with PEX tubing



Item # M99231
U/M - Each

Chrome Plated Nipple :

- 3/8" x 6"



Item # M96922
U/M - Each

Needle Valve Kit :

- Self tapping for 3/8" to 1" tubing
- Perfect for icemakers

Ice Maker kits - Page 49



Item # M99764
U/M - Each



MILL SUPPLY CO., INC.

Phone (410) 485-3343
Fax (410) 325-2240

Toll Free 1-800-817-8183
Online: www.millsupplyco.com

TUBULAR BRASS

J-Bends :

- Chrome plated brass
- Inlet and outlet are both threaded for slip nuts
- Both connections slip joint
- 20 gauge



Item #	U/M	Size
M97021	Each	1-1/4"
M97027	Each	1-1/2"

J-Bend For Sink Trap :

- Chrome plated brass
- Slip connection inlet
- Outlet has direct flange connection
- 20 gauge



Item #	U/M	Size
M97030	Each	1-1/4"
M97033	Each	1-1/2"

P-Traps :

- Chrome plated brass
- 20 Gauge



Item #	U/M	Size
M97003	Each	1-1/4"
M97006	Each	1-1/2"

Wall Bends :

- 9" chrome plated brass
- 22 gauge



Item #	U/M	Size
M97035	Each	1-1/4"
M97036	Each	1-1/2"

Quick Repair Traps :

- Chrome plated
- 20 gauge
- Slip joint connection on both ends



Item #	U/M	Size
M97009	Each	1-1/4"
M97015	Each	1-1/2"

Straight Tailpieces :

- Chrome plated brass
- 22 gauge



Item #	U/M	Size
M97060	Each	1-1/2" x 8"
M97063	Each	1-1/2" x 12"

PO Plug :

- Chrome plated brass with rubber stopper and chain
- 1-1/4" x 5"



Item # M91298
U/M - Each

Slip Joint Extension Tubes :

- Chrome plated brass
- 22 gauge



Item #	U/M	Size
M97075	Each	1-1/4" x 8"
M97078	Each	1-1/4" x 12"
M97081	Each	1-1/2" x 8"
M97084	Each	1-1/2" x 12"

Threaded Tubes :

- Chrome plated brass
- 20 gauge



Item #	U/M	Size
M97106	Each	1-1/4" x 12"
M97108	Each	1-1/2" x 12"

PLUMBING

MAINTENANCE

ELECTRICAL

HARDWARE

CONSTRUCTION & BUILDING SUPPLIES

Tools

LAWN & GARDEN

JANITORIAL

AUTOMOTIVE

PAINT & SUNDRIES

INDUSTRIAL

SAFETY EQUIPMENT



MILL SUPPLY CO., INC.

Phone (410) 485-3343
Fax (410) 325-2240

Toll Free 1-800-817-8183
Online: www.millsupplyco.com

Page 15

PLUMBING

MAINTENANCE

ELECTRICAL

HARDWARE

CONSTRUCTION & BUILDING SUPPLIES

Tools

LAWN & GARDEN

JANITORIAL

AUTOMOTIVE

PAINT & SUNDRIES

INDUSTRIAL

SAFETY EQUIPMENT

TUBULAR BRASS

Extension Tubes :

- Chrome plated brass
- 22 gauge



Item #	U/M	Size
M97067	Each	1-1/2" x 8"
M97069	Each	1-1/2" x 12"

Slip Joint Waste Arms :

- Chrome plated brass, 1-1/2"
- 20 gauge



Item #	U/M	Size
M97120	Each	9-1/2"
M97132	Each	15"

Direct Connection Waste Arms :

- Chrome plated brass, 1-1/2"
- 20 gauge
- 15" length



Item # M97129
U/M - Each

Double Slip Extension Couplings :

- Chrome plated brass



Item #	U/M	Size
M97087	Each	1-1/4"
M97090	Each	1-1/2"

Cast Elbows :

- Chrome plated
- 20 gauge
- Threaded



Item #	U/M	Size
M97096	Each	1-1/4"
M97099	Each	1-1/2"

90 Degree Slip Elbows :

- Chrome plated brass



Item #	U/M	Size
M97092	Each	1-1/4"
M97094	Each	1-1/2"

45 Degree Slip Elbows :

- Chrome plated brass



Item #	U/M	Size
M97093	Each	1-1/4"
M97095	Each	1-1/2"

Dishwasher Branch Tailpiece :

- For 3/4" sweat (7/8" OD) or hose clamp
- 8" Satin finish
- Direct connect inlet



Item # M97050
U/M - Each

Threaded Dishwasher Branch Tailpiece :

- For 3/4" sweat (7/8" OD) or hose clamp
- 8" Satin finish
- Slip joint nut down inlet



Item # M97049
U/M - Each



MILL SUPPLY CO., INC.

Phone (410) 485-3343
Fax (410) 325-2240

Toll Free 1-800-817-8183
Online: www.millsupplyco.com

TUBULAR BRASS / FLEXIBLE COUPLINGS

Slip Joint Nuts :

- Chrome plated



Item #	U/M	IPS	ID
M97153	Each	1-1/4"	1-1/4"
M97159	Each	1-1/2"	1-1/4"
M97155	Each	1-1/2"	1-1/2"
M97157	Each	2"	2"

Ground Joint Connectors :

- Trap tube x outlet
- Straight female iron pipe



Item #	U/M	O.D.	Female IPS
M97355	Each	1-1/4"	1-1/2"
M97356	Each	1-1/2"	1-1/2"

Ground Joint Connectors :

- Trap tube x outlet
- Straight male IPS
- Tapped female copper sweat
- 1-1/2" OD x 1-1/2" MIP



Item # M97353
U/M - Each

Tubular Drain Pipe Connector :

- Connects any combination of 1-1/2" or 1-1/4" brass or plastic drain pipe



Item # M93459
U/M - Each

Flexible Drain And Trap Connectors :

- Connects 1-1/4" or 1-1/2" tubular traps to drain pipe, except copper



Item #	U/M	Pipe size
M93474	Each	2"
M93456	Each	1-1/2"

Flexible Couplings :

- Connects any combination of cast iron, plastic, copper, steel or lead.



Item #	U/M	Size
M93465	Each	1-1/2" x 1-1/2"
M93453	Each	1-1/4" x 1-1/4"
M93462	Each	1-1/2" x 1-1/4"
M93468	Each	1-1/2" x 2"
M93471	Each	2" x 2"
M93485	Each	3" x 3"
M93487	Each	4" x 4"

Slip Joint Washers :

- Black rubber



Item #	U/M	ID	OD	Thick
M97162	Each	1-1/4"	1-1/2"	3/16"
M97164	Each	1-1/2"	1-3/4"	3/16"

Polyethylene Washers :

- White plastic



Item #	U/M	Size
M97174	Each	1-1/4"
M97176	Each	1-1/2"
M97178	Each	1-1/2" x 1-1/4"

Sink Connection Washer :

- Flanged white plastic
- 1-23/32" OD, 1-5/16" ID



Item # M97183
U/M - Each

Quik Caps :



- Easy way to cap pipe ends, cleanouts and open test pipes
- Made of flexible PVC, they're suitable for above ground or underground use
- Use on cast iron, steel, copper or plastic piping
- Convex face allows the cap to withstand greater pressure for testing purposes and minimizes ballooning
- To install, place over open end of pipe and tighten to 60" lbs. torque



Item #	U/M	Size
M93491	Each	1-1/2"
M93492	Each	2"
M93493	Each	3"
M93494	Each	4"



MILL SUPPLY CO., INC.

Phone (410) 485-3343
Fax (410) 325-2240

Toll Free 1-800-817-8183
Online: www.millsupplyco.com

PLUMBING

MAINTENANCE

ELECTRICAL

HARDWARE

CONSTRUCTION & BUILDING SUPPLIES

Tools

LAWN & GARDEN

JANITORIAL

AUTOMOTIVE

PAINT & SUNDRIES

INDUSTRIAL

SAFETY EQUIPMENT

SINKS / LAUNDRY & BATH TUBS

Stainless Steel Kitchen Sink Single Bowl :

- Durable buffed finish
- Sound deadened
- 25" x 22"
- 4 Hole / 6-1/2" Deep
- Includes mounting clips



Item # M90203
U/M - Each

Stainless Steel Kitchen Sink Double Bowl :

- Durable buffed finish
- Sound deadened
- 33" x 22"
- 4 Hole / 6" Deep
- Includes mounting clips



Item # M90201
U/M - Each

Single Laundry Tub Sink :

- For workshop, laundry room, etc.
- One piece construction. heavy gauge, snap-in plastic legs
- Built-in self draining system



Item # M90178
U/M - Each

Double Laundry Tub Sink :

- For workshop, laundry room, etc.
- One piece construction. heavy gauge, snap-in plastic legs
- Built-in self draining system
- 43-1/2"W x 24-1/2" D x 13-1/4" tub height



Item # M90180
U/M - Each

18" Round Porcelain Lavatory Sink :

- Under counter type
- Acid resistant porcelain on steel
- Fits a 4" centerset faucet
- Rimless
- White



Item # M90226
U/M - Each

19" x 16" Oval Porcelain Lavatory Sink :

- Under counter type
- Rimless
- Acid resistant porcelain on steel
- Fits a 4" centerset faucet
- White



Item # M90245
U/M - Each

19" Round Porcelain Lavatory Sink :

- Acid resistant porcelain on steel,
- Fits a 4" centerset faucet
- Installation clamps included
- Self rimming
- White



Item # M90231
U/M - Each

20" x 17" Oval Porcelain Lavatory Sink :

- Acid resistant porcelain on steel,
- Fits a 4" centerset faucet
- Installation clamps included
- Self rimming
- White



Item # M90236
U/M - Each

Wall Hung Lavatory Sink :

- White vitreous china
- 19" x 17" acid resistant extra large bowl
- For 4" centerset faucet
- Includes mounting hanger



Item # M90232
U/M - Each

Lavatory Legs :

- Easy to install
- Chrome plated
- Sold by the pair
- 2-1/2' length



Item # M90184
U/M - Pair

Pedestal Lavatory :

- 20" x 18" oval basin has front overflow, soap depressions, and 4" punchings for 4" faucet centerset
- Wall mounted and supplied concealed hanger and pedestal
- Conforms to ANSI/ASME A-112.19.2M standard
- Pedestal-to-go includes lavatory, base pedestal, supply lines and p-trap
- White



Item # M90249
U/M - Each

Bathtub :

- One piece construction
- Recessed porcelain enameled steel
- 41 Gallon capacity
- Sloped back and patterned slip resistant bottom
- Conforms to ANSI A112.19.4M or, ASTM F-462 slip resistance, or IAPMO (UPC)
- Provided with sound deadening pad
- 5' x 30" x 14- 15/16"
- White



Item #	U/M	Type
M90193	Each	Left Hand
M90194	Each	Right Hand



MILL SUPPLY CO., INC.

Phone (410) 485-3343
Fax (410) 325-2240

Toll Free 1-800-817-8183
Online: www.millsupplyco.com

SINK RIMS / VANITIES / VANITY BASE PROTECTORS

Kitchen Sink Clips :

- Fits most stainless steel sinks
- Sold per pack of 10 only

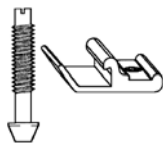

Item # **M90253**
U/M - Pack

Cutting Board :

- Built in tempered glass food preparation center
- Heat resistant for hot cookware
- Impact resistant
- Includes frame and all mounting hardware
- Recessed mount



Item #	U/M	Size
M90555	Each	12" x 15"
M90256	Each	16" x 20"

Sink Rim :

- Stainless steel
- Includes all mounting hardware
- For 19" x 16" oval sinks



Item #	U/M	Size / Type
M90272	Each	18" Round
M90274	Each	19"x16" Oval

Sink & Vanity Base Protectors :



- Can be used in lieu of replacing vanity base due to water damage or installed to prevent water damage
- Makes cabinets look new again
- Installs in less than 5 minutes
- Adjustable width - just slide to fit
- **BATHROOM** model fits 20"-39-1/2" wide x 18"-19" deep
- **KITCHEN** model fits 22"-42" wide x 22"-24" deep



Item #	U/M	Type
M76419	Each	Bathroom
M76423	Each	Kitchen

Vanity Top :

- Made of fine cultured marble
- White on white color
- Recessed oval bowl style
- Accepts 4" centerset standard lavatory faucets



Item #	U/M	Size
M76277	Each	25" x 22"
M76290	Each	31" x 22"
M76303	Each	37" x 22"
M76316	Each	49" x 22"

Universal Side/End Splash :

- Made of fine cultured marble
- White on white color
- For left or right hand applications
- 22" Length - 4" Height



Item # **M76405**
U/M - Each

Vanity Base :

- Solid 3/4" face frame and doors
- 1/2" plywood sides and bottom
- Pre-assembled door and hinges
- Rich finish inside and out
- Heavy European concealed hinges
- Pre-installed metal clips for quick and easy assembly



Oak			
Item #	U/M	Description	Size
M76048	Each	Two Door	24" w x 21" d
M76052	Each	Two Door	30" w x 21" d
M76054	Each	One Door / Two Drawer	30" w x 21" d
M76057	Each	Two Door / Two Drawer	36" w x 21" d
M76059	Each	Two Door / Four Drawer	48" w x 21" d

White			
Item #	U/M	Description	Size
M76007	Each	Two Door	24" w x 21" d
M76013	Each	Two Door	30" w x 21" d
M76015	Each	One Door / Two Drawer	30" w x 21" d
M76019	Each	Two Door / Two Drawer	36" w x 21" d
M76025	Each	Two Door / Four Drawer	48" w x 21" d

*Vanities can be assembled for a small upcharge.



MILL SUPPLY CO., INC.

Phone (410) 485-3343
Fax (410) 325-2240

Toll Free 1-800-817-8183
Online: www.millsupplyco.com

PLUMBING

MAINTENANCE

ELECTRICAL

HARDWARE

CONSTRUCTION & BUILDING SUPPLIES

Tools

LAWN & GARDEN

JANITORIAL

AUTOMOTIVE

PAINT & SUNDRIES

INDUSTRIAL

SAFETY EQUIPMENT

FAUCETS

Single Handle Kitchen Faucet With Pull-Out Spout :

- Ceramic cartridge
- Chrome finish
- Includes deck plate / Can be used in 1 or 3 hole applications
- 1/2" IPS connections



Item # M90281
U/M - Each

Single Handle Kitchen Faucet :

- Metal body / Metal handle / **Less Spray**
- 8" center
- Heavy Chrome plating
- 1/2" IPS connections



Item # M90282
U/M - Each

Single Handle Kitchen Faucet :

- Metal body / Metal handle / **With Spray**
- 8" center
- Heavy Chrome plating
- 1/2" IPS connections



Item # M90285
U/M - Each

Two Handle Kitchen Faucet :

- Metal handles / **Less Spray**
- 8" center
- Heavy Chrome plating / Metal body
- 1/2" IPS connections



Item # M90287
U/M - Each

Two Handle Kitchen Faucet :

- Acrylic handles / **Less Spray**
- 8" center
- Heavy Chrome plating / Metal body
- 1/2" IPS connections



Item # M90288
U/M - Each

Two Handle Kitchen Faucet :

- Acrylic handles / **With Spray**
- 8" center
- Heavy Chrome plating / Metal body
- 1/2" IPS connections



Item # M90290
U/M - Each

Two Handle Lavatory Faucet :

- Solid brass lever handles
- Metal body / Chrome finish
- 1/2" IPS connections
- With metal pop-up
- ADA compliant



Item # M90313
U/M - Each

Two Handle Lavatory Faucet :

- Blade lever handles
- Metal body / Chrome finish
- 1/2" IPS connections
- ADA compliant



Item # M90311
U/M - Each



MILL SUPPLY CO., INC.

Phone (410) 485-3343
Fax (410) 325-2240

Toll Free 1-800-817-8183
Online: www.millsupplyco.com

FAUCETS

Single Handle Lavatory Faucet :

- Metal handle / 4" center
- Heavy chrome plating / Metal body
- 1/2" IPS connections
- With metal pop-up



Item # M90301
U/M - Each



Single Handle Lavatory Faucet :

- Acrylic handle / 4" center
- Heavy Chrome plating / Metal body
- 1/2" IPS connections
- Less pop-up



Item # M90292
U/M - Each

Single Handle Lavatory Faucet :

- Acrylic handle / 4" center
- Heavy Chrome plating / Metal body
- 1/2" IPS connections
- With metal pop-up



Item # M90294
U/M - Each

Two Handle Lavatory Faucet :

- Metal handles / 4" center
- Heavy chrome plating / Metal body
- 1/2" IPS connections
- With metal pop-up



Item # M90295
U/M - Each

Two Handle Lavatory Faucet :

- Acrylic handles / 4" center
- Heavy chrome plating / Metal body
- 1/2" IPS connections
- Less pop-up



Item # M90304
U/M - Each

Two Handle Lavatory Faucet :

- Acrylic handles / 4" center
- Metal body
- 1/2" IPS connections
- With metal pop-up



Item # M90298
U/M - Each

Laundry Tray Faucet :

- 4" Ledge type
- 1/2" I.P.S. shanks
- Chrome plated finish
- Solid brass body
- 6" Spout
- Blade handles



Item # M90536
U/M - Each

Laundry Tray Faucet :

- 4" Centers
- 1/2" I.P.S. unions
- Rough brass
- 6" Spout
- Lever handles
- Tub or wall mount



Item # M90540
U/M - Each



MILL SUPPLY CO., INC.

Phone (410) 485-3343
Fax (410) 325-2240

Toll Free 1-800-817-8183
Online: www.millsupplyco.com

- PLUMBING
- MAINTENANCE
- ELECTRICAL
- HARDWARE
- CONSTRUCTION & BUILDING SUPPLIES
- Tools
- LAWN & GARDEN
- JANITORIAL
- AUTOMOTIVE
- PAINT & SUNDRIES
- INDUSTRIAL
- SAFETY EQUIPMENT

TUB SHOWER & MOEN FAUCETS

Two Handle Tub/Shower Faucet :

- Compression style valve with solid brass stem and bonnet provide time tested reliability
- Metal handles
- Solid brass waterways
- 1/2" IPS or CXC inlet includes all trim
- Oversized adjustable shower head
- 2.5gpm Flow rate
- Replacement stem #M91027



Item # M90510
U/M - Each

Three Handle Tub/Shower Faucet :

- Compression style valve with solid brass stem and bonnet provide time tested reliability
- Metal handles
- Solid brass waterways
- 1/2" IPS or CXC inlet includes all trim
- Oversized adjustable shower head
- 2.5gpm Flow rate
- Replacement H/C stem #M91027
- Replacement Diverter stem #M91025



Item # M90507
U/M - Each

Kitchen Faucet With Pull-Out Spout :

- Pull-out spout includes 59" hose for added reach and convenience
- Hydrolock quick connect installation
- 1 or 3 hole application can be single hole mounted
- 1/2" IPS connection
- Water/energy saving aerator 2.2gpm
- Chrome finish
- Lifetime warranty



Item # M90401
U/M - Each

Single Lever Kitchen Faucet :

- Contemporary styling
- Concealed self-sealing gasket requires no putty
- 8" centers
- 1/2" IPS connection
- Water/energy saving aerator 2.2gpm
- Chrome finish
- Less spray
- Lifetime warranty



Item # M90413
U/M - Each

Two Handle Kitchen Faucet :

- Contemporary styling
- Concealed self-sealing gasket requires no putty
- 8" centers
- 1/2" IPS connection
- Water/energy saving aerator 2.2gpm
- Chrome finish
- Less spray
- Lifetime warranty



Item # M90421
U/M - Each

Single Lever Kitchen Faucet :

- Contemporary styling
- Concealed self-sealing gasket requires no putty
- 8" centers
- 1/2" IPS connection
- Water/energy saving aerator 2.2gpm
- Chrome finish
- With spray
- Lifetime warranty



Item # M90416
U/M - Each



MILL SUPPLY CO., INC.

Phone (410) 485-3343
Fax (410) 325-2240

Toll Free 1-800-817-8183
Online: www.millsupplyco.com

MOEN FAUCETS

Single Handle Lavatory Faucet :



- 4" Center, 1/2" IPS, washerless
- Water/energy saving aerator
- Chrome finish
- Less pop-up
- Lifetime warranty



Item # M90407
U/M - Each

Single Handle Lavatory Faucet :



- 4" Center, 1/2" IPS, washerless
- Water/energy saving aerator
- Chrome finish
- With pop-up
- Lifetime warranty



Item # M90410
U/M - Each

Two Handle Lavatory Faucet :



- 4" Center, 1/2" IPS, washerless
- Water/energy saving aerator
- Chrome finish
- With pop-up
- Lifetime warranty



Item # M90423
U/M - Each

Posi-Temp Tub Shower Control CxC:



- Adjustable temperature limit stop allows pre-selection of maximum hot water temperature
- Pressure balancing cycling valve - balances hot & cold water pressure
- Maintains water temperature to within 2 degrees F.
- Stops shower shock
- Supply and discharge ports are 1/2" CXC
- Designed to meet code requirements
- Chrome finish
- Includes showerhead, arm & flange and tub diverter spout
- Lifetime warranty



Item # M90408
U/M - Each

Posi-Temp Shower Control :



- Same specs as the Posi-Temp tub shower valve. Our #M90404
- Does not include tub diverter spout
- Chrome finish
- Lifetime warranty



Item # M90405
U/M - Each

Posi-Temp Tub Shower Control IPS:



- Adjustable temperature limit stop allows pre-selection of maximum hot water temperature
- Pressure balancing cycling valve - balances hot & cold water pressure
- Maintains water temperature to within 2 degrees F.
- Stops shower shock
- Supply and discharge ports are 1/2" IPS
- Designed to meet code requirements
- Chrome finish
- Includes showerhead, arm & flange and tub diverter spout
- Lifetime warranty
- ADA Compliant



Item # M90404
U/M - Each



MILL SUPPLY CO., INC.

Phone (410) 485-3343
Fax (410) 325-2240

Toll Free 1-800-817-8183
Online: www.millsupplyco.com

PLUMBING

MAINTENANCE

ELECTRICAL

HARDWARE

CONSTRUCTION & BUILDING SUPPLIES

Tools

LAWN & GARDEN

JANITORIAL

AUTOMOTIVE

PAINT & SUNDRIES

INDUSTRIAL

SAFETY EQUIPMENT

PLUMBING

MAINTENANCE

ELECTRICAL

HARDWARE

CONSTRUCTION & BUILDING SUPPLIES

Tools

LAWN & GARDEN

JANITORIAL

AUTOMOTIVE

PAINT & SUNDRIES

INDUSTRIAL

SAFETY EQUIPMENT

DELTA FAUCETS

Classic Single Handle Kitchen Faucet :



- 3 Hole installation
- 8" Center
- 8" Long spout swings 360°
- Lever handle
- Chrome
- 1/2" IPS connections
- Mfg #100 DST
- ADA Compliant



Item # M90353
U/M - Each

Twin Handle Kitchen Faucet :



- 3 Hole installation
- 8" Center
- 8" Long spout swings 360°
- Acrylic handles
- Red & blue handle indicators
- 1/2" IPS connections
- Chrome
- Mfg #2102



Item # M90365
U/M - Each

Single Handle Lavatory Faucet :



- 3 Hole installation
- 4" Centerset
- Acrylic handle
- Chrome
- Metal pop-up
- 1/2" IPS connections
- Mfg #522WFMPU



Item # M90383
U/M - Each

Twin Handle Lavatory Faucet :



- 3 Hole installation
- 4" Centerset
- Acrylic handles
- Red & Blue handle indicators
- Chrome
- With pop-up
- 1/2" IPS connections
- Mfg #2522



Item # M90368
U/M - Each

Twin Handle Lavatory Faucets :



- 2 & 3 Hole installation
- 4" Centerset
- Blade handles
- Chrome
- With pop-up
- 1/2" IPS connections
- Mfg #2520



Item # M90371
U/M - Each

Single Handle Lavatory Faucet :



- 3 Hole installation
- 4" Centerset
- Lever handle
- Chrome
- With pop-up
- 1/2" IPS connections
- Mfg #520WF



Item # M90380
U/M - Each



MILL SUPPLY CO., INC.

Phone (410) 485-3343
Fax (410) 325-2240

Toll Free 1-800-817-8183
Online: www.millsupplyco.com

SPECIALTY FAUCETS & POP-UPS

Pop-Up Drain Assemblies :

- Lift rod, plunger and linkage included



Item #	U/M	Description
M91296	Each	Non-metallic
M91294	Each	Chrome plated brass

Pop-Up Linkage Set :

- Fits most pop-up drain assemblies
- 3 piece set includes; lift rod, ball crank & nut and rod strap
- Chrome plated lift rod



Item # M91290
U/M - Each

Pop-Up Mack Gasket :

- 1-1/4" ID, 2" OD
- Black rubber
- Replaces a worn or damaged Mack Gasket in pop-up drain assembly



Item # M92166
U/M - Each

Temperature & Pressure Relief Valve :

- Replacement for *Watts Regulator Model 100XL-4
- *Cash Acme Model NCLX-5
- 150psi / 210 degree F.
- 3/4" Male inlet / 3/4" Female outlet



Item # M99756
U/M - Each

Sillcock :

- Heavy brass construction
- Notched flange for stable installation
- 3/4" Hose thread outlet



Item #	U/M	IP Size
M99720	Each	1/2"
M99721	Each	3/4"

Boiler Drain :

- Heavy brass construction
- Heavy cast iron handle
- 3/4" Hose thread outlet
- Male inlet pictured



Item #	U/M	Inlet Size / Type
M99906	Each	1/2" Male
M99907	Each	3/4" Male
M99908	Each	1/2" Female



MILL SUPPLY CO., INC.

Phone (410) 485-3343
Fax (410) 325-2240

Toll Free 1-800-817-8183
Online: www.millsupplyco.com

PLUMBING

MAINTENANCE

ELECTRICAL

HARDWARE

CONSTRUCTION & BUILDING SUPPLIES

Tools

LAWN & GARDEN

JANITORIAL

AUTOMOTIVE

PAINT & SUNDRIES

INDUSTRIAL

SAFETY EQUIPMENT

POP-UP STOPPERS

Fits Most :

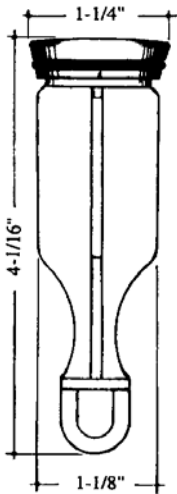

Item # M91300
U/M - Each

Fits American Standard :

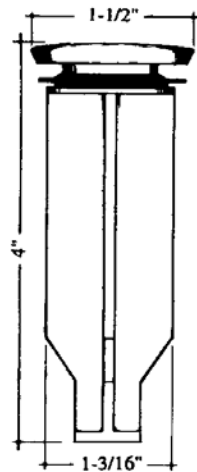

Item # M91301
U/M - Each

Fits Kohler :

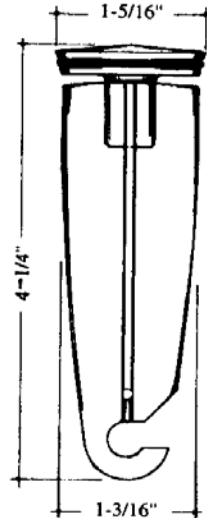

Item # M91303
U/M - Each

Fits Kohler :

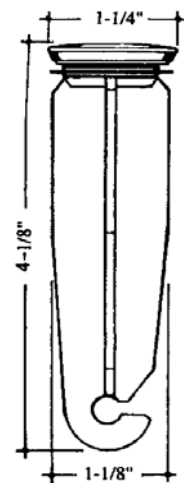

Item # M91304
U/M - Each

Fits Delta :

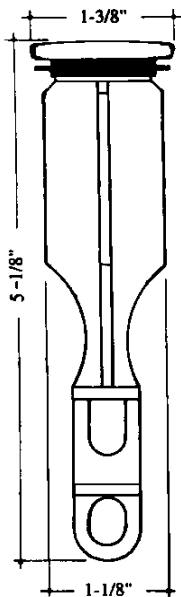

Item # M91305
U/M - Each

Fits Moen :

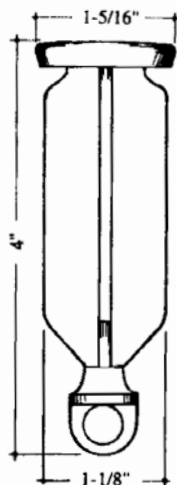

Item # M91309
U/M - Each

Fits Price Pfister :

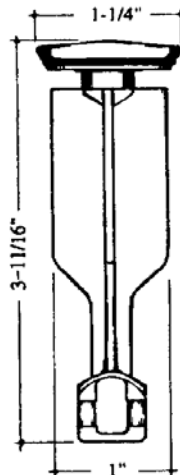

Item # M91311
U/M - Each

Fits Sterling :

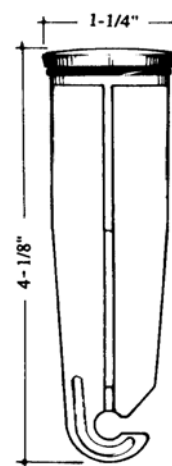

Item # M91307
U/M - Each

**Universal
"Flip-It"
Fits all :**

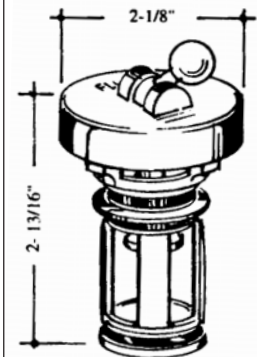

Item # M91210
U/M - Each

The illustrations on this page are the property of Kissler & Company Inc. A registered copyright has been filed with the Library of Congress (Copyright Office) Division of The United States Government. No attempt to copy any of these illustrations should be made without the express written permission of Kissler & CO.



MILL SUPPLY CO., INC.

Phone (410) 485-3343
Fax (410) 325-2240

Toll Free 1-800-817-8183
Online: www.millsupplyco.com

REPAIR PARTS FOR DELTA *

Delta OEM



Lavatory Handle :

- Acrylic
- Includes button and screw
- Fits all lav. that use 212 type ball
- OEM# RP2389 or RP17449



Item # M90680
U/M - Each

Replacement Handle Set :

- Acrylic canopy
- Includes buttons and screws
- Replaces lav., kitchen or tub handles
- Replaces #RP5693
- Also replaces many imported lavatory and kitchen faucet handles
- Sold by the pair only



Item # M90683
U/M - Pair

Replacement Index Buttons :

- Plastic
- Fits Delta and many imported faucets



Item #	U/M	Type
M90681	Each	Hot
M90682	Each	Cold

Replacement Stem :

- Plastic
- Fits Delta and many imported faucets
- Replaces #RP1740



Item # M90656
U/M - Each

Control Ball :

- M90659 brass ball replacement for crystal handles
- M90660 stainless steel ball replacement for lever handles



Item #	U/M	Replaces
M90659	Each	#RP212
M90660	Each	#RP70

Seats & Springs :

- Contains 2 complete sets of both old and new style springs and TPR seats
- Replaces #RP134 & #RP4993



Item # M90665
U/M - Each

Delta OEM



Diverter

Assembly :

- For single handle kitchen deck faucets
- OEM# RP320



Item # M90671
U/M - Each

Delta OEM



Repair Kit :

- Delta OEM# RP3614
- Includes; new style TPR seats and springs, 2/ea teflon lined cams, spout O-rings, and faucet wrench
- Sold as a complete set



Item # M90674
U/M - Each

Generic Repair Kit :

- For all Delta type lavatory, tub and shower faucets
- Includes; old and new style TPR seats and springs, 2/ea teflon lined cams, spout O-rings, and faucet wrench
- Sold as a complete set



Item # M90668
U/M - Each

Replacement Delta Spout :

- For single handle type faucets
- 8" Swing spout
- Chrome plated
- Replaces Delta OEM# RP5654



Item # M90685
U/M - Each

* Brand names, model names, original manufactures' name or stock numbers, which may appear on seller's invoices, catalogs, packages, quotations or correspondence, are so utilized for the purposes of identification only; and are not a warranty or representation, either express or implied, that items offered or sold are genuine products of such original manufacturers.



MILL SUPPLY CO., INC.

Phone (410) 485-3343
Fax (410) 325-2240

Toll Free 1-800-817-8183
Online: www.millsupplyco.com

PLUMBING

MAINTENANCE

ELECTRICAL

HARDWARE

CONSTRUCTION & BUILDING SUPPLIES

Tools

LAWN & GARDEN

JANITORIAL

AUTOMOTIVE

PAINT & SUNDRIES

INDUSTRIAL

SAFETY EQUIPMENT

PLUMBING

MAINTENANCE

ELECTRICAL

HARDWARE

CONSTRUCTION & BUILDING SUPPLIES

Tools

LAWN & GARDEN

JANITORIAL

AUTOMOTIVE

PAINT & SUNDRIES

INDUSTRIAL

SAFETY EQUIPMENT

REPAIR PARTS FOR MOEN *

Genuine Moen Cartridges :

- Repairs most leaks and restores faucet action to like new condition
- Made in U.S.A.



Brass

Plastic



Item #	U/M	Description	Mfg #
M90802	Each	Brass body	1200
M90812	Each	Plastic Body	1225

Replacement Cartridges for Moen :

- A low cost alternative to genuine cartridges
- Imported



Brass

Plastic

Item #	U/M	Description
M90801	Each	Brass Body
M90811	Each	Plastic Body

Posi-Temp Cartridge :

- Moen OEM# 1222
- Replacement cartridge for Moen Posi-Temp tub and shower faucets



Item # **M90813**
U/M - Each

Posi-Temp Handle :

- Replacement for Moen Posi-Temp Shower handle
- Replaces #100710



Item # **M90832**
U/M - Each

Teardrop Lavatory Handle :

- Short broach
- Includes button & screw
- Replaces #96791 or #96782 Chateau



Item # **M90815**
U/M - Each

Teardrop Tub Handle :

- Long broach
- Includes button & screw
- Replaces #96797 or #98039 Chateau



Item # **M90822**
U/M - Each

Round Lavatory Handle :

- Short broach
- Includes button & screw
- Replaces #13092 or #98024 Legend



Item # **M90817**
U/M - Each

Round Tub Handle :

- Long broach
- Includes button & screw
- Replaces #13094 or #98025 Legend / Moentrol



Item # **M90810**
U/M - Each

* Brand names, model names, original manufacturers' name or stock numbers, which may appear on seller's invoices, catalogs, packages, quotations or correspondence, are so utilized for the purposes of identification only; and are not a warranty or representation, either express or implied, that items offered or sold are genuine products of such original manufacturers.



MILL SUPPLY CO., INC.

Phone (410) 485-3343
Fax (410) 325-2240

Toll Free 1-800-817-8183
Online: www.millsupplyco.com

REPAIR PARTS FOR MOEN *

Repair Kit #1 :

- For Moen **plastic** type cartridges
- Includes; 2 side seals, 3/ea large O-rings and 4/ea small O-rings



Item # M90830
U/M - Each

Repair Kit #2 :

- For Moen **brass** type cartridges
- Includes; 1/ea retainer clip, 3/ea #11 and 1/ea #12 O-rings.



Item # M90639
U/M - Each

O-Ring Repair Kit #2 :

- Contains 2/ea lower #16 and 1/ea #44 spout o-rings
- Fits most single handle Moen Chalet and Chateau series and Zeigler Harris
- Sold per pack



Item # M90647
U/M - Pack

Ceramic Disc Cartridge :



- Genuine Moen replacement part
- Mfg # 4000
- Replacement cartridge for # 7100, 7106, 7100, 7175, 87002, 87005, 87006, 87007, 87520, 87526, 87534, 87538, 87551, 87666 and 87845 faucets



Item # M90803
U/M - Each

Cap & Handle Assembly New Style :

- Fits "New Style" Moen Chateau series faucets
- Replaces #96790 & 10927



Item # M90807
U/M - Each

Cap & Cover Assembly :

- Includes cap, cover and screw
- For Chateau series
- Replaces #96790



Item # M90806
U/M - Each

* Brand names, model names, original manufacturers' name or stock numbers, which may appear on seller's invoices, catalogs, packages, quotations or correspondence, are so utilized for the purposes of identification only; and are not a warranty or representation, either express or implied, that items offered or sold are genuine products of such original manufacturers.



MILL SUPPLY CO., INC.

Phone (410) 485-3343
Fax (410) 325-2240

Toll Free 1-800-817-8183
Online: www.millsupplyco.com

PLUMBING

MAINTENANCE

ELECTRICAL

HARDWARE

CONSTRUCTION & BUILDING SUPPLIES

Tools

LAWN & GARDEN

JANITORIAL

AUTOMOTIVE

PAINT & SUNDRIES

INDUSTRIAL

SAFETY EQUIPMENT

STEMS ARE SOLD WITH BONNETS BY THE EACH
STEMS ARE ACTUAL SIZE

STEMS

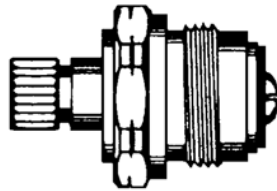
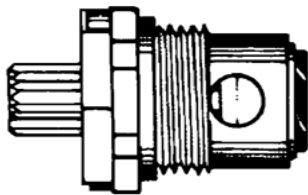
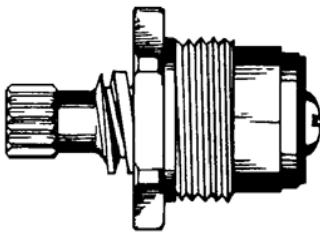
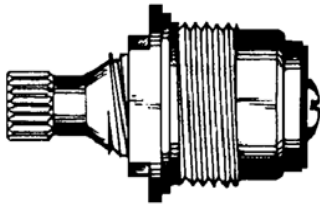
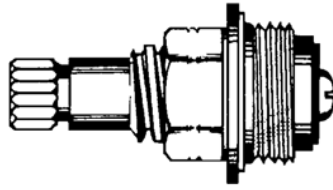

Replacement Stem for :Kohler	Union Brass	Gerber - Old Style	Gerber - New Style	Price Pfister
Item # M91033 RH- Hot	Item # M91036 RH- Hot	Item # M91003 RH- Hot	Item # M91005 RH- Hot	Item # M91011
Item # M91034 LH- Cold	Item # M91037 LH- Cold	Item # M91002 LH- Cold	Item # M91004 LH- Cold	RH- Hot/Cold
Replacement Seat				
Item # M91035 1/2-27T	N/A	Item # M91006 5/8 - 20T	Item # M91006 5/8 - 20T	Item # M91012 1/2 - 20T
Replacement Washer				
Item # M90583 "00" Flat	N/A	Item # M90589 1/4 Flat	Item # M90589 1/4 Flat	Item # M90583 "00" Flat

The illustrations on this page are the property of Kissler & Company Inc. A registered copyright has been filed with the Library of Congress (Copyright Office) Division of The United States Government. No attempt to copy any of these illustrations should be made without the express written permission of Kissler & CO.



MILL SUPPLY CO., INC.

Phone (410) 485-3343
 Fax (410) 325-2240

Toll Free 1-800-817-8183
 Online: www.millsupplyco.com

STEMS

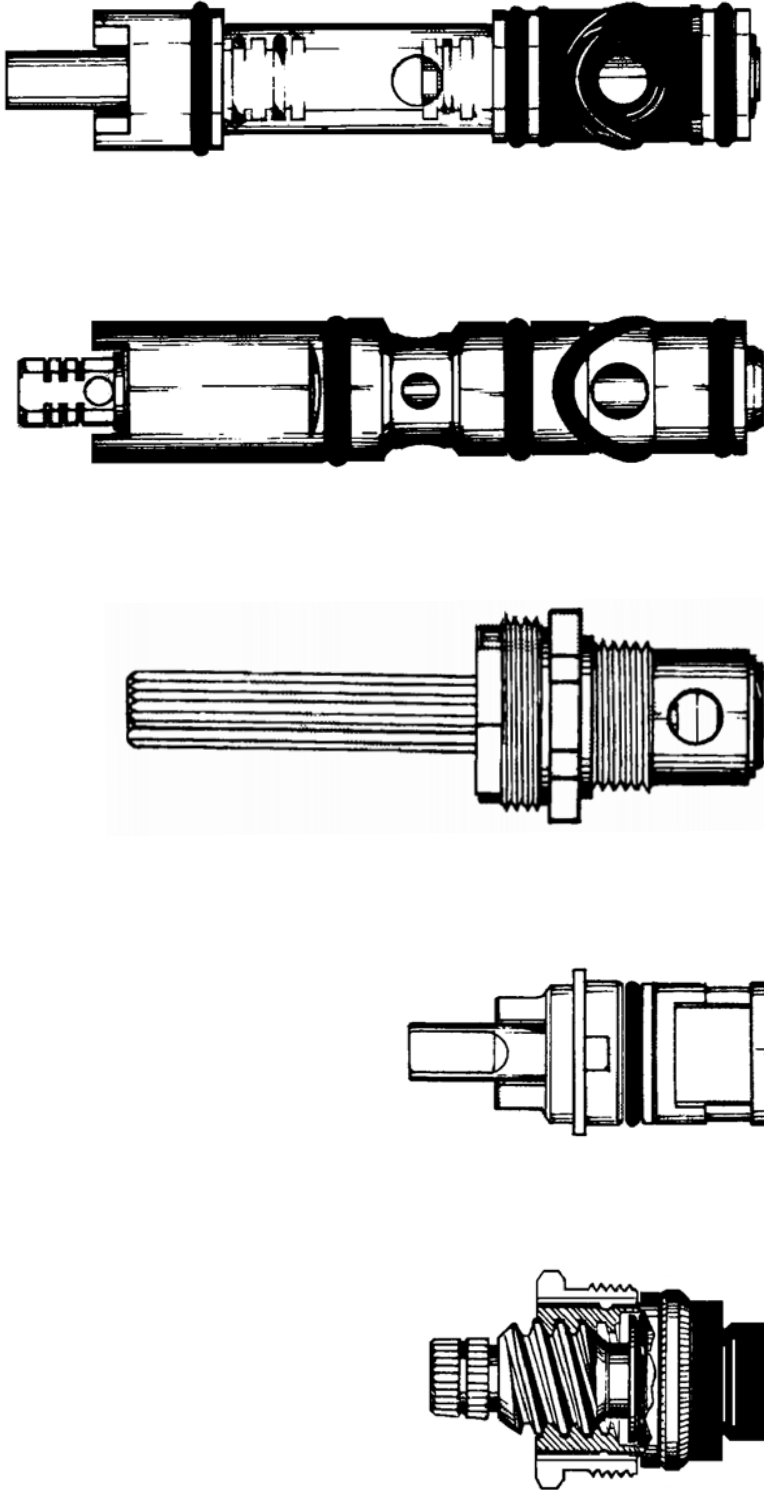

American Standard	Delta	Union Brass	Moen	Moen
Item # M91007 RH- Hot	Item # M90656 RH- Hot/Cold	Item # M91010 RH- Hot/Cold	Item # M90802 OEM	Item # M90812 OEM
Item # M91008 LH - Cold	Item # M90665 Both Styles	N/A	Item # M90801 Generic	Item # M90811 Generic
Replacement Seat	Item # M91009 7/16-24T	N/A	N/A	N/A
Replacement Washer	N/A	N/A	N/A	N/A
Item # M91043 Aqua Seal				

The illustrations on this page are the property of Kissler & Company Inc. A registered copyright has been filed with the Library of Congress (Copyright Office) Division of The United States Government. No attempt to copy any of these illustrations should be made without the express written permission of Kissler & CO.



MILL SUPPLY CO., INC.

Phone (410) 485-3343
Fax (410) 325-2240

Toll Free 1-800-817-8183
Online: www.millsupplyco.com

PLUMBING

MAINTENANCE

ELECTRICAL

HARDWARE

CONSTRUCTION & BUILDING SUPPLIES

Tools

LAWN & GARDEN

JANITORIAL

AUTOMOTIVE

PAINT & SUNDRIES

INDUSTRIAL

SAFETY EQUIPMENT

STEMS

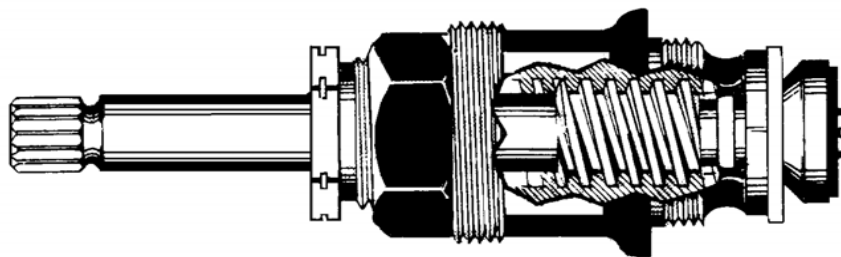
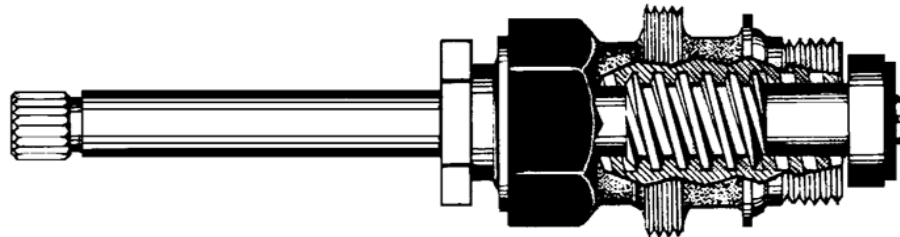
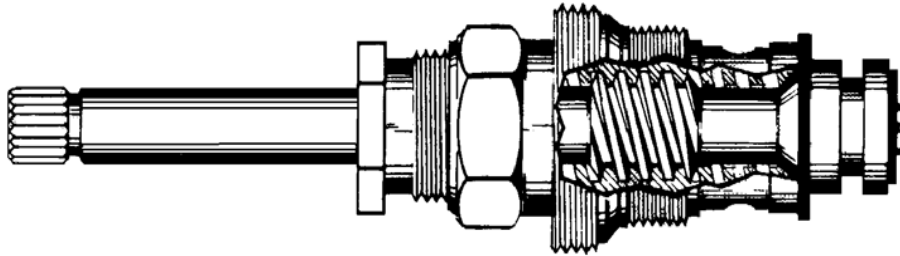
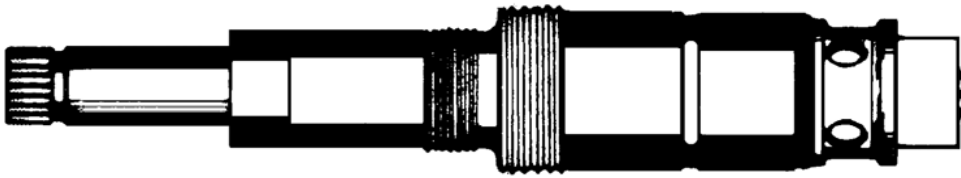

Price Pfister	American Standard	Sterling	American Standard
Item # M91023 RH - Diverter	Item # M91041 RH- Hot/Cold	Item # M91019 RH- Hot/Cold	Item # M91040 RH - Diverter
Replacement Seat Item # M91024 2 1/32 - 18T	Item # M91042 1/2 - 20T	Item # M91020 1/2 - 24T	Item # M91042 1/2 - 20T
Replacement Washer Item # M90601 3/8L Flat	Item # M90586 "0" Flat	Item # M90592 1/4L Flat	Item # M91014

The illustrations on this page are the property of Kissler & Company Inc. A registered copyright has been filed with the Library of Congress (Copyright Office) Division of The United States Government. No attempt to copy any of these illustrations should be made without the express written permission of Kissler & CO.



MILL SUPPLY CO., INC.

Phone (410) 485-3343
Fax (410) 325-2240

Toll Free 1-800-817-8183
Online: www.millsupplyco.com

The illustrations on this page are the property of Kissler & Company Inc. A registered copyright has been filed with the Library of Congress (Copyright Office) Division of The United States Government. No attempt to copy any of these illustrations should be made without the express written permission of Kissler & CO.

STEMS

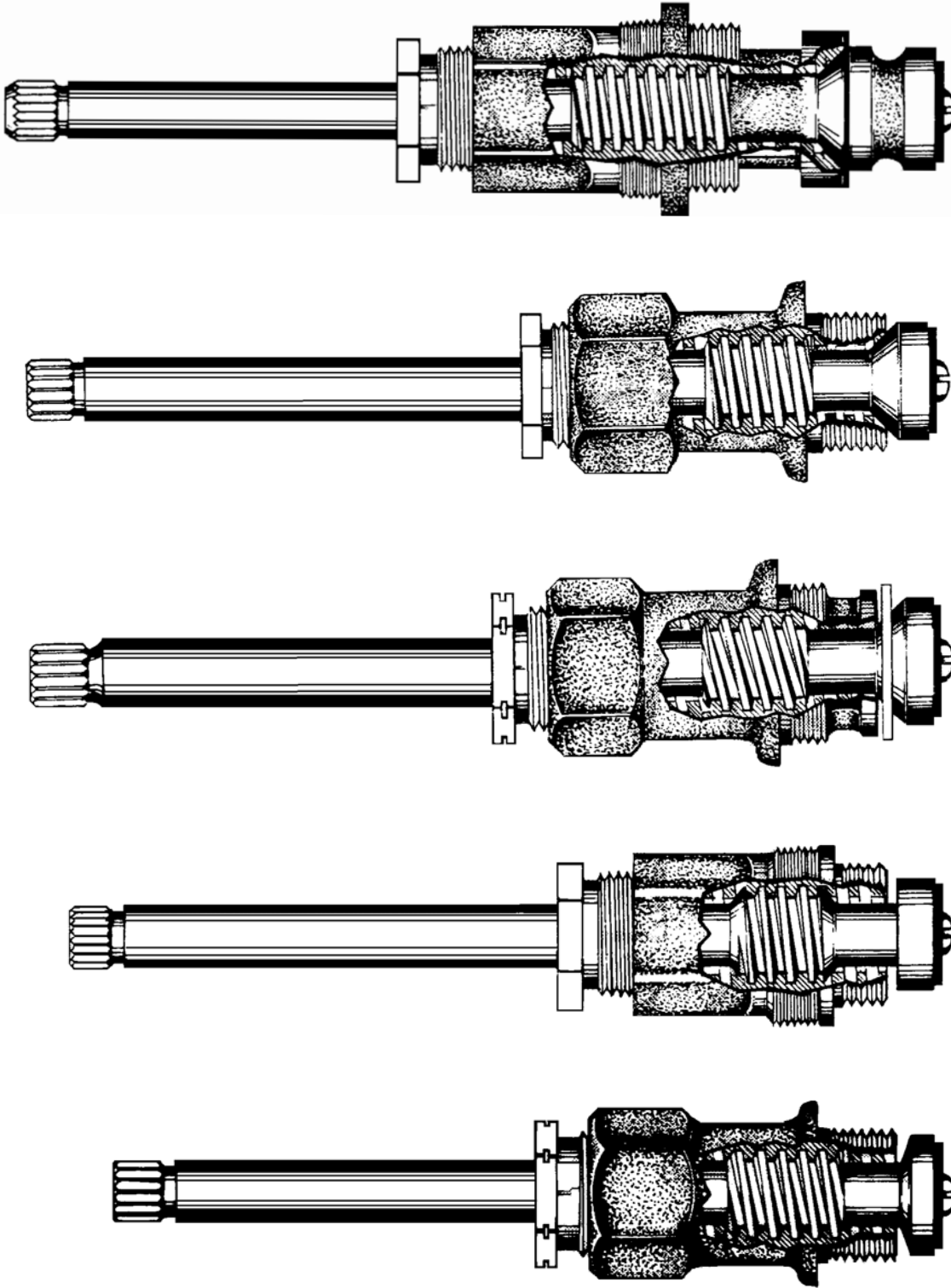

Price Pfister	Gerber	Price Pfister	Gerber
Item # M91031 RH - Hot/Cold Replacement Seat	Item # M91017 RH - Hot/Cold	Item # M91027 RH - Hot/Cold	Item # M91029 RH - Diverter
Item # M91024 21/32 - 18T Replacement Washer	Item # M91006 5/8 - 20T	Item # M91024 21/32 - 18T	Item # M91006 5/8 - 20T
Item # M90592 1/4L Flat	Item # M90592 1/4L Flat	Item # M90601 3/8L Flat	Item # M90592 1/4L Flat



MILL SUPPLY CO., INC.

Phone (410) 485-3343
Fax (410) 325-2240

Toll Free 1-800-817-8183
Online: www.millsupplyco.com

PLUMBING

MAINTENANCE

ELECTRICAL

HAIRDWARE

CONSTRUCTION
BUILDING
SUPPLIES

Tools

LAWN &
GARDEN

DIY/TUTORIAL

AUTOMOTIVE

PAINT &
FURNITURE

INDUSTRIAL

SAFETY
EQUIPMENT

PLUMBING

MAINTENANCE

ELECTRICAL

HARDWARE

CONSTRUCTION & BUILDING SUPPLIES

Tools

LAWN & GARDEN

JANITORIAL

AUTOMOTIVE

PAINT & SUNDRIES

INDUSTRIAL

SAFETY EQUIPMENT

FAUCET REPAIR PARTS

Faucet O-Ring Kit :

- Contains 200 assorted O-Rings
- 12 most common sizes used in the plumbing industry



Item # M90648
U/M - Each

American Standard Washer :

- Fits Aqua Seal
- Replaces # 72960-07



Item # M91043
U/M - Each

Bib Washers :

- Actual size
- Sold in packs of 100 only



FLAT BEVELED

Trade Size	U/M	Flat	Beveled
"00"	Pack	M90583	M90578
"0"	Pack	M90586	M90562
1/4	Pack	M90589	M90565
1/4L	Pack	M90592	M90568
3/8	Pack	M90595	M90571
3/8L	Pack	M90601	M90559
1/2	Pack	M90604	M90558
5/8	Pack	M90607	M90561
Assorted	Pack	M90577	M90556

Sterling Diverter Handle :

- Replacement shower diverter handle for Sterling
- 1-1/4" height
- Chrome finish
- 16 point broach
- Screw included
- Sold per each



Item # M90971
U/M - Each

Sterling Blade Handles :

- Replacement kitchen, lavatory and tub / shower handles for Sterling
- 1-1/4" height
- Chrome finish
- 16 point broach
- Screws included
- Sold per pair only



Item # M90999
U/M - Pair

Sterling Cross Handles :

- Replacement kitchen, lavatory and tub / shower handles for Sterling
- 1-1/4" height
- Chrome finish
- 16 point broach
- Screws included
- Sold per pair only



Item # M90972
U/M - Pair

Bib Seats :

Sold in packs of 10 only

Fits American Standard :

- 7/16-24T
- Replaces OEM #862-14
- 11/32" height



Item # M91009
U/M - Pack

Fits American Standard :

- 1/2-20T
- Replaces OEM #57281-07
- 7/16" height



Item # M91042
U/M - Pack

Fits Gerber :

- 5/8-20T
- Replaces OEM #90-161
- 7/16" height



Item # M91006
U/M - Pack

Fits Kohler :

- 1/2-27T
- Replaces OEM #20774-RP
- 5/16" height



Item # M91035
U/M - Pack

Fits Price Pfister :

- 1/2-20T
- Replaces OEM #970-510
- 3/8" height



Item # M91012
U/M - Pack

Fits Price Pfister :

- 21/32-18T
- Replaces OEM #970-500
- 3/8" height



Item # M91024
U/M - Pack

Fits Sterling :

- 1/2-24T
- Replaces OEM #995-0369
- 3/8" height



Item # M91020
U/M - Pack



MILL SUPPLY CO., INC.

Phone (410) 485-3343
Fax (410) 325-2240

Toll Free 1-800-817-8183
Online: www.millsupplyco.com

TOILET REPAIR PARTS

Spud Washers :

- Flanged
- Rubber



Item #	U/M	Size
M92339	Each	1-1/2"
M92343	Each	2"

Brass Spuds :

- Rough brass



Item #	U/M	Size
M92345	Each	1" x 3/4"
M92347	Each	1-1/2"
M92351	Each	2"

Tank-To-Bowl Gaskets :

- Sponge rubber



Item #	U/M	Description
M92168	Each	Std. 3-1/4" OD
M92188	Each	For Eljer
M92186	Each	For Gerber
M92173	Each	For American Std.
M92183	Each	For Crane

Closet Bowl Wax Rings :

- Fit-All
- Plastic sleeve fits 3" x 4" waste line
- For floor type closet bowls



Item #	U/M	Type
M92159	Each	less flange
M92151	Each	with flange

Heavy Duty Closet Bowl Wax Ring :

- 40% more wax than other gaskets
- Save labor time on installations and makes for positive seal



Item # M92154
U/M - Each

Wax Free Toilet Seal :

- Easy, no fuss, 1 piece design
- Quick and easy 2 step installation
- Clean to install with NO MESSY WAX
- Gas and water tight
- Seals to the toilet flange below the floor
- Strong seal that will not break even if the toilet backs up
- Connects toilet to a 4"x3" combination flange



Item # M92146
U/M - Each

Plastic Toilet Shims :

- Used for leveling closet bowls
- Ribbed for stacking
- 4 shims per pack
- Sold per pack only



Item # M92233
U/M - Pack

Spanner Flange :

- Eliminates the need to replace broken cast iron or plastic ring
- Suitable for use with cast iron, plastic, copper and brass closet flange



Item # M92228
U/M - Each

Closet Flange Spacer :

- Builds up an existing closet flange when new flooring is installed
- For ABS or PVC closet flanges
- Can be stacked to desired height
- 1/4" height
- Sold per each



Item # M92230
U/M - Each

PVC Closet Flange :

- Fits on 3" or 4" PVC
- Deep seal
- Schedule 40 PVC
- Standard pattern
- Without stop or knocker
- 4" x 3" hub



Item # M93755
U/M - Each

Cast Iron Flange Replacement :

- Slides inside of 4" cast iron or Sch. 40 DWV plastic pipe
- 3" stainless steel bolts are tightened from the finished floor
- Compression joint allows up to 3" of adjustment to the riser
- No tearout or caulking required



Item # M93756
U/M - Each



MILL SUPPLY CO., INC.

Phone (410) 485-3343
Fax (410) 325-2240

Toll Free 1-800-817-8183
Online: www.millsupplyco.com

PLUMBING

MAINTENANCE

ELECTRICAL

HARDWARE

CONSTRUCTION & BUILDING SUPPLIES

Tools

LAWN & GARDEN

JANITORIAL

AUTOMOTIVE

PAINT & SUNDRIES

INDUSTRIAL

SAFETY EQUIPMENT

TOILET REPAIR PARTS

Close Coupled Bolt Combinations :

- Brass plated, 5/16" x 3"
- For attaching tank to bowl
- Includes; 2 bolts, hex nuts, wing nuts, 4 rubber washers and 4 steel washers



Item # M92204
U/M - Pair

Closet Bolts :

- Brass plated steel
- 5/16" x 2-1/4"
- For attaching bowl to floor
- Includes; 2 bolts, nuts, washers and speed nuts



Item # M92201
U/M - Pair

Plastic Bolt Cap :

- Push on type
- Covers exposed toilet bolts



Item # M92076
U/M - Each

Aquaflush Commercial Flush Valves :

- ADA Compliant with a non-hold open and no-leak handle feature, high back pressure vacuum breaker, 1 piece hex coupling nut, adjustable tailpiece, spud coupling and flange for top spud connection
- Control stop has internal siphon-guard protection
- Sweat solder kit included
- Chrome plated



Item #	U/M	Description	Top Spud
M92241	Each	Urinal Flush Valve 1gpf	3/4"
M92243	Each	Urinal Flush Valve 1.5gpf	3/4"
M92245	Each	Closet Flush Valve 1.6gpf	1-1/2"
M92247	Each	Closet Flush Valve 3gpf	1-1/2"

400A Ballcock :

- Stops leaks and squeaks
- Fits most toilet tanks
- Saves water
- Easy to install
- Adjustable height 9"-14"
- Anti-siphon operation



Item # M92045
U/M - Each

Fill Pro Toilet Fill Valve :

- Anti syphon low profile design is below the water level for quiet operation
- Installs easily in minutes
- Fits standard two piece toilets
- Easy water level adjustment



Item # M92043
U/M - Each

Refill Tube Assembly :

- Genuine Fluidmaster repair part
- Mfg# 218



Item # M92039
U/M - Each

Replacement Seal :

- Genuine Fluidmaster repair part
- Mfg# B212



Item # M92036
U/M - Each

Ballcock Repair Kit :

- Genuine Fluidmaster repair part
- Kit includes flipper seal, refill tube, supply nut, and two seals
- Mfg# B220



Item # M92042
U/M - Each

American Standard Flush Valve :

- Replaces #3158.078
- Old #5



Item # M92249
U/M - Each

American Standard Float Assembly :

- Replaces #73380-07
- Old #5 & 6



Item # M92253
U/M - Each

American Standard Float Assembly :

- Replaces #33642-07
- #5



Item # M92256
U/M - Each



MILL SUPPLY CO., INC.

Phone (410) 485-3343
Fax (410) 325-2240

Toll Free 1-800-817-8183
Online: www.millsupplyco.com

TOILET REPAIR PARTS

Seat Disc :

- Fits all American Standard flush valves
- Easy to install



Item #	U/M	Description
M92238	Each	Screw-On
M92240	Each	Snap-On

Douglas Type Flush Valve :

- Easy to install
- Always shuts without hanging up



Item # M92261
U/M - Each

Eljer Touch Flush Assembly :

- Chrome plated handle
- Rubber float

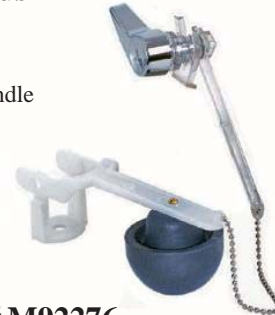

Item # M92276
U/M - Each

1B1 Ballcock Repair Kit :

- Kit includes complete piston, 1-1/4 & 1-1/2 diaphragm, rubber piston washer, seat washer, cap gasket, and screws



Item # M92021
U/M - Each

Eljer Tank Ball :

- Designed to fit the curvature of all flush valves
- Built-in flexibility insures perfect sealing



Item # M92286
U/M - Each

Toilet Tank Float Ball :

- Leakproof plastic
- 4" x 5"



Item # M92319
U/M - Each

Ballcock Float Rod :

- 8" Brass



Item # M92303
U/M - Each

Tank Ball Lift Wire :

- Fits all tank balls on the market
- Brass



Item #	U/M	Description
M92311	Each	4-1/2" Lower
M92309	Each	9" Upper



MILL SUPPLY CO., INC.

Phone (410) 485-3343
Fax (410) 325-2240

Toll Free 1-800-817-8183
Online: www.millsupplyco.com

PLUMBING

MAINTENANCE

ELECTRICAL

HARDWARE

CONSTRUCTION & BUILDING SUPPLIES

Tools

LAWN & GARDEN

JANITORIAL

AUTOMOTIVE

PAINT & SUNDRIES

INDUSTRIAL

SAFETY EQUIPMENT

TOILET REPAIR PARTS

Flush Valve Shank Washer :

- Beveled rubber
- 2-1/4" ID x 3-1/8" OD x 3/8" thick



Item # M92334
U/M - Each

Ballcock Shank Washer :

- Rubber
- 7/8" ID x 1-11/16" x 1/2" thick



Item # M90611
U/M - Each

Ballcock Lock Nut :

- 7/8" ballcock thread



Item #	U/M	Description
M92269	Each	Brass
M92270	Each	Plastic

Ballcock Coupling Nut :

- 7/8" ballcock thread



Item # M92268
U/M - Each

Flapper Lift Chain :

- 9" Stainless steel
- With hook & bullnose



Item # M92299
U/M - Each

Float Valve Chain :

- Replacement chain assembly for American Standard float valves



Item # M92306
U/M - Each

Big Ben Flapper :

- Improved design insures positive seal
- Warranted 5 years



Item # M92025
U/M - Each

3-Way Flapper :

- Removable collar
- Fits Douglas flush valves
- Fits Crane without overflow tube
- Fits new style valves with posts



Item # M92029
U/M - Each

Korky Universal Flapper :



- The original toilet flapper, the choice of Plumbing Pro's since 1954
- Universal design fits both brass and plastic flush valves
- Molded of durable rubber
- Best seller



Item # M92032
U/M - Each

Korky Plus Flapper :



- Molded of durable rubber
- Universal design fits both brass and plastic flush valves
- Flapper eliminates leaks with a water-tight seal
- Made of Chlorazone to resist chlorine and other chemicals in the water
- Will not warp, swell or deteriorate



Item # M92026
U/M - Each

Flusher Fixer Kit :



- Stops noisy tank drain leaks
- Includes flapper and seat
- Easy to install, fits most tanks
- Floating chain eliminates outdated wires/guides



Item #	U/M	Description	Mfg#
M92052	Each	Complete Kit	555C
M92049	Each	Flapper Only	B500P10



MILL SUPPLY CO., INC.

Phone (410) 485-3343
Fax (410) 325-2240

Toll Free 1-800-817-8183
Online: www.millsupplyco.com

TOILET REPAIR PARTS

Universal Tank Lever :

- Chrome finished metal handle
- Brass plated arm
- 8-1/2" length



Item #	U/M	Description
M92103	Each	Plastic Nut
M92106	Each	Brass Nut

Sure-Fit Tank Lever #681 :

- Trim / Bend to fit, no pre-measuring required
- Self-tightening lock-nut won't loosen over time
- Fits most tanks including; American Standard 4" and 6", Artesian, Crane, Eljer, Gerber, Kohler Wellworth, Mansfield, Peerless, Toto and many more
- Chrome handle

Fluidmaster



Item # M92116
U/M - Each

Short Arm Tank Lever :

- 4-1/4" length
- Fits Eljer, Briggs and American Standard
- Plastic handle & nut, chrome finished handle



Item # M92100
U/M - Each

Tank Lever for Mansfield :

- 9-1/8" length
- Blue plastic, bendable arm
- Plastic nut, chrome finished plastic handle



Item # M92097
U/M - Each

Side Mount Tank Lever :

- 9-1/4" length
- Fits Eljer
- Plastic nut, brass arm, chrome finished metal handle



Item # M92091
U/M - Each

Polished Brass Tank Lever :

- 8-1/2" length
- Brass arm
- Metal handle, polished brass finish
- Metal nut



Item # M92110
U/M - Each

Universal Tank Lever :

- 8-1/2" length
- Plastic handle, nut and arm
- Chrome finished handle



Item # M92109
U/M - Each

Tank Lever for Mansfield :

- 10-1/4" length
- Brass bent arm
- Plastic nut, chrome finished metal handle

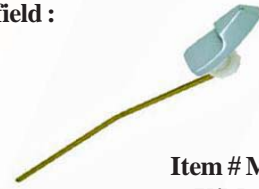

Item # M92094
U/M - Each

Drain Plunger:

- 6" Cup
- For general household use
- Includes wood handle



Item # M92481
U/M - Each

Original Korky Plunger :

- Professional strength plunger made of non-marring rubber
- Fits most toilets including 1.6
- Longer 21" yellow wood handle
- Durable and flexible for a more powerful plunge



Item # M92487
U/M - Each

Heavy Duty Plunger :

- Heavy Duty 6" Cup
- Provides high capacity force against tough toilet and drain stoppages
- Includes wood handle



Item # M92484
U/M - Each

Toilet Tank Cover :

- Replacement cover made of high impact plastic
- High tension spring adjusts cover to fit round or beveled corner tanks, wall hung or free standing
- Recess styling



Item # M92496
U/M - Each



MILL SUPPLY CO., INC.

Phone (410) 485-3343
Fax (410) 325-2240

Toll Free 1-800-817-8183
Online: www.millsupplyco.com

PLUMBING

MAINTENANCE

ELECTRICAL

HARDWARE

CONSTRUCTION & BUILDING SUPPLIES

Tools

LAWN & GARDEN

JANITORIAL

AUTOMOTIVE

PAINT & SUNDRIES

INDUSTRIAL

SAFETY EQUIPMENT

TOILETS / URINALS

Chinalux Round Front :

- #120012-1100RF Includes; Bowl (1.6 gpf) regular rim, vitreous china, low consumption, floor mounted, siphon wash, close-coupled combination with bolt caps. Tank - 12" roughing-in vitreous china tank and cover with anti-siphon ballcock and flushvalve.
- 2" Trapway
- Slotted rim flushing
- Conforms to ANSI/ASME A112.19.2M standard
- Sold as a complete set
- Color - White



Item # **M90166**
U/M - Each

Galaxy Elongated Front :

- #3792 Includes; Bowl (1.6 gpf) elongated rim, vitreous china, low consumption, floor mounted, siphon wash, close-coupled combination with bolt caps. Tank - 12" roughing-in vitreous china tank and cover with anti-siphon ballcock and flushvalve.
- 2" Trapway
- Slotted rim flushing
- Made in U.S.A.
- Conforms to ANSI/ASME A112.19.2M standard
- Sold as a complete set
- Color - White



Item # **M90167**
U/M - Each

Deluxe Radcliff Round Front :

- #3943 Includes; #3243 Bowl (1.6 gpf) regular rim, vitreous china, low consumption, floor mounted, rim fed siphon action, with self draining jets and bolt caps. #3544 Tank - 12" roughing-in vitreous china tank and cover with flushvalve, float valve with backflow preventer and chrome plated trip lever.
- 2" *Smooth sided trapway*
- Made in U.S.A.
- Conforms to ANSI/ASME A112.19.2M standard
- Sold as a complete set
- Color - White



Item # **M90170**
U/M - Each

Economiser (Pressure Assisted) Round Front :

- #3834 Includes; #3824 Bowl (1.6 gpf) regular rim, vitreous china, low consumption, floor mounted, direct-fed jet, siphon-assisted blow-out action, with bolt caps #3612 Tank - 12" roughing-in vitreous china tank containing pressurized vessel with built-in pressure regulator, backflow preventer and chrome plated trip lever
- Fully glazed trapway
- Pressure assisted flushing technology with well jet
- Made in U.S.A.
- Conforms to ANSI/ASME A112.19.2M standard
- Sold as a complete set
- Color - White



Item # **M90174**
U/M - Each

Crane ADA Elongated Front Toilet-To-Go :

- Vitreous China 2-piece
- 1.6 gallons per flush
- Meets Requirements for both ADA & ANSI117.1 when installed per code
- Elongated rim, 17" high bowl
- Siphon Vortex bowl with shelf top tank
- Fully glazed 2" trapway
- 12" rough-in
- Carton contains; tank, bowl, toilet seat, wax ring & flang bolts (less supply line)
- Color - White



Item # **M90172**
U/M - Each

Eco Richland Wall Mounted Urinal :

- #7120 Vitreous china wall hung, washout action urinal
- Requires a flushvalve with vacuum breaker, 1" angle screwdriver stop and flush connection
- Wall mounted with supplied concealed hangers and supporting bolts
- ADA compliant when mounted at 17" maximum height
- Fixture conforms to ANSI/ASME A112.19.2M
- Color - White



Item # **M90151**
U/M - Each



MILL SUPPLY CO., INC.

Phone (410) 485-3343
Fax (410) 325-2240

Toll Free 1-800-817-8183
Online: www.millsupplyco.com

TOILET SEATS

Economy Round Wood :

- Fits any standard round front fixture
- Top mount hinges provide fast, easy installation / Connected snap-on cap conceals bolt head when closed
- Color - White



Item # **M90024**
U/M - Each

Case Qty
6/ea

Round Plastic :

- Fits any standard round front fixture
- Economical, light-weight polypropylene seat
- Top mount hinges provide fast, easy installation / Connected snap-on cap conceals bolt head when closed
- Exclusive Perma-Bumper design features integrally molded bumpers that are permanent, sanitary and easy to clean
- Color - White



Item # **M90075**
U/M - Each

Case Qty
10/ea

Round Wood Standard Colors :

- Compression molded for superior strength
- Electrostatically applied multi-coat enamel finish provides uniform coverage
- Matching top mount hinges of impact resistant thermoplastic have strong, non-corrosive nylon bolts fitted with self-aligning plastic nut
- Seats meet or exceed existing housing standards
- Sold per each



Case Qty
6/ea

Elongated Open Front Wood Less Cover :

- Compression molded for superior strength
- Matching top mount hinges of impact resistant thermoplastic have strong, non-corrosive nylon bolts fitted with self-aligning plastic nuts
- Color - White



Item # **M90015**
U/M - Each

Case Qty
6/ea

Elongated Front Wood :



- Seat and covers are compression molded for superior strength
- Top mount hinges of impact resistant thermoplastic have strong, non-corrosive nylon bolts with self-aligning plastic nuts
- Four bar bumpers on each seat
- Color - White



Case Qty
6/ea

Item # **M90003**
U/M - Each

Elongated Front Wood Standard Colors :

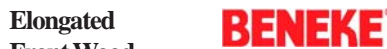

- Square back seat and contour designed cover are compression molded for superior strength
- Top mount hinges of impact resistant thermoplastic have strong, non-corrosive nylon bolts with self-aligning plastic nuts
- Four bar-type bumpers on each seat
- Sold per each



Case Qty
6/ea

Elongated Square Front Plastic - Eljer :



- Designed exclusively for Eljer Emblem elongated bowl or other square-front elongated bowls
- Injection molded of high strength, impact and chemical resistant polypropylene
- Matching semi-concealed top mount hinges
- Color - Natural



Case Qty
6/ea

Item # **M90021**
U/M - Each



MILL SUPPLY CO., INC.

Phone (410) 485-3343
Fax (410) 325-2240

Toll Free 1-800-817-8183
Online: www.millsupplyco.com

- PLUMBING
- MAINTENANCE
- ELECTRICAL
- HARDWARE
- CONSTRUCTION & BUILDING SUPPLIES
- Tools
- LAWN & GARDEN
- JANITORIAL
- AUTOMOTIVE
- PAINT & SUNDRIES
- INDUSTRIAL
- SAFETY EQUIPMENT

DRAIN CLEANING EQUIPMENT

K-3 Closet Auger :



- Fast and safe clearing of closet obstructions
- Durable, kink-resistant 1/2" compression wrapped inner core cable
- Large, ergonomically designed handle
- 3' length / Bulb head



Item # M22016
U/M - Each

6' Closet Auger :



- Fast and safe clearing of closet obstructions
- Vinyl guard protects bowls
- Large, ergonomically designed handle
- 6' length / Bulb head
- Mfg. #T6FL



Item # M92005
U/M - Each

15' Plastic Drum Auger :



- Sealed rust proof molded poly canister
- High grade, high carbon, non-kink, rust resistant spring steel with open wound boring head
- Cleans 1-1/4" to 2" lines



Item # M92004
U/M - Each

K-26 Hand Spinner :



- Slip resistant collet chuck that clasps/ unclasps cable with the flick of the wrist
- 5/16"x25' cable with bulb head auger for maximum flexibility
- Plastic drum won't rust or dent also permits access to cable to apply rust inhibitor



Item # M92002
U/M - Each

K-40GPF Drain Cleaning Machine:



Ideal for cleaning small secondary drain lines from 3/4" to 2" and when used with the back-saving Guide Tube Autofeed combination **THERE IS NO MESS!** Your hands literally never need to touch the cable. Includes; Autofeed, guide hose and mounting bracket



Item # M22082
U/M - Each

K-39-5 Drain Gun :



- Lightweight and easy to use
- Excellent for cleaning drains up to 2-1/2"
- Drums won't rust or dent - ever
- CSA approved
- Includes 25' of 5/16" cable, 35' of 3/8" cable, 2 drums, 5 piece tools set, and a metal carrying case



Item # M22081
U/M - Each

K-50 Drain Cleaning Machine :



For cleaning 3/4" through 4" lines through 100' Handles 5/8" sectional cable through 100' Quickly adapts to spin 25' of 5/16" cable or 35' of 3/8" cable. Here is a uniquely versatile machine for small to medium jobs. Easy to carry, it features famous RIDGID/Kollmann speed-cleaning through traps and bends at 400 rpm. Instant-acting clutch, with fingertip starting, stopping, reversing. 1/4 hp, 115V., 60-Hz. (available with 230V, 50 Hz motor) motor. Available in four combinations which include various selections of cables, tools and accessories. A-30 Cable Kit Complete, adapts the K-50 to clean lines from 1-1/2" through 3". A-30 includes 45' (6 lengths) of 5/8" open wind cable with Speed Coupler in steel carrier, grease "C" cutter, bulb auger, straight auger, coupling pin key and 6' guide hose.



K-1500A Drain Cleaning Machine :



- For 2" to 8" Drain and Sewer Lines.
- The finest all-around sewer and drain cleaning machine. One man can easily clean the heaviest blockages - indoors or out. High-speed cleaning gets the job done faster...better.
- Unique, easy-to-use instant acting cable clutch maximizes operator control.
- Wheels to the jobsite - sets up fast - cleans-up fast
- Equipped to run 15-foot sections of 1-1/4" cable up to 200' - 115V-60Hz / 3/4 HP Motor.
- Includes; Machine with A-1 Mitt, A-12 Pin Key, A-34-12 Rear Hose Guide, 7/ea Sections, of 1-1/4" (C-11) Cable, 2/ea A-8 Cable Carriers, and 1/ea 9 Piece 1-1/4" Tool Set.



Item # M21970
U/M - Each

Item # M21972
Model # K-50
Machine Only

Item # M21976
Model # K-50-4
Machine with:
A-30 Cable kit

Item # M21978
Model # K-50-6
Machine with:
A-17-A Adapter
A-30 Cable kit

Item # M21980
Model # K-50-8
Machine with:
A-17-A &
A-17-B Adapters
A-30 Cable kit



MILL SUPPLY CO., INC.

Phone (410) 485-3343
Fax (410) 325-2240

Toll Free 1-800-817-8183
Online: www.millsupplyco.com

RIDGID ACCESSORIES

Straight Auger : **RIDGID**

- Straight 5"
- For use in exploring and breaking up stoppages or returning sample to surface to determine correct tool
- Fits cables C-4, C-6 and C-8
- Mfg# T-201



Item # M22052
U/M - Each

Bulb Auger : **RIDGID**

- 3" Long , 1-1/8" diameter
- Used for easy cleaning of lines with a number of elbows
- Fits cables C-4, C-6 and C-8
- Mfg# T-202



Item # M22056
U/M - Each

Drop Head Auger : **RIDGID**

- 4" Long
- For cleaning back to back mounted fixtures e.g., sinks where cable needs to be led into down pipe
- Fits cables C-4, C-6 and C-8
- Mfg# T-217



Item # M22076
U/M - Each

Funnel Auger : **RIDGID**

- 3" Long
- For use as second tool in line
- Breaks up remains of stoppage left by straight auger
- Fits cables C-4, C-6 and C-8
- Mfg# T-206



Item # M22064
U/M - Each

Grease "C" Cutter : **RIDGID**

- 1-3/8"
- For grease blockage in lines leading from garbage disposal unit or waste pipe
- Fits cables C-4, C-6 and C-8
- Mfg# T-205



Item # M22060
U/M - Each

Spiral Bar Cutter : **RIDGID**

- 1-1/4"
- For main sewers blocked by roots, leaf debris, sticks, sawdust, cloth, sacking
- Fits cables C-4, C-6 and C-8
- Mfg# T-207



Item # M22068
U/M - Each

Spade Cutter : **RIDGID**

- 1" Wide
- For following up after augers have been used and to open up floor drains
- Fits cables C-4, C-6 and C-8
- Mfg# T-210



Item # M22072
U/M - Each

Four Blade Saw Tooth Cutter : **RIDGID**

- 1-3/8" Wide
- For blockages caused by hardened, glazed material such as chemical deposits
- Fits cables C-4, C-6 and C-8
- Mfg# T-214

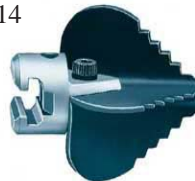

Item # M22074
U/M - Each

Operator Mitt : **RIDGID**

- Tough leather, heavily riveted for maximum strength against rotating cable



Item #	U/M	Description	Mfg#
M22004	Each	Right hand	A-2
M21984	Each	Left Hand	A-1

Pin Key : **RIDGID**

- For 5/8" cable
- Mfg# A-13



Item # M21992
U/M - Each



MILL SUPPLY CO., INC.

Phone (410) 485-3343
Fax (410) 325-2240

Toll Free 1-800-817-8183
Online: www.millsupplyco.com

- PLUMBING
- MAINTENANCE
- ELECTRICAL
- HARDWARE
- CONSTRUCTION & BUILDING SUPPLIES
- Tools
- LAWN & GARDEN
- JANITORIAL
- AUTOMOTIVE
- PAINT & SUNDRIES
- INDUSTRIAL
- SAFETY EQUIPMENT

RIDGID ACCESSORIES

C-1 Cable w/Bulb Auger : **RIDGID**

- 5/16" x 25', with bulb auger
- For drain lines 3/4" to 1-1/2"
- Ideal for kitchen sinks, lavatory sinks, bathtub drains, drinking fountains, and urinals
- For K-40, K-39-5 and K-50 machines



Item # M22020
U/M-Each

C-2/C-22 Cable w/Drop Head Auger : **RIDGID**

- 5/16" x 25'/50'
- For drain lines 3/4" to 1-1/2"
- Especially good for back-to-back mounted fixtures and severe bends
- For K-40, K39-5 and K-50 machines



Item #	U/M	Model #	Length
M22022	Each	C-2	25'
M22079	Each	C-22	50'

C-4/C-6 Cable w/Male Coupling : **RIDGID**

- 3/8" x 25'/35'
- For drain lines 1-1/4 to 2-1/2"
- Ideal for kitchen sinks, lavatory sinks, slop sinks, and disposal waste lines
- For K-40, K-39-5 and K-50 machines



Item #	U/M	Model #	Length
M22024	Each	C-4	25'
M22032	Each	C-6	35'

C-5 Cable w/Bulb Auger : **RIDGID**

- 3/8" x 35', with bulb auger
- For drain lines 1-1/4" to 2-1/2"
- Ideal for kitchen sinks, lavatory sinks, slop sinks, and disposal waste lines
- For K-40, K-39-5 and K-50 machines



Item # M22028
U/M-Each

C-7 Cable w/Tight Wind : **RIDGID**

- 5/8" x 7-1/2'
- For 2" and 3" floor drains
- Tight wind cable providing good rigidity in a hollow core cable.
- Not for tree roots
- For K-50 machine only



Item # M22036
U/M-Each

C-8 Cable w/All-Purpose Wind : **RIDGID**

- 5/8" x 7-1/2'
- For drains 1-1/4" to 2"
- Ideal for proper cleaning of small lines
- More flexible than C-7
- For K-50 machine only



Item # M22040
U/M-Each

Adapter : **RIDGID**

- **A-17-A** Adapter has 25' of 5/16" cable with bulb auger
- **A-17-B** Adapter has 35' of 3/8" cable with bulb auger



Item #	U/M	Mfg#
M21996	Each	A-17-A
M22000	Each	A-17-B

A-30 Cable Kit : **RIDGID**

- Kit includes, 6ea sections of C-8 (5/8"x7-1/2') cable, 1ea T-201, T-202, T-205, T-211 augers, 1ea A-13 Pin key, 1ea A-10 cable carrier, 1ea A-14-6 rear guide hose and 1ea A-1 left hand mitt



Item # M22008
U/M-Each

Cable Rust Inhibitor : **RIDGID**

- Superior rust preventative
- Designed exclusively for drain cleaning cables and rods
- Preserves and protects, eases effort
- Lightly scented
- 1 gallon container



Item # M22018
U/M-Each



MILL SUPPLY CO., INC.

Phone (410) 485-3343
Fax (410) 325-2240

Toll Free 1-800-817-8183
Online: www.millsupplyco.com

PUMPS / PUMP ASSY'S / PLUMBING TOOLS

Pedestal Sump Pump :

- ABS Thermoplastic base
- 1-1/2" discharge outlet
- 1/3 HP
- U.L. Listed
- High capacity 50 GPM

PERFORMANCE TABLE (in gallons per minute)

VERTICAL PUMPING DISTANCE IN FEET						
6'	8'	10'	12'	14'	16'	18'
50	45	39	32	23	13	2



Item # M97552
U/M - Each

1/3 HP Submersible Sump Pump :

- Sturdy thermoplastic housing
- Pumps up to 2,400 GPH
- Top suction filters debris
- High capacity 1-1/4" discharge



Item # M97554
U/M - Each

Drill Pump :

- Sturdy thermoplastic housing
- Works with electric drills (minimum drill speed 1200 RPM)
- Compact design pumps up to 225 gallons per hour
- Perfect for emptying dishwashers, washing machines, clogged sinks, etc.
- For use with 5/8" garden hose



Item # M97551
U/M - Each

Sump Pump Discharge Kit :

- For use with all types of sump pumps to discharge water outside of the basement at a safe distance from the house
- Kits includes; 1-1/4" corrugated 24' hose, 1-1/4" male adapter and a steel hose clamp



Item # M97576
U/M - Each

Sump Pump Check Valve :

- Prevent backflow of water
- Made of durable vinyl material
- 1-1/4" Male pipe thread



Item # M97578
U/M - Each

Faucet Handle Puller :

- Hardened steel faucet handle puller
- Removes all hooded type and all cross and lever handles easily and quickly



Item # M99025
U/M - Each

Moen Cartridge Puller :

- For Moen stems and Moen cartridges from faucets and shower valves



Item # M99057
U/M - Each

Basin Wrench :

- Made of drop forged steel with hardened teeth
- May be opened either to the right or to the left
- Spring loaded jaws
- 11" Long



Item # M99008
U/M - Each

Adjustable Basin Wrench :

- Adjustable 9"-15"
- Forged alloy steel jaws, hardened jaws
- Spring loaded jaws



Item # M99015
U/M - Each

Plastic Nut Basin Wrench : **RIDGID**

- Designed to reach and turn plastic mounting nuts on faucets, sprayers and ballcocks
- Making installing faucets quick and easy
- 11" overall length allows user to get behind sinks and garbage disposals with ease



Item # M99014
U/M - Each

4 Way Key Wrench :

- For valve faucets, sill cocks
- 1/4", 9/32", 5/16", 11/32" square stems



Item # M99031
U/M - Each



MILL SUPPLY CO., INC.

Phone (410) 485-3343
Fax (410) 325-2240

Toll Free 1-800-817-8183
Online: www.millsupplyco.com

PLUMBING

MAINTENANCE

ELECTRICAL

HARDWARE

CONSTRUCTION & BUILDING SUPPLIES

Tools

LAWN & GARDEN

JANITORIAL

AUTOMOTIVE

PAINT & SUNDRIES

INDUSTRIAL

SAFETY EQUIPMENT

PLUMBING TOOLS

Strainer Lock Nut Wrench :

- Chrome finish
- For removing strainer lock nuts
- Hardened steel



Item # M99009
U/M - Each

All-Purpose Wrench :

- Fits spuds, slip nut, lock nuts
- Adjusts to 3"



Item # M99026
U/M - Each

Strainer Wrench :

- For installation of bath tub drain and kitchen sink basket strainers
- Chrome plated



Item # M99010
U/M - Each

Angle Seat Wrenches :

- 6" x 6" hardened steel
- 3 Hex sizes on one end, and 3 square on the other



Item #	U/M	Description
M99022	Each	Stepped Ends
M99019	Each	Tapered Ends

Socket Wrench Set :

- 7 Piece set
- Permits easy access to recessed valve stem
- Eliminates chipped tile around valve stem opening



Item # M99035
U/M - Each

Water Heater Element Removal Tool :

- Reaches into offsets
- Works with any screwdriver



Item # M99006
U/M - Each

4-Piece Seat Wrench Set :

- For easy removable and installation of faucet seats
- Includes ratchet wrench
- 4pc. set



Item # M99016
U/M - Each

Acid Brush :

- 6" long
- 1/2" wide
- Filled with horse hair



Item # M92804
U/M - Each

Fitting Brushes :

- Plastic handle and high carbon crimped steel brush
- Ideal for plumbing and refrigeration applications



Item #	U/M	Size
M92809	Each	1/2"
M92812	Each	3/4"
M92815	Each	1"
M92818	Each	1-1/4"



MILL SUPPLY CO., INC.

Phone (410) 485-3343
Fax (410) 325-2240

Toll Free 1-800-817-8183
Online: www.millsupplyco.com

BRAZING / SOLDERING SUPPLIES

Propane Cylinder :

- For basic use torches and most portable appliances requiring propane
- 14.1oz.
- Disposable



Item # M24318
U/M - Each

Mapp Gas Cylinder :

- Use only with multi-application torches and appliances specifying "for use with Mapp gas or propylene."
- 16oz.
- Burns hotter than propane
- Disposable



Item # M24319
U/M - Each

Pencil Flame Torch Head :

- Better quality, all brass torch
- 3X heat output of utility torches
- Produces a 1-1/4" flame for heavy duty soldering and heating jobs



Item # M24276
U/M - Each

Trigger Start Propane Torch Kit :

- Includes a 14.1oz. propane cylinder and a trigger start head



Item # M24270
U/M - Each

Butane Lighter :

- Perfect for year-round use
- A must for barbecues, candles and fireplaces
- Convenient long black metal wand
- Pre-adjusted flame
- Two-step ignition
- Child-resistant mechanism
- Visible fuel supply window
- Retractable hook for handy storage



Item # M24316
U/M - Each

Wire Solder :

- Most commonly used where frequent and extreme temperature changes and vibration occur
- Meets the requirement of the Safe Water Drinking Act
- 93 /7 melts, flows and performs better than 95 /5 solder



Item #	U/M	Gauge	Size	Type
M99990	Each	0.081"	1/4lb.	95/5
M99991	Each	0.117"	1lb.	93/7



MILL SUPPLY CO., INC.

Phone (410) 485-3343
Fax (410) 325-2240

Toll Free 1-800-817-8183
Online: www.millsupplyco.com

PLUMBING

MAINTENANCE

ELECTRICAL

HARDWARE

CONSTRUCTION & BUILDING SUPPLIES

Tools

LAWN & GARDEN

JANITORIAL

AUTOMOTIVE

PAINT & SUNDRIES

INDUSTRIAL

SAFETY EQUIPMENT

PIPE REPAIR PRODUCTS

Plumbers Grease :

- Makes hard turning faucets work smoothly
- Lubricates stems of faucets, valves, ballcocks, plungers, packings and washers
- Use on hot water or steam to 350 degrees F.
- Waterproof
- 1oz. container



Item # M99988
U/M - Each

Pipe Joint Compound :

- A soft set, non-hardening, smooth, grit-free, gray colored pipe joint for all types of metal connections



Item #	U/M	Size / Type
M99957	Each	1oz. squeeze tube
M99958	Each	8oz. can

Multi-Purpose Cement :

- Medium bodied, medium set cement designed for use on PVC, CPVC and ABS pipe and fittings Schedule 40 & 80 types I and II up to 6'
- For potable water, pressure pipe, gas, conduit, drain waste and vent pipe
- Apply between 40 and 100 degrees F.



Item #	U/M	Size
M99962	Each	4oz.
M99964	Each	8oz.
M99968	Each	Pint

PVC Cement : **Oatey**

- Regular-bonded clear cement recommended for use on PVC fittings up to 4" for SCH. 40 and up to 2" for SCH. 80
- For potable water pressure pipe, gas, conduit, drain waste and vent pipe
- Flows easily and sets up quickly
- Apply between 40 and 100 degrees F.
- NSF and UPC listed, exceeds ASTM D-2564
- 16oz. container



Item # M99959
U/M - Each

Plastic Pipe Cleaner :

- Cleans plastic pipe prior to cementing
- Includes plastic brush
- 8oz.



Item # M99972
U/M - Each

Soldering Paste Flux :

- For use on all metals except aluminum
- Cleans as it fluxes to assure complete bonding of solder and metal



Item #	U/M	Size
M99996	Each	1.7oz.
M99999	Each	4oz.

Epoxy Putty : **Oatey**

- Hardens like steel in 20 minutes
- Plugs, seals, mends and patches practically anything
- Can be used under water
- 4 oz. stick



Item # M99971
U/M - Each

Plumbers Putty :

- For setting closet bowls, sink strainers, etc.
- Has excellent adhesive qualities



Item #	U/M	Size
M99952	Each	14oz.
M99954	Each	5lb.

Thrift :

- For drains, grease traps, septic systems and root control
- Odorless
- Will not harm plumbing or septic systems



Item # M66080
U/M - Each

Liquid Drain Opener :

- Concentrated, 97% sulfuric acid drain opener
- Dissolves hair, cotton, paper and most organic matter, and some inorganic matter that may cause drain clogging
- Includes protective gloves and apron
- For professional use only
- 1 quart



Item # M66081
U/M - Each

Drano Liquid Drain Opener :

- Opens drains quickly by attacking tough grease-based clogs, even through standing water
- Will not harm septic tanks or cesspools
- 32oz. bottle



Item # M66083
U/M - Each



MILL SUPPLY CO., INC.

Phone (410) 485-3343
Fax (410) 325-2240

Toll Free 1-800-817-8183
Online: www.millsupplyco.com

VALVES / COPPER PIPE / CLAMPS / THERMOCOUPERS

Stop & Waste Valves :

- Brass body, cast iron handles



Threaded
(IPS)



Solder
(Sweat)



Compression

Item #	U/M	Description	Size
M99671	Each	Threaded ends	1/2"
M99672	Each	Threaded ends	3/4"
M99676	Each	Solder ends	1/2"
M99677	Each	Solder ends	3/4"
M99667	Each	Comp x Comp	1/2"
M99668	Each	Comp x Comp	3/4"

Gate Valves :

- Brass body, cast iron handles
- Designed for use in a fully opened or closed position



Item #	U/M	Description	Size
M99544	Each	Threaded ends	1/2"
M99545	Each	Threaded ends	3/4"
M99556	Each	Solder ends	1/2"
M99557	Each	Solder ends	3/4"
M99558	Each	Solder ends	1"
M99661	Each	Solder ends	2"

Ball Valves :

- 400 PSI (Water, oil, or gas)
- Chrome plated solid brass ball
- Quarter turn operation
- Brass body
- Teflon seats



Item #	U/M	Description	Size
M99505	Each	Threaded ends	1/2"
M99506	Each	Threaded ends	3/4"
M99522	Each	Sweat ends	1/2"
M99523	Each	Sweat ends	3/4"
M99524	Each	Sweat ends	1"

Ice Maker Installation Kit :

- Kit includes: self tapping valve, tubing and all necessary brass fittings



Item #	Tubing Type
M99768	25' polyethylene
M99772	15' Copper

Hard Copper Water Tubing :

- For plumbing, heating, and industrial use
- 10 ft. lengths



Item #	U/M	Type	Size
M99155	Each	"M"	1/2"
M99157	Each	"M"	3/4"
M99179	Each	"L"	1/2"
M99180	Each	"L"	3/4"

Soft Copper Water Tubing :

- Refrigeration tubing is for use in air conditioning, ice makers, humidifiers and refrigeration systems (sold in 50' coils).
- M99140 is 1/4" (3/8" NOM) x 60' for use in commercial plumbing and heating applications



Item #	U/M	Type	Size
M99130	Each	"REF"	1/4" OD
M99133	Each	"REF"	3/8" OD
M99134	Each	"REF"	1/2" OD
M99135	Each	"REF"	5/8" OD
M99136	Each	"REF"	3/4" OD
M99140	Each	"L"	3/8" NOM

Ice Maker Supply Lines :

- 1/4" compression x 1/4" compression connection
- Stainless steel braided for superior strength
- M99781 is a Fluidmaster OEM (No-Burst) Supply Line



Item #	U/M	Length
M99776	Each	5'
M99781	Each	10'

Pipe Repair Clamps :

- With rubber gaskets, 2 bolts and 2 nuts
- Galvanized



Item #	U/M	Size
M98909	Each	1/2"
M98913	Each	3/4"
M98915	Each	1"
M98921	Each	1-1/4"
M98923	Each	1-1/2"

Hanger Straps :

- Incorporates a special design which allows for pipe expansion
- Can be used on copper



Item #	U/M	Size
M95995	Each	1/2"
M95996	Each	3/4"

Thermocouplers :

- For use in gas water heaters, gas furnaces, gas space heaters and gas logs
- Replaces most common thermocouplers



Item #	U/M	Size
M93406	Each	18"
M93412	Each	24"
M93418	Each	36"
M93424	Each	48"



MILL SUPPLY CO., INC.

Phone (410) 485-3343
Fax (410) 325-2240

Toll Free 1-800-817-8183
Online: www.millsupplyco.com

PLUMBING

MAINTENANCE

ELECTRICAL

HARDWARE

CONSTRUCTION & BUILDING SUPPLIES

Tools

LAWN & GARDEN

JANITORIAL

AUTOMOTIVE

PAINT & SUNDRIES

INDUSTRIAL

SAFETY EQUIPMENT

WATER HEATERS - ELECTRIC

Lowboy Electric Water Heater :



- Resistor design heating elements prolong anode rod and tank life
- Furnished with standard 240v AC, single phase, non-simultaneous wiring
- 4,500 watt upper and lower element for faster recovery
- T & P valve installed
- Non-CFC foam insulated
- .093 energy factor (30gal)
- .092 energy factor (38gal)
- Meets or exceeds National Appliance Energy Conservation act (NAECA) requirements
- 6 year warranty



Item #	U/M	Size	Capacity
M72057	Each	30"H x 22-1/4"	30 gallon
M72083	Each	31-1/2"H x 23"	38 gallon

Medium Electric Water Heater :



- Resistor design heating elements prolong anode rod and tank life
- Furnished with standard 240v AC, single phase, non-simultaneous wiring
- 4,500 watt upper and lower element for faster recovery
- T & P valve installed
- Non-CFC foam insulated
- .093 energy factor (30gal)
- .092 energy factor (40gal)
- .090 energy factor (50gal)
- Meets or exceeds (NAECA) requirements
- 6 year warranty



Item #	U/M	Size	Capacity
M72066	Each	36"H x 19-3/4"	30 gallon
M72088	Each	46-1/2"H x 19-3/4"	40 gallon
M72103	Each	46"H x 26-3/4"	50 gallon

Tall Electric Water Heater :



- Resistor design heating elements prolong anode rod and tank life
- Furnished with standard 240v AC, single phase, non-simultaneous wiring
- 4,500 watt upper and lower element for faster recovery
- T & P valve installed
- Non-CFC foam insulated
- .093 energy factor (30gal)
- .092 energy factor (40gal)
- .090 energy factor (50gal)
- Meets or exceeds National Appliance Energy Conservation act (NAECA) requirements
- 6 year warranty



Item #	U/M	Size	Capacity
M72072	Each	45-3/4"H x 17-3/4"	30 gallon
M72094	Each	59-1/4"H x 17-3/4"	40 gallon
M72108	Each	57"H x 19"	50 gallon

No-Burst Water Heater Connectors :



- Made of braided stainless steel
- High bursting strength with stainless ferrules that are extra long with double radial crimps for more security
- Tough, TPR core resists chlorine and chloramines
- Captive flap washers seal tightly
- Exceptional flexibility for fast, easy installation. Won't kink or crease, even in the tightest of spaces
- Heavy-duty brass nuts are easy to grip and nickel plated for durability
- 3/4" FIP x 3/4" FIP



Item #	U/M	Length
M99351	Each	12"
M99357	Each	18"
M99363	Each	24"



MILL SUPPLY CO., INC.

Phone (410) 485-3343
Fax (410) 325-2240

Toll Free 1-800-817-8183
Online: www.millsupplyco.com

WATER HEATERS - NATURAL GAS

Natural Gas 29gal Water Heater :

- High BTU input for fast recovery
- Durable aluminized steel burner
- Piezo ignition system for "no match" lighting
- Extra durable brass drain valve
- Rigid foam insulation for superior heat retention
- T & P valve installed
- .062 energy factor
- Meets or exceeds National Appliance Energy Conservation act (NAECA) requirements
- Tall (59-3/4" vent height / 3" vent) (56-3/8" tank height)
- 16-1/8" diameter tank
- 6 year warranty



Item # M72009
U/M - Each

Natural Gas 40gal Medium Water Heater :

- High BTU input for fast recovery
- Durable aluminized steel burner
- Piezo ignition system for "no match" lighting
- Extra durable brass drain valve
- Rigid foam insulation for superior heat retention
- T & P valve installed
- .059 energy factor
- Meets or exceeds National Appliance Energy Conservation act (NAECA) requirements
- Medium (52-1/2" vent height / 3" vent) (49-1/4" tank height)
- 20-1/8" diameter tank
- 6 year warranty



Item # M72016
U/M - Each

Natural Gas 40gal Tall Water Heater :

- High BTU input for fast recovery
- Durable aluminized steel burner
- Piezo ignition system for "no match" lighting
- Extra durable brass drain valve
- Rigid foam insulation for superior heat retention
- T & P valve installed
- .059 energy factor
- Meets or exceeds National Appliance Energy Conservation act (NAECA) requirements
- Medium (61-1/2" vent height / 3" vent) (58" tank height)
- 17-3/4" diameter tank
- 6 year warranty



Item # M72020
U/M - Each

Natural Gas 50gal Tall Water Heater :

- High BTU input for fast recovery
- Durable aluminized steel burner
- Piezo ignition system for "no match" lighting
- Extra durable brass drain valve
- Rigid foam insulation for superior heat retention
- T & P valve installed
- .058 energy factor
- Meets or exceeds National Appliance Energy Conservation act (NAECA) requirements
- Medium (61-1/2" vent height / 3" vent) (58-1/4" tank height)
- 20-1/8" diameter tank
- 6 year warranty



Item # M72029
U/M - Each



MILL SUPPLY CO., INC.

Phone (410) 485-3343
Fax (410) 325-2240

Toll Free 1-800-817-8183
Online: www.millsupplyco.com

PLUMBING

MAINTENANCE

ELECTRICAL

HARDWARE

CONSTRUCTION & BUILDING SUPPLIES

Tools

LAWN & GARDEN

JANITORIAL

AUTOMOTIVE

PAINT & SUNDRIES

INDUSTRIAL

SAFETY EQUIPMENT

PVC SCHEDULE 40 / CPVC / FITTINGS & PIPE

PVC Coupling :

- Slip x Slip
- Sold by the each



Item #	U/M	Size
M93652	Each	1/2"
M93653	Each	3/4"
M93654	Each	1"
M93655	Each	1-1/4"
M93656	Each	1-1/2"
M93657	Each	2"

CPVC Coupling :

- Slip x Slip
- Sold by the each



Item #	U/M	Size
M93615	Each	1/2"
M93616	Each	3/4"

PVC Female Adapter :

- Slip x FPT
- Sold by the each

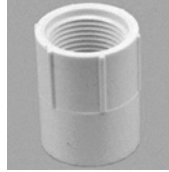

Item #	U/M	Size
M93659	Each	1/2"
M93660	Each	3/4"
M93661	Each	1"
M93662	Each	1-1/4"
M93663	Each	1-1/2"
M93664	Each	2"

CPVC Female Adapter :

- Slip x FPT
- Sold by the each



Item #	U/M	Size
M93608	Each	1/2"
M93609	Each	3/4"

PVC Male Adapter :

- Slip x MPT
- Sold by the each



Item #	U/M	Size
M93666	Each	1/2"
M93667	Each	3/4"
M93668	Each	1"
M93669	Each	1-1/4"
M93670	Each	1-1/2"
M93671	Each	2"

CPVC Male Adapter :

- Slip x MPT
- Sold by the each



Item #	U/M	Size
M93601	Each	1/2"
M93602	Each	3/4"

PVC 45 Degree Elbow :

- Slip x Slip
- Sold by the each



Item #	U/M	Size
M93673	Each	1/2"
M93674	Each	3/4"
M93675	Each	1"
M93676	Each	1-1/4"
M93677	Each	1-1/2"
M93678	Each	2"

CPVC 45 Degree Elbow :

- Slip x Slip
- Sold by the each



Item #	U/M	Size
M93642	Each	1/2"
M93643	Each	3/4"

PVC 90 Degree Elbow :

- Slip x Slip
- Sold by the each



Item #	U/M	Size
M93680	Each	1/2"
M93681	Each	3/4"
M93682	Each	1"
M93683	Each	1-1/4"
M93684	Each	1-1/2"
M93685	Each	2"

CPVC 90 Degree Elbow :

- Slip x Slip
- Sold by the each



Item #	U/M	Size
M93629	Each	1/2"
M93630	Each	3/4"

PVC Tee :

- Slip
- Sold by the each



Item #	U/M	Size
M93687	Each	1/2"
M93688	Each	3/4"
M93689	Each	1"
M93690	Each	1-1/4"
M93691	Each	1-1/2"
M93692	Each	2"

CPVC Tee :

- Slip
- Sold by the each



Item #	U/M	Size
M93636	Each	1/2"
M93637	Each	3/4"

PVC Tubing :

- 10 foot lengths
- Sold by the each



Item #	U/M	Size
M99103	Each	1/2"
M99105	Each	3/4"
M99107	Each	1"
M99109	Each	1-1/4"
M99111	Each	1-1/2"
M99115	Each	2"

CPVC Tubing :

- 10 foot lengths
- Sold by the each



Item #	U/M	Size
M99123	Each	1/2"
M99124	Each	3/4"

PVC Cap :

- Slip
- Sold by the each



Item #	U/M	Size
M93644	Each	1/2"
M93645	Each	3/4"
M93646	Each	1"
M93647	Each	1-1/4"
M93648	Each	1-1/2"
M93649	Each	2"

CPVC Cap :

- Slip
- Sold by the each



Item #	U/M	Size
M93622	Each	1/2"
M93623	Each	3/4"

PVC is for use in cold water applications only. CPVC is for use in both Hot & Cold water applications.



MILL SUPPLY CO., INC.

Phone (410) 485-3343
Fax (410) 325-2240

Toll Free 1-800-817-8183
Online: www.millsupplyco.com

PVC FLEXIBLE TUBULAR

1-1/2" Flexible "J" Bend :

- 1-1/2" x 1-1/2" or 1-1/2" x 1-1/4"
- Includes reducing washer

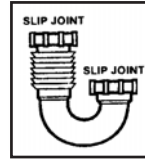

Item # M93697
U/M - Each

1-1/2" Flexible Kitchen Sink Trap :

- 1-1/2" x 1-1/2" or 1-1/2" x 1-1/4"
- Includes reducing washer

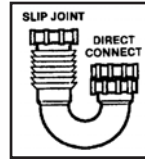

Item # M93698
U/M - Each

1-1/2" Flexible Coupling :

- Can be used as an elbow
- 1-1/2" x 1-1/2" or 1-1/2" x 1-1/4"
- Includes reducing washer

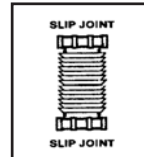

Item # M93699
U/M - Each

1-1/2" Flexible Tailpiece :

- Flanged, with captive nut
- Connects directly to strainer
- 1-1/2" x 12"

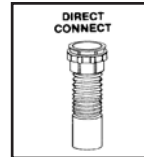

Item # M93700
U/M - Each

1-1/2" Flexible Extension Tube :

- With slip joint nut and washer
- 1-1/2" x 12"



Item # M93702
U/M - Each

1-1/4" Flexible Extension Tube :

- With slip joint nut and washer
- 1-1/4" x 8"



Item # M93701
U/M - Each

Slip Joint Nut :

- Can be attached without tools

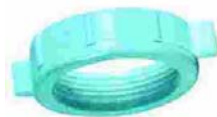

Item #	U/M	Size
M93711	Each	1-1/4"
M93712	Each	1-1/2"



MILL SUPPLY CO., INC.

Phone (410) 485-3343
Fax (410) 325-2240

Toll Free 1-800-817-8183
Online: www.millsupplyco.com

PLUMBING

MAINTENANCE

ELECTRICAL

HARDWARE

CONSTRUCTION & BUILDING SUPPLIES

Tools

LAWN & GARDEN

JANITORIAL

AUTOMOTIVE

PAINT & SUNDRIES

INDUSTRIAL

SAFETY EQUIPMENT

PVC / PLASTIC TRAPS & FITTINGS

PVCP-Trap :

- DWV PVC
- All hub



Item #	U/M	Size
M93721	Each	1-1/2"
M93724	Each	2"

PVCP-Trap LA Pattern :

- DWV PVC
- SJ x H
- Furnished with both size SJ washers
- 1-1/4" x 1-1/2" or 1-1/2" x 1-1/2"



Item # M93723
U/M - Each

PVCP-Trap w/Union Joint :

- DWV PVC
- All hub
- 1-1/2"



Item # M93722
U/M - Each

PVC 45 Degree Wye :

- DWV PVC
- All hub



Item #	U/M	Size
M93732	Each	1-1/2"
M93733	Each	2"

PVC Trap Adapters :

- DWV PVC
- Slip side comes with 1-1/2" regular washer, and PVC slip nut
- Adapts tubular to PVC/DWV
- 1-1/2"
- (A) Hub x Slip
- (B) Spigot x Slip



(A)



(B)

Item #	U/M	Type
M93751	Each	(A) Female
M93754	Each	(B) Male

Plastic P-Trap :

- For kitchen or lavatory drain
- 1-1/2" trap includes 1-1/2" to 1-1/4" reducing washer



Item #	U/M	Size
M93770	Each	1-1/4"
M93771	Each	1-1/2"

Plastic J-Bend :

- 1-1/2"
- Includes 1-1/2" to 1-1/4" reducing washer



Item # M93776
U/M - Each

Plastic Extension Tube :

- Includes slip joint nut and reducing washer
- 1-1/2" x 8"



Item # M93760
U/M - Each

Plastic Tailpiece :

- 12" is flanged on one end
- 16" is flanged on both ends



Item #	U/M	Size
M93765	Each	1-1/2" x 12"
M93766	Each	1-1/2" x 16"



MILL SUPPLY CO., INC.

Phone (410) 485-3343
Fax (410) 325-2240

Toll Free 1-800-817-8183
Online: www.millsupplyco.com

WROUGHT COPPER FITTINGS

PLUMBING

MAINTENANCE

ELECTRICAL

HARDWARE

CONSTRUCTION & BUILDING SUPPLIES

Tools

LAWN & GARDEN

JANITORIAL

AUTOMOTIVE

PAINT & SUNDRIES

INDUSTRIAL

SAFETY EQUIPMENT

Coupling :

- With stop
- Copper to Copper



Item #	U/M	Size
M95901	Each	1/4"
M95902	Each	3/8"
M95903	Each	1/2"
M95904	Each	3/4"
M95905	Each	1"
M95906	Each	1-1/4"
M95907	Each	1-1/2"

Female Adapter :

- Copper to Female N.P.T.



Item #	U/M	Size
M95925	Each	1/2"
M95926	Each	3/4"
M95927	Each	1"
M95928	Each	1-1/4"
M95929	Each	1-1/2"

Male Adapter :

- Copper to Male N.P.T.



Item #	U/M	Size
M95934	Each	1/4"
M95935	Each	3/8"
M95936	Each	1/2"
M95937	Each	3/4"
M95938	Each	1"
M95939	Each	1-1/4"
M95940	Each	1-1/2"

Cap :

- For Tube End



Item #	U/M	Size
M95984	Each	1/4"
M95985	Each	3/8"
M95986	Each	1/2"
M95987	Each	3/4"
M95988	Each	1"
M95989	Each	1-1/4"
M95990	Each	1-1/2"

90 Degree Elbow :

- Copper to Copper



Item #	U/M	Size
M95955	Each	1/4"
M95956	Each	3/8"
M95957	Each	1/2"
M95958	Each	3/4"
M95959	Each	1"
M95960	Each	1-1/4"
M95961	Each	1-1/2"

45 Degree Elbow :

- Copper to Copper



Item #	U/M	Size
M95945	Each	3/8"
M95946	Each	1/2"
M95947	Each	3/4"
M95948	Each	1"
M95949	Each	1-1/4"
M95950	Each	1-1/2"

Tee :

- Copper to Copper to Copper



Item #	U/M	Size
M95974	Each	3/8"
M95975	Each	1/2"
M95976	Each	3/4"
M95977	Each	1"
M95978	Each	1-1/4"
M95979	Each	1-1/2"

Reducing Coupling :

- Copper to Copper



Item #	U/M	Size (AxB)
M95916	Each	3/8" x 1/4"
M95917	Each	1/2" x 3/8"
M95918	Each	3/4" x 1/2"
M95919	Each	1" x 3/4"
M95920	Each	1-1/4" x 1"

45 Degree Street Elbow :

- Fitting to Copper



Item #	U/M	Size
M95952	Each	1/2"
M95954	Each	3/4"

90 Degree Street Elbow :

- Fitting to Copper



Item #	U/M	Size
M95963	Each	1/2"
M95964	Each	3/4"

Reducing Female Adapter :

- Copper to Female N.P.T.



Item #	U/M	Size (AxB)
M95931	Each	3/8" x 1/2"
M95932	Each	3/4" x 1/2"

Reducing Male Adapter :

- Copper to Male N.P.T.



Item #	U/M	Size (AxB)
M95941	Each	3/8" x 1/2"
M95942	Each	1/2" x 3/4"

All Sizes Are Nominal

All Sizes Are Nominal



MILL SUPPLY CO., INC.

Phone (410) 485-3343
Fax (410) 325-2240

Toll Free 1-800-817-8183
Online: www.millsupplyco.com

- PLUMBING
- MAINTENANCE
- ELECTRICAL
- HARDWARE
- CONSTRUCTION & BUILDING SUPPLIES
- Tools
- LAWN & GARDEN
- JANITORIAL
- AUTOMOTIVE
- PAINT & SUNDRIES
- INDUSTRIAL
- SAFETY EQUIPMENT

BLACK MALLEABLE FITTINGS

Floor & Ceiling Plates :

- Chrome finish
- Sold by the each



Item #	U/M	Fits
M92570	Each	1/2" Copper Tube
M92571	Each	3/4" Copper Tube
M92576	Each	1/2" Iron Pipe
M92579	Each	1" Iron Pipe

Pipe Nipples :

- Black steel
- Sold by the each



Item #	U/M	Size
M95392	Each	1/2" x CLS
M95393	Each	1/2" x 1-1/2"
M95394	Each	1/2" x 2"
M95395	Each	1/2" x 2-1/2"
M95396	Each	1/2" x 3"
M95397	Each	1/2" x 3-1/2"
M95398	Each	1/2" x 4"
M95399	Each	1/2" x 4-1/2"
M95400	Each	1/2" x 5"
M95402	Each	1/2" x 6"
M95406	Each	1/2" x 8"
M95410	Each	1/2" x 12"
M95411	Each	3/4" x CLS
M95412	Each	3/4" x 1-1/2"
M95413	Each	3/4" x 2"
M95414	Each	3/4" x 2-1/2"
M95415	Each	3/4" x 3"
M95417	Each	3/4" x 4"
M95421	Each	3/4" x 6"

Malleable Plug :

- Black iron
- Sold by the each



Item #	U/M	Size
M95470	Each	1/2"
M95471	Each	3/4"

90 Degree Banded Elbow :

- Black iron
- Sold by the each



Item #	U/M	Size
M95428	Each	1/2"
M95429	Each	3/4"

45 Degree Banded Elbow :

- Black iron
- Sold by the each



Item #	U/M	Size
M95434	Each	1/2"
M95435	Each	3/4"

90 Degree Street Elbow :

- Black iron
- Sold by the each



Item #	U/M	Size
M95431	Each	1/2"
M95432	Each	3/4"

Banded Tee :

- Black iron
- Sold by the each



Item #	U/M	Size
M95439	Each	1/2"
M95440	Each	3/4"

Banded Coupling :

- Black iron
- Sold by the each



Item #	U/M	Size
M95453	Each	1/2"
M95454	Each	3/4"

Union :

- Black iron
- Sold by the each



Item #	U/M	Size
M95448	Each	1/2"
M95449	Each	3/4"



MILL SUPPLY CO., INC.

Phone (410) 485-3343
Fax (410) 325-2240

Toll Free 1-800-817-8183
Online: www.millsupplyco.com