



Mill Supply Company Inc.

Full Line Catalog



Industrial Supplies



Safety Equipment



Tools



Builders Hardware



Construction & Building Supplies



Lawn & Garden



Janitorial



Paint & Sundries



Maintenance Supplies



Electrical



Plumbing

2002

Volume I • Edition I

THE BIRTH OF A NEW ERA

THE WAIT IS FINALLY OVER. IT IS WITH GREAT PRIDE AND ENTHUSIASM THAT WE PRESENT TO YOU OUR **FIRST** COMPREHENSIVE CATALOG. MY GRANDFATHER WOULD BE PLEASED TO SEE JUST HOW FAR THE FAMILY BUSINESS HE STARTED IN 1920 HAS COME. ALTHOUGH WE ARE NOW IN OUR 82nd YEAR OF OPERATION, THIS PUBLICATION SIGNIFIES A NEW ERA.

NO LONGER WILL OUR CUSTOMERS SAY "I DIDN'T KNOW YOU CARRIED THAT". WE HAVE MADE A CONCERTED EFFORT TO MAKE OUR CATALOG **USER FRIENDLY**. THERE IS AN ABUNDANCE OF TECHNICAL DATA TO MAKE ORDERING EASIER AND MORE PRECISE. ONE OF OUR GOALS IS TO FILL THE GAP OF UNCERTAINTY AND MAKE YOU FEEL CONFIDENT THAT YOUR ORDER WILL BE FILLED CORRECTLY EACH AND EVERY TIME.

OUR STAFF HAS REDEDICATED THEMSELVES TO MAINTAINING YOUR PRESENT BUSINESS AND EXPANDING IT EVEN FURTHER. AS OUR VALUED CUSTOMER, YOU WILL NEVER BE A NUMBER. WE WANT TO KNOW YOU PERSONALLY, KNOW MORE ABOUT YOUR BUSINESS, AND BETTER UNDERSTAND YOUR NEEDS SO WE CAN PROVIDE A HIGHER LEVEL OF **SERVICE**.

WE KNOW YOU HAVE OTHER OPTIONS AND WE INTEND TO SHOW YOU THAT PERSONALIZED SERVICE DOES MAKE A DIFFERENCE. WE CONTINUE TO SERVE THREE VERY DISTINCT MARKETS: INDUSTRIAL BUSINESSES, PROPERTY MANAGEMENT COMPANIES AND RESIDENTIAL AND COMMERCIAL DEVELOPERS. ALTHOUGH THERE IS SOME OVERLAP IN THE PRODUCTS THEY USE, THEY ARE EACH VERY DIFFERENT.

WE URGE YOU TO UTILIZE THE EXPERTISE OUR STAFF HAS TO OFFER, FROM PRODUCT APPLICATION TO PRODUCT SEARCH TO PRODUCT ALTERNATIVES. ITS ALL PART OF THE PACKAGE WE PROVIDE.

WE ARE SINCERELY GRATEFUL TO THOSE BUSINESSES WHO HAVE SUPPORTED US SINCE 1920 AND TO THOSE OF YOU WHO ARE JUST LEARNING ABOUT OUR VALUE. WE THANK YOU FOR THE OPPORTUNITY TO SHOW YOU THAT OUR COMPANY CAN MAKE A DIFFERENCE.

RANDY L. SAFIER
PRESIDENT

STANLEY D. SAFIER
(FORMER) PRESIDENT

JOSEPH SAFIER
FOUNDER

Mill Supply Company was established in 1920 as a retail hardware store in historic Fells Point. We have evolved into a wholesale distributor for residential builders, as well as the property management and industrial trades. We currently inventory over 9,000 items and have access to countless others.



Our knowledgeable sales staff can answer many questions quickly and accurately, ensuring that you get the correct information the first time.

We can provide you with monthly and yearly reports that will “evaluate” your purchases by category. This will allow you to see where your dollars are being spent and to help you budget accordingly.

Our current future projects include :

- Our 2nd edition of our Mill Supply Catalog.
- A PDF version of our Mill Supply Catalog on CD ROM
- E-Mail capability with anyone in our organization
- Our new web site* : **www.millsupplyco.com** (Available early 2003)

***Advantages include:**

The ability for you to place, price and check status of open orders.
The ability for you to be able to retrieve past invoices, print and view them.
The ability to check availability and pricing of any item in our catalog.
The ability to view your account balance.
The ability for you to order any of the countless items that have accessible.
Electronic conformation of orders.
The ability to get past sales reporting by location or account name, detailed by product class or specific items.



We are constantly striving to make your business our top priority. If you are a current customer, we thank you for your continued support. If you are a new customer, we want to welcome you to our Mill Supply family.



Standard Delivery Zone

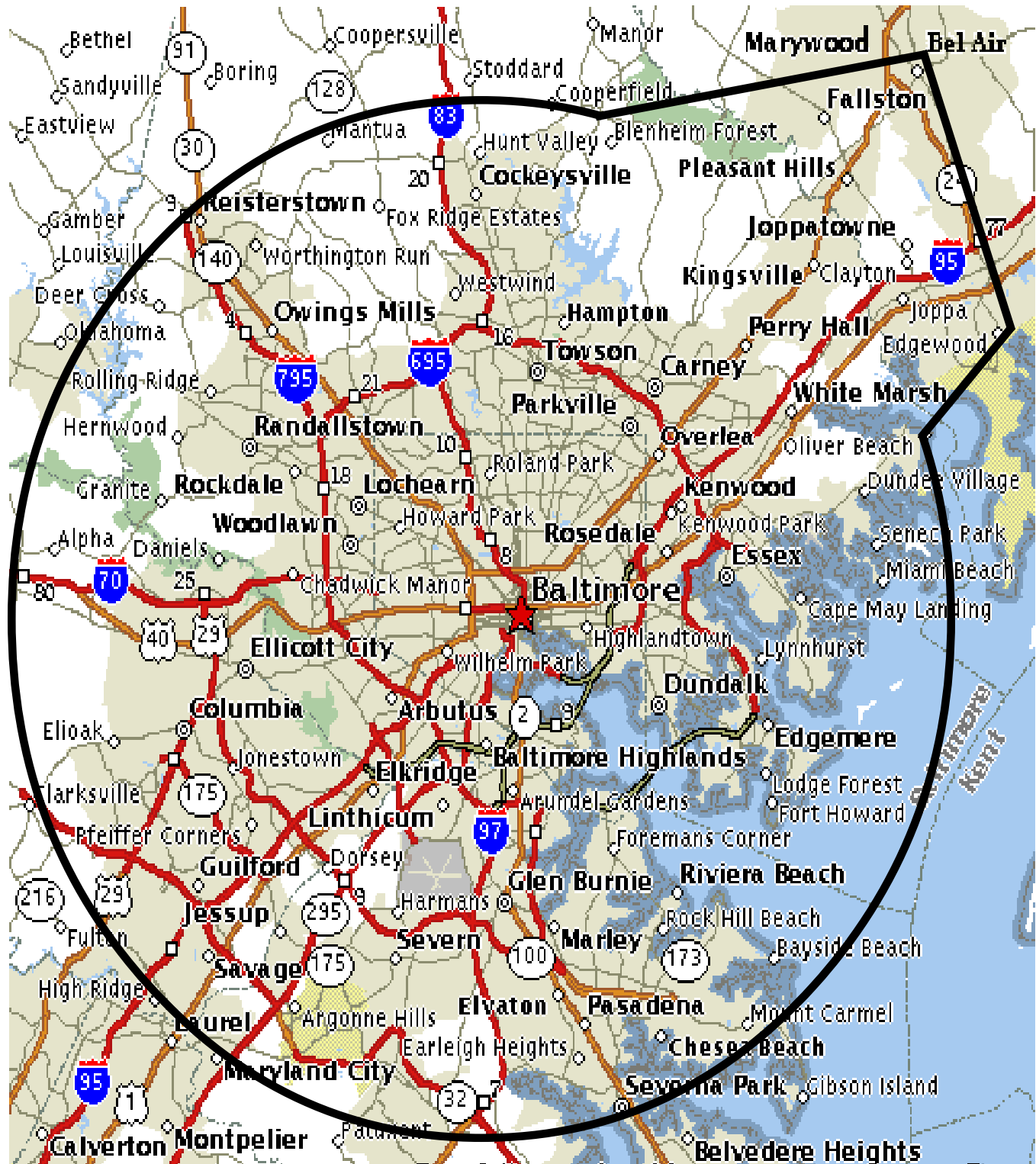

*For deliveries outside of our standard delivery zone,
please contact your sales representative.*

Application For Credit

Please detach and fax to : 410-325-2240 (Page 1 of 2)

Mill Supply Company Inc.
Moravia Industrial Park
6210 Frankford Avenue
Baltimore, MD. 21206
Phone 410-485-3343

To be filled out by Mill Supply

Location _____
Salesman _____

Purchaser(s) _____ Phone # _____
Address _____ City _____ State/Zip _____

Check One

Corporation Partnership Individual Building, Private Owner or Project
Officer, Partners or Spouse

<u>Name</u>	<u>Address</u>	<u>Title</u>	<u>Phone</u>
1. _____	_____	_____	_____
2. _____	_____	_____	_____
3. _____	_____	_____	_____

Year Established : _____

Tax Status : Taxable Resale Tax Exempt # _____ Fax Certificate w/application

Trade References : (Please provide fax #'s)

<u>Name</u>	<u>Address</u>	<u>Title</u>	<u>Phone</u>	<u>Fax</u>
1. _____	_____	_____	_____	_____
2. _____	_____	_____	_____	_____
3. _____	_____	_____	_____	_____

Bank References :

Checking : _____

Contact : _____ Phone # _____

Lines of Credit : _____

Agreement :

It is understood that Mill Supply Company Inc. may impose a late fee of one and one-half (1-1/2) percent per month on any past due balances exceeding 30 days, and that the undersigned will pay all costs of collection and reasonable attorney's fees of 20%. The undersigned agrees that if credit is granted by Mill Supply Co. the undersigned will be responsible for all invoices as presented. I (we) certify the above information above to be true and accurate. You hereby consent to venue in any such action in the District or Circuit Court for Baltimore City, Maryland.

Signature _____

Signature _____

Application For Credit

Please detach and fax to : 410-325-2240 (Page 2 of 2)

**Mill Supply Company Inc.
Moravia Industrial Park
6210 Frankford Avenue
Baltimore, MD. 21206
Phone 410-485-3343**

In consideration of the granting and extending of credit by Mill Supply Co. Inc. to the persons or companies to whom credit extended pursuant to the above application, and in further consideration of the delivery of certain goods and materials to said persons or companies on the terms below. Mill Supply Co. Inc. is hereby authorized to charge interests at 1-1/2% per month on all accounts past due terms are net (30) days from date of invoice. In addition, the undersigned guarantee(s) payment of any late fees and costs of collection including a reasonable attorney's fee of twenty (20) percent. The undersigned further waive(s) notice of acceptance of this guarantee, notice of the sale and delivery of materials, notice of the amount of the indebtedness, and notice of any extensions of time for payment. The undersigned further waive(s) notice of any default or non-payment of the account by the said persons or companies and demand of every kind, nature and description. The undersigned authorizes Mill Supply Co. Inc. to charge to said account all order by any of us, or our agents until such time as you shall receive written notice to the contrary. This is a continuing and absolute guarantee and shall not be affected by any oral modifications or additions.

Signature _____

Signature _____

Probable Monthly Requirements : \$ _____

Bill To Address : _____

Ship To Address: _____

To be filled out by Mill Supply

Credit Limit : \$ _____

Date Approved : _____

Approved By : _____

Customer Account # : _____

Table of Contents

Industrial.....	Page 1
Safety.....	Page 27
Tools.....	Page 43
Builders Hardware.....	Page 95
Construction & Building Supplies...	Page 149
Lawn & Garden.....	Page 175
Janitorial.....	Page 189
Automotive.....	Page 209
Paint & Sundries.....	Page 215
Maintenance.....	Page 223
Electrical.....	Page 231
Plumbing.....	Page 259
Index - Item #.....	Page 311
Index - Alphabetical.....	Page 333

Terms & Conditions

Product Description

Our catalog has been designed to enhance product selection by our customers. All items are identified with an “M” (mill) number. In some instances, the manufacturer’s product number is listed as well. In cases where products are not available, we reserve the right to ship products of equal or superior quality. Illustrations are solely for descriptive purposes.

Minimum Order

Our minimum order is \$40.00

Backorder Policy

Unless specified, backorders will be honored at our option, depending upon quantities and/or dollar value.

Payment Terms

Standard terms are net 30 days. Invoices not paid within terms are subject to finance charges of 1-1/2% per month (annual rate of 18%). We reserve the right to hold orders until past due remittance is received. We accept Mastercard and Visa for payment purposes. No deductions are permitted without prior consent.

Delivery

Orders received by 3:00pm which meet our minimum order requirements will be delivered free of charge on the next business day in our standard delivery zone (See map on previous page).

Claims

It is the customer’s responsibility to report damages or shortages within 5 (five) days after receipt. No claims will be honored after that date. Mill Supply Company, Inc’s liability is limited to the value of the material claimed. Customers may seek replacement for defective items through manufacturers stated warranty, if applicable.

Returns

No returns will be accepted without prior consent. An RGA number must be requested. We reserve the right to assess a restocking charge.

Special Order Items

These orders are subject to a deposit at seller’s option. Returns (if applicable) are subject to vendors restocking terms. Return freight charges are the sole responsibility of the customer.

The contents of this catalog, in part or whole, may not be reproduced without the consent of Mill Supply Company, Inc. We are not responsible for typographical or pictorial errors.



Industrial

Industrial



MOTOROLA

Master Lock



**AMERICAN
LOCK**

Campbell

DEWALT

RAYOVAC



**MITSUBISHI
HEAVY INDUSTRIES, LTD.**

3M

USG

**PRECISION
ABRASIVES** Quality Abrasives
for Precision Work

WESCO
MANUFACTURING COMPANY

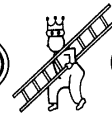

HOLD-ZIT
STRAPS

National
Hardware
Makers
Since 1901



MILL SUPPLY CO., INC.

Phone (410) 485-3343
Fax (410) 325-2240

Toll Free 1-800-817-8183

HAND & APPLIANCE TRUCKS

Pneumatic Wheel Hand Truck :

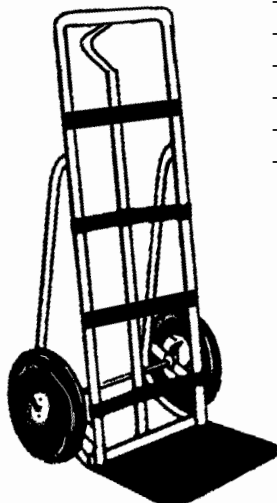

- 600 lb capacity
- 51-1/2" tall; 21-1/2" wide
- Weighs only 26 lbs
- 7-1/2" deep 14" wide nose plate
- 16 gauge frame
- Full pneumatic 10" wheels with ball bearings
- P handle design for easy handling

Item # M13355
U/M - Each

Magnesium Appliance Truck :

- Fully welded frame and handles for maximum strength and durability
- Magnesium is 33% lighter than aluminum and is the worlds lightest structural metal
- Auto-rewind belt tightening system
- 2" wide heavy duty web belt
- 6"x2" moldon rubber wheels with .625" ball bearings
- Non-marking grey vinyl on a all contact surfaces securely mounted to truck
- Stair climbers
- Weighs 37 lbs
- 750 lb. capacity

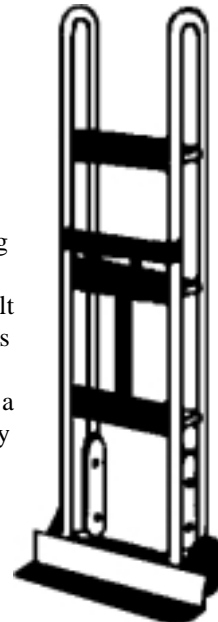

Item # M13361
U/M - Each

Steel Appliance Truck :

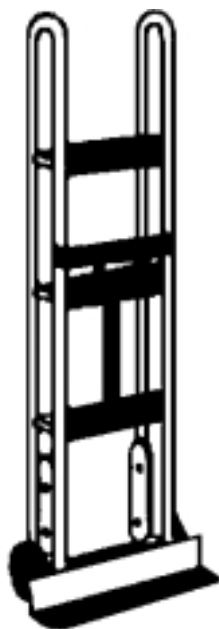

- Double welded joints for maximum durability
- Rugged tubular steel construction
- Auto-rewind belt tightening system
- 2" wide heavy duty web belt
- Aluminum center moldon rubber wheels with .625" ball bearings
- Non-marking grey vinyl on all contact surfaces securely mounted to truck
- Stair climbers
- Weighs 52 lbs
- 750 lb. capacity

Item # M13364
U/M - Each



MILL SUPPLY CO., INC.

Phone (410) 485-3343
Fax (410) 325-2240

Toll Free 1-800-817-8183

Industrial



MOTOROLA

New- Motorola XTN 2-way Radios.

New Features Include :

- **Large LCD display** : shows battery life, transmitting strength, code and frequency #'s - Makes programing simple and easy
- **Manufactured to military spec. 810, and IP54** : Simply put, they are stronger more weatherproof than the previous Spirit radios, these radios are manufactured to take all the abuse you can dish out
- **Manager Lockout** : Ever get the call that one or more radios do not work, only to find that someone accidentally changed the frequency or code ? With manager lockout you have the ability to restrict all radio settings, so you stay in constant contact
- **RSSI Signal Strength** : 15% more range than previous Spirit radios, signal is clearer at higher volumes
- **Call Tones** : Allows users to send up to 4 seperate tones as opposed to just talking to other radios
- **Battery Gauge** : Now you don't have to guess the battery life, LCD display shows exactly how much battery life remains
- **New NiMH Battery** : The M-Series radios with each battery recharge, the battery life actually decreases upon each charge. The new NiMH batteries in the XTN radios take a new charge to a full charge every time. Also longer battery life, up to 15 hours* as opposed to 8 on the M-Series
- **AA Battery Compatible** : Forget to recharge your battery or simply can't get to a charger ? The XTN will run for up to 24 Hours* on 4 AA batteries that fit right in the NiMH battery slot
- **More Frequencies** : 56 UHF and 27 VHF along with 120 private line codes - So you more likely to find a clear channel with no interference
- **Cloning** : Programing radios a hassle ? No problem, these radios have split second cloning. Set the first radio and using the optional cloning multi-charger tray, the additional radios will be automatically cloned to match the first one
- **Scramble (2 watt models only)** : Need to get private information to someone alone or part of a group of radios ? With scramble mode active the person(s) you want will get the transmission, everyone else will get a garbled, unclear transmission
- **Compatible** : Can be programmed to all existing Spirit GT, Spirit HP, Spirit M & S radios. Also many accessories that the M Series radios uses the XTN uses too

NEW & IMPROVED

New LCD display lets the user know the status of all vital radio functions and features.

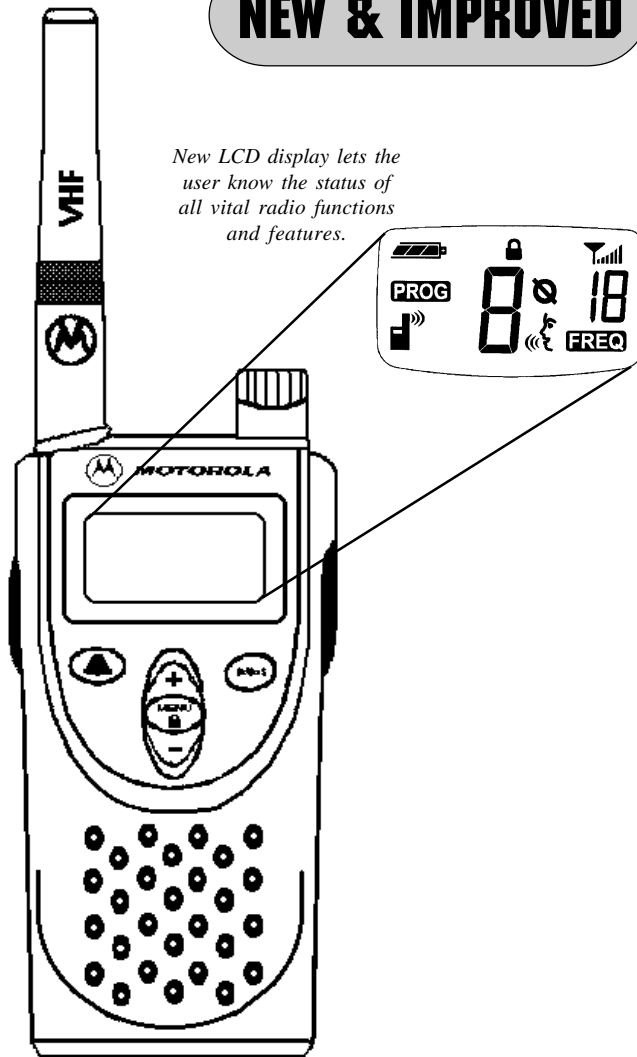

* 15 hours of battery life on 1 watt units,
13 hours of battery life on 2 watt units,
22 hours of battery life with AA batteries 1 watt units,
24 hours of battery life with AA batteries 2 watt units.

XTN SERIES



MILL SUPPLY CO., INC.

Phone (410) 485-3343
Fax (410) 325-2240

Toll Free 1-800-817-8183

Industrial



Motorola XTN 2-way Radios :

XTN SERIES

Item #	U/M	Model	Power	# Channels	Range Indoors	Range Outdoors	Range WHSE
M18025	Each	XV1100	1 Watt	1 VHF	8 Flrs.	5 Miles	150,000 Sf.
M18031	Each	XV2100	2 Watts	1 VHF	10 Flrs.	6 Miles	180,000 Sf.
M18013	Each	XU1100	1 Watt	1 UHF	15 Flrs.	5 Miles	200,000 Sf.
M18019	Each	XU2100	2 Watts	1 UHF	20 Flrs.	6 Miles	250,000 Sf.

Radio Accessories

Only accessories marked with the XTN logo can be used with the XTN radios.

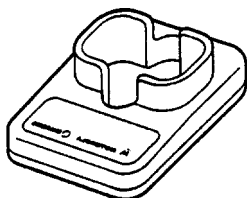

10 Hour drop in charger tray.
Compatible with all S,M series radios.
Can be use to charge spare NiCad battery. Charging time 10 hours.

Item # M18002
U/M-Each

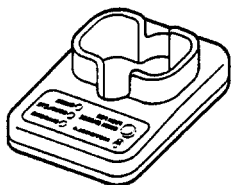

3 Hour drop in charger tray.
Compatible with all S,M series radios.
Can be use to charge spare NiCad battery. Charging time 3 hours.

Item # M18003
U/M-Each



Battery Pack / NiCad
Fits all S,M series radios. Should be replaced every 12 months for maximum performance.

Item # M18006
U/M-Each

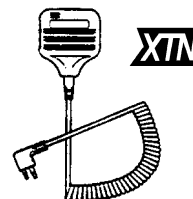

Remote speaker Mic.
Ideal for noisy areas to keep the sound close to the ear and provides easy talkback.

Item # M18088
U/M-Each

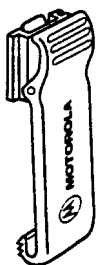

Spring Action Belt Clip.
Fits all S,M series radios.

Item # M18055
U/M - Each

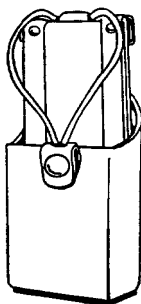

Leatherette Case w/Belt loop.
Fits all S,M series radios.

Item # M18061
U/M - Each

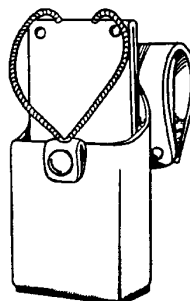

Leatherette Case w/Swivel Belt loop.
Fits all S,M series radios.

Item # M18062
U/M - Each



Replacement Antennas.
Replaces broken or lost antenna.

Item # M18075
(For VHF radios.)

Item # M18076
(For UHF radios.)

U/M - Each



MILL SUPPLY CO., INC.

Phone (410) 485-3343
Fax (410) 325-2240

Toll Free 1-800-817-8183

Industrial

WOOD & ALUMINUM STEPLADDERS

Wood Stepladder features:

- Manufactured from pine
- Non-slip steps

MANUFACTURER CERTIFIES
COMPLIANCE TO
ANSI STANDARDS

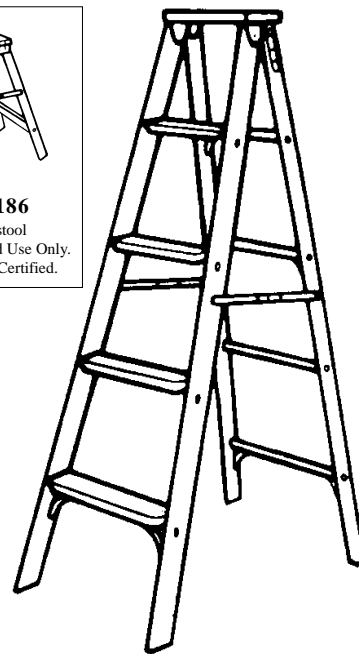

Item #	U/M	Size	Type	Rating
M13186	Each	2'	III	200 lbs.
M13188	Each	3'	I	250 lbs.
M13198	Each	4'	I	250 lbs.
M13204	Each	5'	I	250 lbs.
M13210	Each	6'	I	250 lbs.
M13214	Each	7'	I	250 lbs.
M13216	Each	8'	I	250 lbs.
M13222	Each	10'	I	250 lbs.
M13228	Each	12'	I	250 lbs.

Aluminum Stepladder features:

- Durable Plastic Top
- Auto-lock Pail Shelf
- Pinch-proof spreaders
- Slip Resistant Steps

All Type I Ladders also include:

- High Impact Molded Blue Plastic Top
- 3" Double Riveted Ribbed Steps
- Exterior Molded Paint Bucket Hook

MANUFACTURER CERTIFIES
COMPLIANCE TO
ANSI STANDARDS

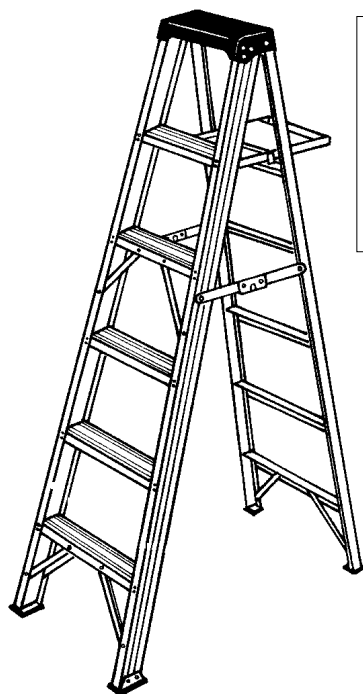

Item #	U/M	Size	Type	Rating
M13004	Each	27"	I	250 lbs.
M13006	Each	3'	II	225 lbs.
M13008	Each	4'	II	225 lbs.
M13009	Each	5'	II	225 lbs.
M13011	Each	6'	II	225 lbs.
M13014	Each	8'	II	225 lbs.
M13017	Each	3'	I	250 lbs.
M13018	Each	4'	I	250 lbs.
M13024	Each	5'	I	250 lbs.
M13030	Each	6'	I	250 lbs.
M13032	Each	7'	I	250 lbs.
M13036	Each	8'	I	250 lbs.
M13042	Each	10'	I	250 lbs.



MILL SUPPLY CO., INC.

Phone (410) 485-3343
Fax (410) 325-2240

Toll Free 1-800-817-8183

Industrial

FIBERGLASS STEP & ALUMINUM EXTENSION LADDERS

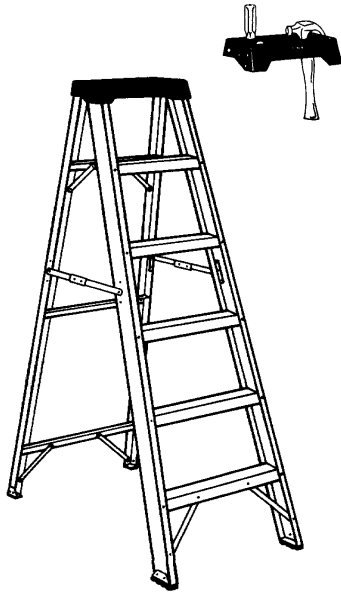

Fiberglass Stepladder features:

- Non-Conductive green fiberglass rails
- High impact, moulded plastic top cap with deep tool tray and tool holes
- Inside pinch proof spreaders
- Single riveted 3" wide treads
- 1-1/2" x 3" slip resistant steps
- Exterior moulded paint bucket hook



Item #	U/M	Size	Type	Rating
M13151	Each	4'	I	250 lbs.
M13153	Each	5'	I	250 lbs.
M13156	Each	6'	I	250 lbs.
M13162	Each	8'	I	250 lbs.

Aluminum Extension Ladder features:

- 1-5/8" Corrugated "D" Rungs
- Die-cast Aluminum Double Rung Locks
- Combination Shoes with Spur Points
- 3" Modified I-Beam Rail
- Mar-resistant Yellow End Caps & Rail Enclosures

All Type I Ladders also include:

- 3" Heavy-duty I-Beam Rails
- Vinyl Coated Blue Loop End Caps



Item #	U/M	Length	Working Length	Type	Rating
M13100	Each	16'	13'	II	225 lbs.
M13102	Each	20'	17'	II	225 lbs.
M13108	Each	24'	21'	II	225 lbs.
M13112	Each	28'	25'	II	225 lbs.
M13119	Each	32'	28'	II	225 lbs.
M13124	Each	36'	32'	II	225 lbs.
M13126	Each	40'	35'	II	225 lbs.
M13061	Each	16'	13'	I	250 lbs.
M13066	Each	20'	17'	I	250 lbs.
M13070	Each	24'	21'	I	250 lbs.
M13078	Each	28'	25'	I	250 lbs.
M13090	Each	32'	28'	I	250 lbs.
M13093	Each	36'	32'	I	250 lbs.
M13096	Each	40'	35'	I	250 lbs.

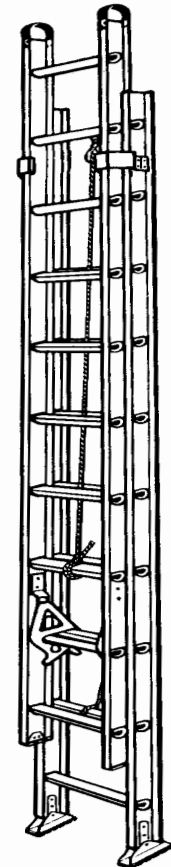

MILL SUPPLY CO., INC.

Phone (410) 485-3343
Fax (410) 325-2240

Toll Free 1-800-817-8183

Industrial

Master Lock

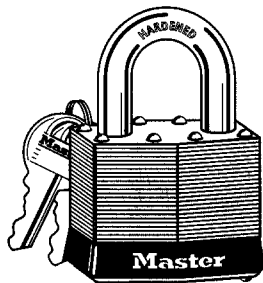

#1 Master Padlock :

- 1-3/4" wide laminated steel body for superior strength
- Hardened steel shackle for extra cut resistance
- 4-pin cylinder helps prevent picking
- Dual locking levers provide extra pry resistance
- More than 3,000 key changes for maximum pick resistance

Item #	U/M	Key #	Shackle "A"	Shackle "B"	Shackle "C"
M14106	Each	2126	5/16"	15/16"	3/4"
M14109	Each	2357	5/16"	15/16"	3/4"
M14104	Each	KD	5/16"	2-1/2"	3/4"

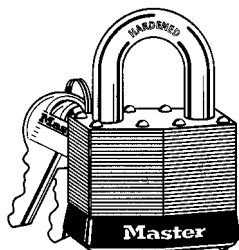
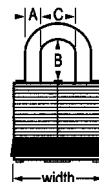

#3 Master Padlock :

- 1-1/2" wide laminated steel body for superior strength
- Hardened steel shackle for extra cut resistance
- 4-pin cylinder helps prevent picking
- Dual locking levers provide extra pry resistance
- More than 3,000 key changes for maximum pick resistance

Item #	U/M	Key #	Shackle "A"	Shackle "B"	Shackle "C"
M14115	Each	0536	9/32"	3/4"	5/8"
M14117	Each	KD	9/32"	3/4"	5/8"
M14118	Each	0536	9/32"	1-1/2"	5/8"

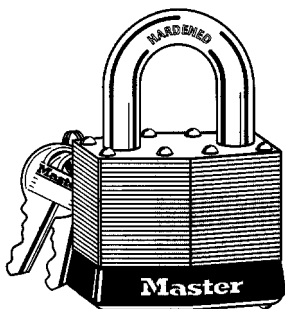
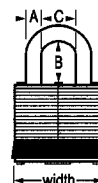

#5 Master Padlock :

- 2" wide laminated steel body for superior strength
- Hardened boron alloy for superior cut resistance
- 4-pin cylinder helps prevent picking
- Dual locking levers provide extra pry resistance
- More than 3,000 key changes for maximum pick resistance

Item #	U/M	Key #	Shackle "A"	Shackle "B"	Shackle "C"
M14130	Each	A389	3/8"	1"	15/16"
M14133	Each	0536	3/8"	1"	15/16"
M14128	Each	KD	3/8"	1"	15/16"

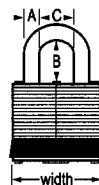

MILL SUPPLY CO., INC.

Phone (410) 485-3343
Fax (410) 325-2240

Toll Free 1-800-817-8183

Industrial

Master Lock

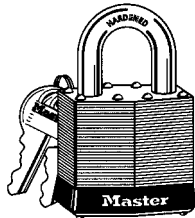

#7 Master Padlock :

- 1-1/8" wide laminated steel body for superior strength
- Standard steel shackle
- 4-pin cylinder helps prevent picking
- Minimal clearance helps prevent prying
- More than 1,500 key changes for maximum pick resistance

Item #	U/M	Key #	Shackle "A"	Shackle "B"	Shackle "C"
M14140	Each	P802	3/16"	9/16"	1/2"
M14139	Each	KD	3/16"	9/16"	1/2"

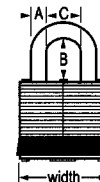

#500 Master Padlock :

- 1-3/4" wide laminated steel body for superior strength
- Steel shackle for strong cut resistance
- Warded locking mechanism minimizes jamming from dirt and grime

Item #	U/M	Key #	Shackle "A"	Shackle "B"	Shackle "C"
M14124	Each	3701	9/32"	13/16"	13/16"

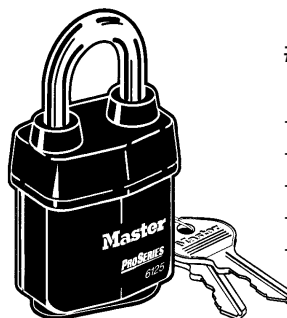
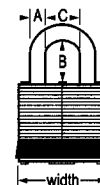

#6125 Master Padlock :

PROSERIES

- Weather Tough design resists the elements
- Removable cylinder can be replaced or repinned
- 2-3/8" wide laminated steel body for superior strength
- Hardened boron alloy shackle for superior cut resistance
- Unique FlexFit keyway cover minimizes jamming

Item #	U/M	Key #	Shackle "A"	Shackle "B"	Shackle "C"
M14136	Each	16G668	3/8"	1-3/8"	7/8"

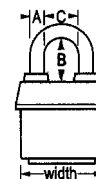

MILL SUPPLY CO., INC.

Phone (410) 485-3343
Fax (410) 325-2240

Toll Free 1-800-817-8183

Industrial

AMERICAN LOCK®



#30 & 31 American Padlocks :

- Anodized **Aluminum** solid body with gun metal blue finish and case hardened, corrosion-resistant, steel plated shackle
- Standard solid steel cover plate
- Steel ball locking mechanism
- 5-pin non-rekeyable cylinder
- 1-3/4" wide by 3/4" thick body; 5/16" shackle diameter

Item #	U/M	Key #	American #	Shackle length
M14023	Each	42427	30	1"
M14027	Each	KD	30	1"
M14033	Each	KD	31	1-1/2"



#40 American Padlock :

- Solid **Brass** body with a solid steel cylinder cover plate
- Corrosion-resistant, plated steel shackle
- Steel double ball locking mechanism
- 5-pin non-rekeyable cylinder
- 1-1/2" wide by 3/4" thick body; 1/4" shackle diameter

Item #	U/M	Key #	Shackle length
M14036	Each	22548	1"
M14039	Each	24468	1"
M14041	Each	KD	1"



#5101 American Padlock :

- Chrome-plated hardened Solid **Steel** body with a solid steel cover plate
- Case hardened, chrome-plated, boron alloy steel shackle
- Stainless Steel double ball locking mechanism
- 5-pin rekeyable, interchangeable and easily serviced
- 1-1/2" wide by 3/4" thick body; 1/4" shackle diameter

Item #	U/M	Key #	Shackle length
M14047	Each	42478	1-1/2"



MILL SUPPLY CO., INC.

Phone (410) 485-3343
Fax (410) 325-2240

Toll Free 1-800-817-8183

Industrial

AMERICAN LOCK[®]

#2000 American Padlock :

- Triple chrome-plated hardened solid steel one-piece padlock with locking bolt
- 6-pin rekeyable cylinder for maximum security
- Excellent protection for; commercial buildings, industrial plants, public works facilities & utilities, garage and storage buildings, and vending machines
- 2-7/8" diameter, 1-1/2" thick
- Keyed different
- Use # M14073 or # M14072 Hasp

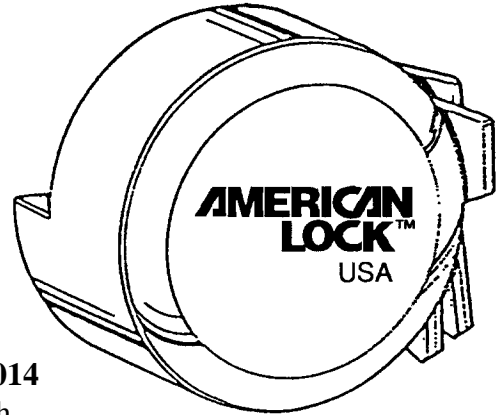

Item # M14014
U/M - Each

#825 American Hasp :

- Hardened Steel straight bar, 7-1/4" long, 1-5/8" wide

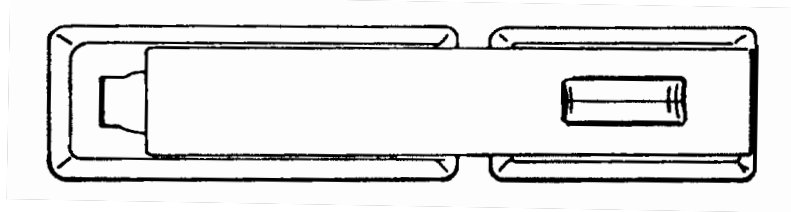

Item # M14073
U/M - Each

#535 American Hasp :

- Hardened Steel, centered hole, 5" long, 2" wide

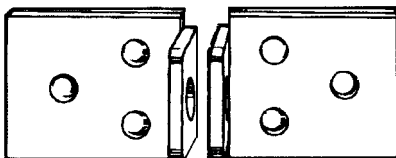

Item # M14072
U/M - Each

#850 American Hasp :

- Hardened steel, 90 deg. angle bar, 4-1/4" long, 1-5/8" wide

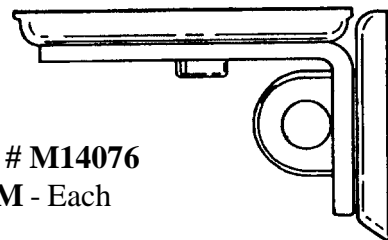

Item # M14076
U/M - Each



MILL SUPPLY CO., INC.

Phone (410) 485-3343
Fax (410) 325-2240

Toll Free 1-800-817-8183

Industrial

PADLOCKS & HASPS

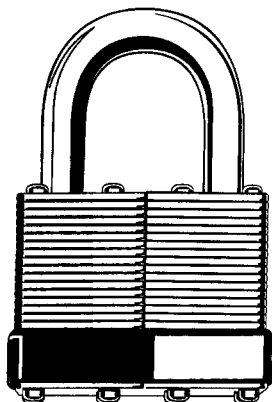

Laminated Padlocks :

- Single Bumper, Standard Shackle
- Solid brass cylinder
- Pin tumbler mechanism
- Laminated steel casing
- Solid rivet construction
- Chromitized finish
- Hardened steel shackle

Item #	U/M	Key #	Size
M14239	Each	KD	1-1/4"
M14240	Each	KA	1-1/4"
M14241	Each	KD	1-1/2"
M14242	Each	KA	1-1/2"
M14246	Each	KD	2"

Swivel Staple Safety Hasp :

- Zinc plated
- Sold with screws

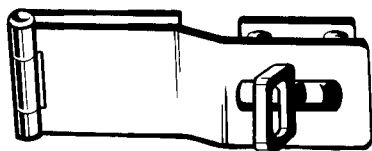

Item #	U/M	Size
M18775	Each	3-1/4"
M18783	Each	4-1/2"
M18890	Each	6"

Safety Hasp :

- Zinc plated
- Sold without screws

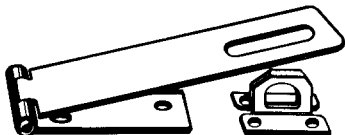

Item #	U/M	Size
M18772	Each	2-1/2"
M18774	Each	3-1/4"
M18782	Each	4-1/2"
M18784	Each	6"

Master Lock

#706 Master Hasp :



- 6" hardened steel super security hasp
- Tapered design, with rolled edges to conceal screws and prevent prying
- Ribbed for maximum strength.
- Rustproofed for extended wear
- Complete with seven mounting screws plus reinforcing bolt for added strength when needed

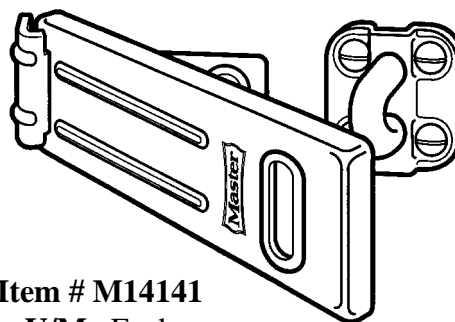

Item # M14141
U/M - Each

Double Hinge Safety Hasp :

- Zinc plated
- Sold with screws

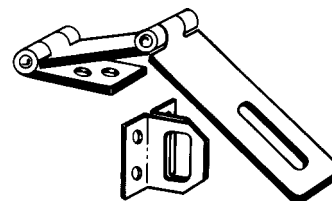

Item #	U/M	Size
M18881	Each	3-1/4"
M18885	Each	4-1/2"



MILL SUPPLY CO., INC.

Phone (410) 485-3343
Fax (410) 325-2240

Toll Free 1-800-817-8183

Industrial

RUBBER STRAPS, ROPE & CHAIN

Rubber Tie-Down Strap :

- Attaches and removes easily
- Holds tightly
- Prevents flapping
- Weather and Ozone resistant
- Eliminates rope tying
- Reinforced ends help prevent hooks from pulling out
- Available in wide variety of sizes

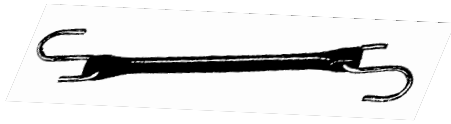

Item #	U/M	Size
M14777	Each	15"
M14781	Each	22"
M14784	Each	31"

Manila Rope :

- This natural fiber rope has excellent abrasion resistance
- Manila (or abacca) rope is the most common used
- Sold by the coil only.

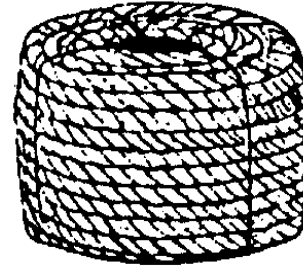

Item #	U/M	Size	Ft. per Roll
M14653	Roll	1/4"	1200'
M14656	Roll	3/8"	600'
M14659	Roll	1/2"	600'
M14662	Roll	3/4"	600'

Proof Coil Chain :

Campbell®

- Excellent general-purpose chain of standard commercial quality
- Proof tested. (system 3)
- Finish Blu-Krome
- **Do not use for overhead lifting**
- Sold by the foot

Bolt Cutters
Page 69

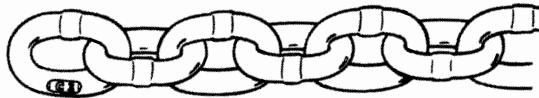

Item #	U/M	Size	Load Limit	Ft. per Pail
M14506	Foot	3/16"	800 lbs.	250'
M14518	Foot	1/4"	1300 lbs.	141'
M14530	Foot	5/16"	1900 lbs.	92'
M14542	Foot	3/8"	2650 lbs.	63'
M14545	Foot	1/2"	4500 lbs.	40'

Inco Double Loop Chain :

Campbell®

- For use in playground and gymnasium equipment *, animal chains, and many general-purpose applications
- Hot galvanized finish
- **Do not use for overhead lifting**
- Sold by the full box only

* The Playground Equipment Association has adopted the 1/0 Inco coil chain as a minimum size chain for swing sets.

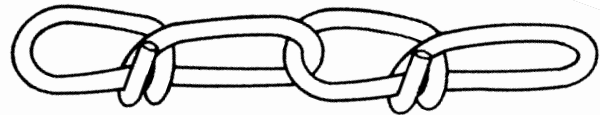

Item #	U/M	Size	Load Limit	Ft. per Box
M14566	Box	2/0	255 lbs.	100'
M14578	Box	4/0	365 lbs.	100'



MILL SUPPLY CO., INC.

Phone (410) 485-3343
Fax (410) 325-2240

Toll Free 1-800-817-8183

Industrial

INDUSTRIAL HARDWARE

Barrel Bolts :

- Zinc plated
- Sold by each

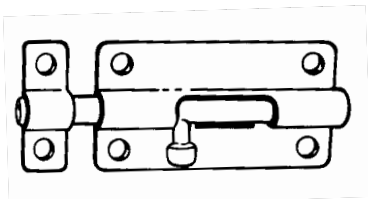

Item #	U/M	Size
M18901	Each	2-1/2"
M18904	Each	3"
M18906	Each	4"
M18905	Each	5"

Automatic Gate Latches :

- Zinc plated
- Sold by each

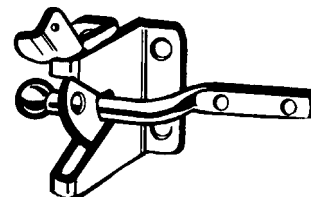

Item # M38502
U/M - Each

Eye Bolts :

- Zinc plated
- Sold in packs only
- With hex nut

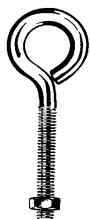

Item #	U/M	Size	Packed
M18681	Pack	3/16" x 2"	2 per
M18665	Pack	1/4" x 2"	2 per
M18673	Pack	1/4" x 3"	2 per
M18675	Pack	1/4" x 5"	2 per
M18693	Pack	5/16" x 4"	2 per
M18683	Pack	3/8" x 3"	2 per

Large Eye Screw Eyes :

- Zinc plated
- Sold in packs only

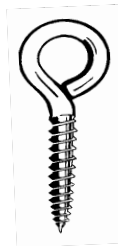

Item #	U/M	Size	Packed
M18593	Pack	"0" 2-7/8"	2 per
M18601	Pack	"8" 1-5/8"	6 per
M18599	Pack	"12" 1-3/16"	10 per

Hook And Eyes :

- Zinc plated

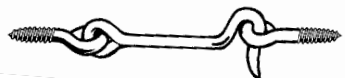

Item #	U/M	Size	Packed
M18569	Pack	1-1/2"	2 per
M18573	Pack	2"	2 per
M18581	Pack	3"	2 per
M18585	Each	4"	1 per
M18589	Each	6"	1 per

S Hooks :

- Zinc plated



Item #	U/M	Size	Packed
M18613	Pack	1"	6 per
M18617	Pack	1-1/2"	4 per
M18621	Pack	2"	2 per
M18625	Each	2-1/2"	1 per



MILL SUPPLY CO., INC.

Phone (410) 485-3343
Fax (410) 325-2240

Toll Free 1-800-817-8183

Industrial

INDUSTRIAL HARDWARE

Clevis Slip Hook :

- Zinc plated
- Meets Grade 43 Hook Specifications
- **Do not use for overhead lifting, support of human weight, athletic equipment or playground equipment**

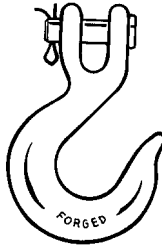

Item #	U/M	Size
M18753	Each	1/4"
M18761	Each	5/16"

Clevis Grab Hook :

- Zinc plated
- Meets Grade 43 Hook Specifications
- **Do not use for overhead lifting, support of human weight, athletic equipment or playground equipment**



Item #	U/M	Size
M18742	Each	1/4"
M18743	Each	5/16"

Cable Clamps :

- Zinc plated
- Meets torque valve of Federal Specifications FF-C-450D, Type 1, Class 2.
- Sold in packs only

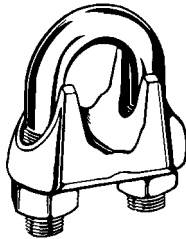

Item #	U/M	Size	Packed
M18603	Pack	1/8"	3 per
M18607	Pack	3/16"	3 per
M18611	Pack	1/4"	2 per

Anchor Shackle :

- Galvanized finish
- With screw pin

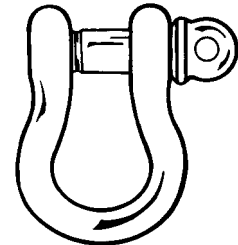

Item #	U/M	Size
M18763	Each	1/4"
M18764	Each	5/16"

Bolt Snap :

- Solid Bronze

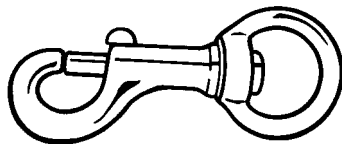

Item #	U/M	Size
M18725	Each	3/4" x 3-5/16"
M18729	Each	13/16" x 3-1/4"
M18732	Each	1-1/4" x 4-3/4"
M18735	Each	1-1/4" x 5"

Double Bolt Snap :

- Solid Bronze

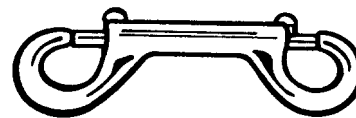

Item #	U/M	Size
M18739	Each	3-7/16"



MILL SUPPLY CO., INC.

Phone (410) 485-3343
Fax (410) 325-2240

Toll Free 1-800-817-8183

Industrial

INDUSTRIAL HARDWARE

Corner Irons :

- Zinc plated
- Sold by each without screws

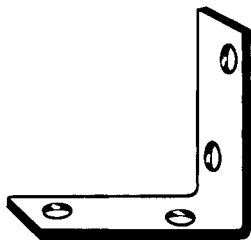

Item #	U/M	Size
M18508	Each	1" x 1/2"
M18509	Each	1-1/2" x 5/8"
M18514	Each	2" x 5/8"
M18517	Each	2-1/2" x 5/8"
M18525	Each	3" x 3/4"
M18529	Each	4" x 7/8"
M18533	Each	5" x 1"
M18536	Each	6" x 1-1/8"

Flat Corner Irons :

- Zinc plated
- Sold by each without screws

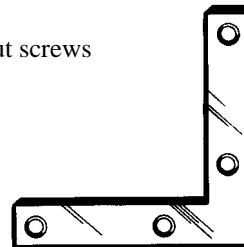

Item #	U/M	Size
M18539	Each	1-1/2" x 3/8"
M18544	Each	2" x 3/8"
M18546	Each	2-1/2" x 1/2"
M18549	Each	3" x 1/2"
M18553	Each	4" x 3/4"

Mending Plates :

- Zinc plated
- Sold in packs with screws



Item #	U/M	Size	Packed
M18559	Pack	2" x 1/2"	4 per
M18561	Pack	3" x 5/8"	4 per
M18563	Pack	4" x 5/8"	4 per

Screws
Page 169

Threaded Rod :

- Zinc plated Steel, National Coarse Threads
- Sold by the rod



Item #	U/M	Size	Length
M18951	Each	1/4"-20	36"
M18952	Each	5/16"-18	36"
M18953	Each	3/8"-16	36"
M18954	Each	7/16"-14	36"
M18955	Each	1/2"-13	36"
M18956	Each	5/8"-11	36"
M18957	Each	3/4"-10	36"



MILL SUPPLY CO., INC.

Phone (410) 485-3343
Fax (410) 325-2240

Toll Free 1-800-817-8183

HOSE CLAMPS & TAPE

Hose Clamps :

- #410 Stainless steel band housing
- Zinc plated steel slotted hex head screw
- For use with standard clamp applications
- Fits pipe & hose

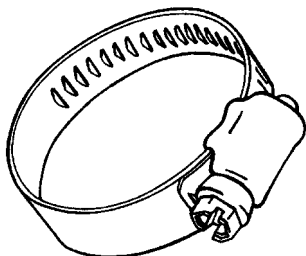

Item #	U/M	Size	Min. Dia.	Max. Dia.
M19001	Each	#4	7/32"	5/8"
M19010	Each	#6	7/16"	25/32"
M19016	Each	#8	1/2"	29/32"
M19103	Each	#10	9/16"	1-1/16"
M19115	Each	#12	11/16"	1-1/4"
M19123	Each	#16	13/16"	1-1/2"
M19127	Each	#20	13/16"	1-3/4"
M19143	Each	#28	1-5/16"	2-1/4"
M19150	Each	#32	1-9/16"	2-1/2"
M19159	Each	#36	1-13/16"	2-3/4"
M19167	Each	#40	2-1/16"	3"
M19175	Each	#48	2-9/16"	3-1/2"
M19195	Each	#72	4-1/8"	5"

Duct Tape :

- Cloth duct tape
- General Purpose
- Waterproof coated
- 2" x 60 yd.
- Duct tape is suitable for use on any surface for permanent or temporary application



Item # M10105
U/M - Roll

Masking Tape :

- General Purpose
- For masking metal, wood or paper
- Can be used on any clean dry surface

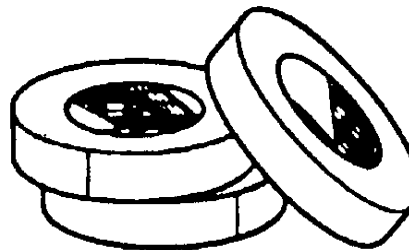

Item #	U/M	Size	Length
M10084	Roll	1"	60 yds.
M10090	Roll	2"	60 yds.
M10096	Roll	3"	60 yds.



MILL SUPPLY CO., INC.

Phone (410) 485-3343
Fax (410) 325-2240

Toll Free 1-800-817-8183

Industrial

TAPE - CONTINUED

Teflon Tape :

- Withstands temperatures up to 500 deg. F
- Joints never freeze or harden
- Withstands up to 5,000 PSI
- 1/2" x 520"



Item # M10019
U/M - Roll

Electrical Tape :

- All purpose tape
- UL listed
- Suitable for use at not more than 600 V and not more than 80 deg. C (176 deg. F)
- 3/4" x 60'



Item # M10044
U/M - Roll

3M Electrical Tape :

- Scotch Super 33+ Vinyl Electrical Tape
- UL listed. Flame retardant
- Professional quality
- Stretchy, comfortable, vinyl plastic
- Insulates and protects against abrasion, weather, water, solvent splashes, and chemicals
- 3/4" x 66'



Item # M10040
U/M - Roll

3M Rug & Carpet Tape :

- Flexible, moisture resistant, long lasting
- Secures Rugs & Carpets to floor
- One piece removal
- 1-1/4" x 300'



Item # M10070
U/M - Roll

Packing Tape :

- Strong, water resistant polypropylene meets postal regulations
- Clear (2" x 55 yds)



Item # M10110
U/M - Roll

Barricade Tape :

- This polyethylene product can be quickly and easily placed to provide warning of physical hazards, or dangerous situations, such as buried pipes, wires, cables, etc., thus preventing costly injuries, damage, and down time
- Yellow (3" x 300')



Item # M10136
U/M - Roll

Flagging Tape :

- Flagging tapes provide a lead free embossed plastic film that is easy to tie and tear. The colors are highly visible and do not fade after use in the elements
- 1" x 150' Roll

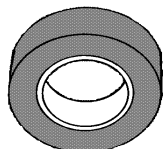

Item#	U/M	Color
M10130	Roll	Red
M10132	Roll	Orange
M10134	Roll	Lime



MILL SUPPLY CO., INC.

Phone (410) 485-3343
Fax (410) 325-2240

Toll Free 1-800-817-8183

TAPE - CONTINUED

Aluminum Foil Tape :

- Weatherproof tape for repairing rainspouts, gutters and other metal products including duct
- 2" x 50 yds



Item # M10060
U/M - Roll

Joint Tape :

- For all drywall applications
- 2" x 50 yds

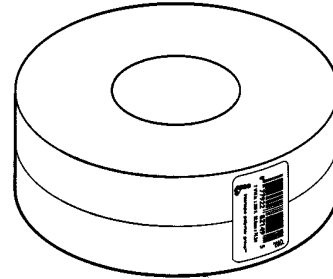

Item # M10022
U/M - Roll

Pro-Mesh Tape :

- Simple, Quick, and Easy
- Professional results
- Self-Adhesive Glass Mesh Patch / Joint Tape



Repairs severe cracks

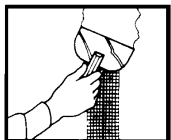

Seams new plaster joints

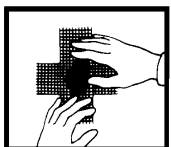

Repairs holes



Item #	U/M	Size
M10029	Roll	2" x 36'
M10032	Roll	2" x 300'



MILL SUPPLY CO., INC.

Phone (410) 485-3343
Fax (410) 325-2240

Toll Free 1-800-817-8183

Industrial

SANDING PRODUCTS

Drywall Sheets :

- 4-3/16" x 11"
- 100 Sheets per box

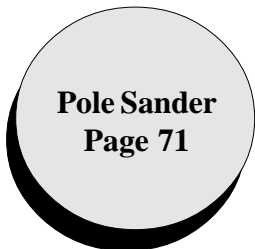

Sanding Sponge :

- Two sanding grits on one sponge
- Flexible sander for flat or contoured surfaces
- Wet or dry sanding
- Fine & Medium
- 2-3/4" x 4" x 1"



Item #	U/M	Grit
M16503	Box	80D
M16505	Box	100C

Item # M16913
U/M - Each

Cloth Belts :

- Premium Aluminum Oxide belts are for all medium to heavy duty metalworking applications. Quick stock removal and excellent finishing characteristics
- 3" x 24"
- Closed Coat
- Sold by the Each

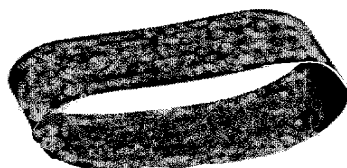

Floor Rolls :

- Silicon Carbon Resin
- Rolls are 8" x 50 yd.
- Sold by the Roll

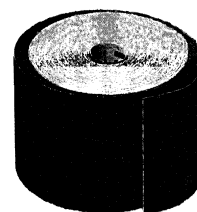

Item #	U/M	Grit
M16757	Each	100
M16769	Each	150

Item #	U/M	Grit
M16624	Roll	80E
M16625	Roll	100E

* Cloth Belts are available that are not pictured in this catalog. (Contact your sales representative for more information).



MILL SUPPLY CO., INC.

Phone (410) 485-3343
Fax (410) 325-2240

Toll Free 1-800-817-8183

Industrial

SANDING PRODUCTS

Garnet Paper :

- Garnet is a natural, mined abrasive grain that is primarily used in the furniture and woodworking industries
- "A" weight sheets are for fine finishing work
- Sheets are 9" x 11"
- Sold by the Sheet

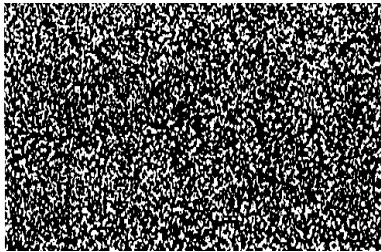

Item #	U/M	Grit	Qty. per Box
M16573	Each	180A	100/ea

Emery Cloth :

- Emery Cloth is a natural or mined abrasive that is not hard enough for production grinding of metal products. Emery Cloth is generally black in color and is used for general maintenance, light cleaning, and polishing of metal surfaces
- Sheets are 9" x 11"
- Sold by the Sheet

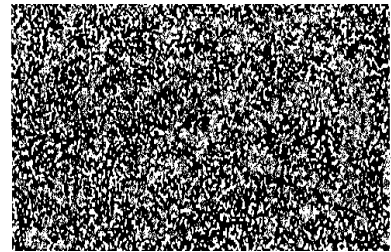

Item #	U/M	Grit	Qty. per Box
M16739	Each	Fine	50/ea
M16745	Each	Medium	50/ea
M16747	Each	Coarse	50/ea

A/O Paper :

- C&D weight sheets are a heavier paper used for rapid stock removal with minimal loading and glazing. The "A" weight paper is for fine finishing and contour sanding. Both products are used for woodworking, plastics, metal, and painted metal surfaces
- Sheets are 9" x 11"
- Sold by the Sheet

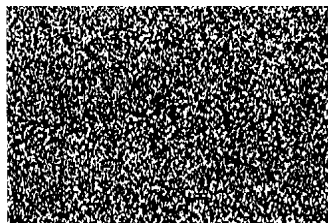

Item #	U/M	Grit	Qty. per Box
M16554	Each	50D	50/ea
M16555	Each	60D	50/ea
M16556	Each	80A	50/ea
M16559	Each	100C	100/ea
M16565	Each	120A	100/ea



MILL SUPPLY CO., INC.

Phone (410) 485-3343
Fax (410) 325-2240

Toll Free 1-800-817-8183

Industrial

SANDING PRODUCTS

Resin Fibre Sanding Discs :

- Premium Aluminum Oxide grain
- Excellent for weld grinding, metal working, fiberglass, and plastic applications
- 7" x 7/8"
- Sold by the Disc

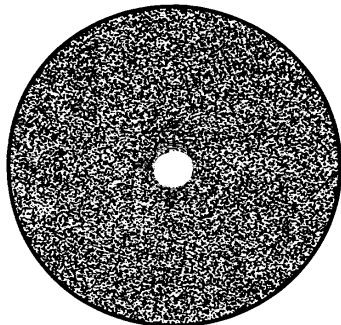

Item #	U/M	Grit	Qty. per Box
M16859	Each	16	25/ea
M16865	Each	24	25/ea
M16871	Each	36	25/ea
M16877	Each	50	25/ea
M16883	Each	60	25/ea
M16889	Each	80	25/ea
M16891	Each	100	25/ea
M16893	Each	120	25/ea

Resin Fibre Sanding Discs :

- Premium Aluminum Oxide grain
- Excellent for weld grinding, metal working, fiberglass, and plastic applications
- 4-1/2" x 7/8"
- Sold by the Disc

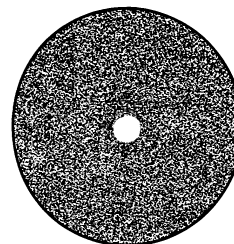

Item #	U/M	Grit	Qty. per Box
M16931	Each	24	25/ea

Steel Wool Pads :

- Hand size, specially constructed pads
- Packaged per sleeve
- 16 pads per sleeve
- Sold by the sleeve



Plumbers Sand Cloth :

- Aluminum Oxide 120 Grit
- Used for polishing and cleaning solder joint fittings
- Water resistant
- 1-1/2" x 10 yds

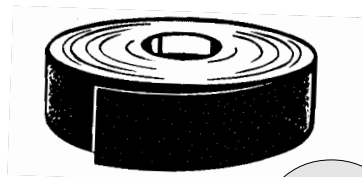

Item # M16952
U/M - Roll

Copper Fittings
Page 309

Item #	U/M	Size	Sleeves per Case
M17204	Sleeve	0000	12
M17208	Sleeve	000	12
M17211	Sleeve	00	12
M17215	Sleeve	0	12
M17219	Sleeve	1	12
M17223	Sleeve	2	12
M17227	Sleeve	3	12



MILL SUPPLY CO., INC.

Phone (410) 485-3343
Fax (410) 325-2240

Toll Free 1-800-817-8183

GRINDING & CUT-OFF WHEELS

Grinding Wheel :



- Stainless steel; for grinding harder metals such as stainless steel, super alloys, and other high tensile alloys. Aggressive removal and long life on ferrous metals
- A24R / Type 27
- 4-1/2" x 1/4" x 7/8"

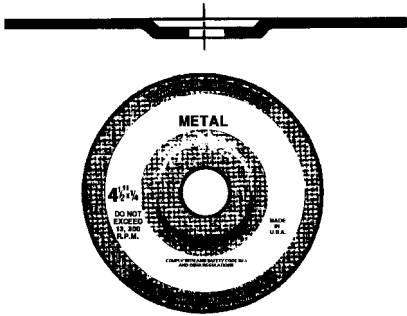

Item # M17060
U/M - Each



Grinding Wheel :



- Stainless steel; for grinding harder metals such as stainless steel, super alloys, and other high tensile alloys. Aggressive removal and long life on ferrous metals
- A30S / 8,700 Max RPM / 7" x 1/4 x 5/8-11

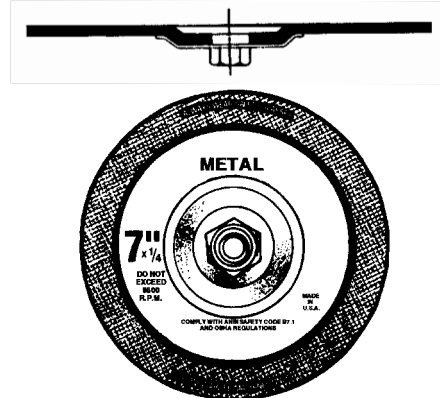

Item # M17072
U/M - Each

Cutoff Wheel :



- For high speed portable gas and electric saws
- For all job site profiles in mild and stainless steel including re-bar, pipe, and structural profiles
- 12" x 1/8" x 1"
- A24SB



Item # M17078
U/M - Each

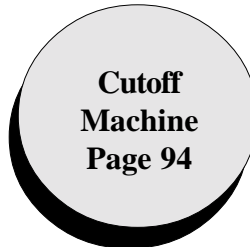

Cutoff Wheel :



- For high speed portable gas and electric saws
- Designed for rail cropping, this versatile grade will give straight, fast cuts on all sizes and weights of rail
- 14" x 1/8" x 1"
- A30PB



Item # M17132
U/M - Each



MILL SUPPLY CO., INC.

Phone (410) 485-3343
Fax (410) 325-2240

Toll Free 1-800-817-8183

Industrial

BATTERIES / POLAROID



Industrial Alkaline Batteries :

- Formulated specifically to exceed the everyday demands of tough industrial applications
- America's #1 selling industrial batteries
- Maximum performance dependability - for "must work" applications
- Better for the environment - mercury free formula
- Guaranteed against leakage
- Sold by the pack only



Item #	U/M	Size	Qty. per Pack
M17543	Pack	AAA	8 Each
M17537	Pack	AA	8 Each
M17549	Pack	C	6 Each
M17555	Pack	D	6 Each
M17531	Pack	9 Volt	6 Each

6 Volt Lantern Battery :

- Heavy Duty Industrial Series
- Spring Terminals
- Guaranteed against leakage
- Sold by the Each



Item # M17525
U/M - Each

6 Volt Lantern Battery :

- General Purpose Series
- Spring Terminals
- Guaranteed against leakage
- Sold by the Each



Item # M17519
U/M - Each

6 Volt Lantern Battery :

- General Purpose Series
- Screw Terminals
- Guaranteed against leakage
- Sold by the Each

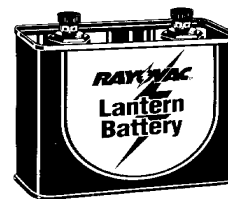

Item # M17513
U/M - Each

Instant Camera :

- Instant color photos with close-up focusing to 24", automatic exposure control, built in flash, auto focus lens, carrying case
- Lifetime warranty

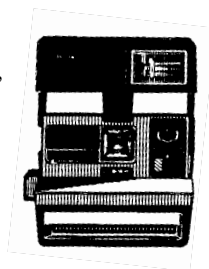

Item # M77776
U/M - Each

600 Instant Film :

- Works with all Polaroid instant cameras
- 10 photos per pack
- Sold per pack only

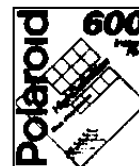

Item # M77777
U/M - Pack



MILL SUPPLY CO., INC.

Phone (410) 485-3343
Fax (410) 325-2240

Toll Free 1-800-817-8183

Industrial

FLASHLIGHTS



Industrial Flashlight :

- #1 Selling Industrial Flashlight
- Toolbox tough. Barrier wall and shock-absorbing spring protected bulb
- Prismatic reflector and Krypton bulbs for bright, white working spot.
- Polypropylene construction resists impact, chemicals, oil, grease, water, and corrosion.
- Full lifetime warranty
- Uses 2ea "D" batteries # (M19103) not included

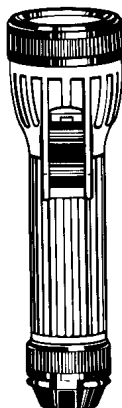

Replacement bulb for # M17768 Flashlight
Item # M17786
 U/M - Pack



Item # M17768
 U/M - Each

Industrial Swivel-Lite Flashlight :

- Toolbox tough
- Contractor grade construction
- Sure-grip rubber handle
- Rubber end caps for extra durability
- Swivel head puts light where you need it
- Uses 2ea "D" batteries included

90° Swivel Head

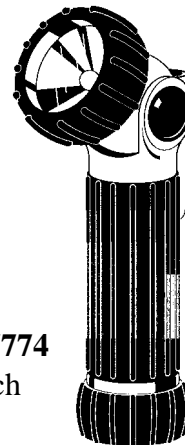

Item # M17774
 U/M - Each

Replacement bulb for # M17774 Flashlight
Item # M17786
 U/M - Pack



Floating Lantern :

- Safety glow lens ring- glows in the dark
- Weather resistant
- Long range beam
- Made in the U.S.A.
- Battery not included
- Uses 1ea Battery # (M17525) HD or (M17519) GP



Item # M17757
 U/M - Each

Replacement bulb for # M17757 Flashlight
Item # M17816
 U/M - Pack



Utility Lantern :

- Sealed beam utility lantern with # (M17513) GP battery

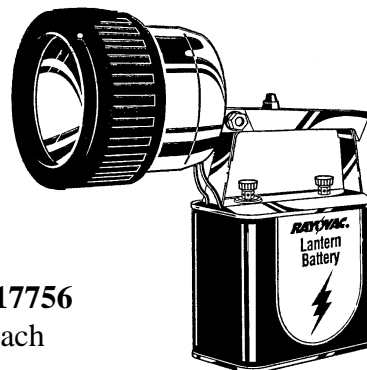

Item # M17756
 U/M - Each

Replacement bulb for # M17756 Lantern
Item # M17779
 U/M - Each



MILL SUPPLY CO., INC.

Phone (410) 485-3343
 Fax (410) 325-2240

Toll Free 1-800-817-8183

Industrial

GENERATORS



2,900W Generator :

- Economy type generator
- Powered by Mitsubishi OHV engine
- Brushless design alternator
- Built-in sensor and no fuse breaker
- See below for specifications

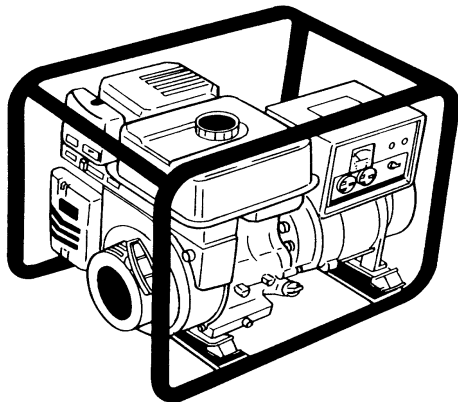

Item # M12521
U/M - Each

4,000W Generator :

- Deluxe type generator with full front panel
- Powered by Mitsubishi OHV engine with large air cleaner and muffler
- Large fuel tank for extended operation with fuel gauge
- Built-in oil sensor, no fuse breaker and volt meter
- See below for specifications

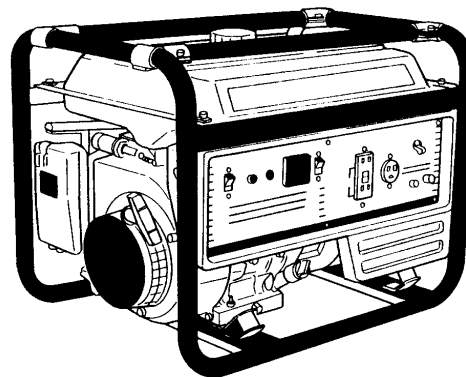

Item # M12536
U/M - Each

		Item # M12521	Item # M12536
G E N E R A T O R	Voltage Regulation	Condenser load Compensation	AVR
	Frequency	60Hz	60Hz
	Maximum Output	2,900W	4,000W
	Rated Output AC	2,500	3,300
	Rated Output DC	N/A	N/A
	Rated Voltage AC	120 (20.8A)	100 (8.3A)
	Rated Voltage DC	N/A	120/240 (27.5A/13.8A)
	Power Factor	100%	100%
E N G I N E	Model	GM181	GM291
	Engine Type	6.0HP, Air-cooled, 4-cycle OHV gasoline engine w/inclined cylinder	8.0HP, Air-cooled, 4-cycle OHV gasoline engine w/inclined cylinder
	Displacement	181ml	296ml
	Fuel	Regular automobile gasoline	Regular automobile gasoline
	Fuel Tank Capacity	1.06gal	5.2gal
	Cont. Operating Hours	2.3	8.5
	Lubricating Oil	Engine oil SD class or higher, 10W-30	Engine oil SD class or higher, 10W-30
Lub. Oil Volume	.63qts	1.1qts	
Ignition System	Electronic ignition	Electronic ignition	
E Q U I P M E N T	Starting System	Recoil starter	Recoil starter
	Noise Level [7m] {db [A]}	70	68/71
	Length	22.5"	24.6"
	Width	16.7"	19.5"
	Height	16.9"	19.5"
	Dry Weight	95lbs	105lbs
	Volt Meter	Equipped	Equipped
	Oil Sensor / Lamp	Equipped	Equipped



MILL SUPPLY CO., INC.

Phone (410) 485-3343
Fax (410) 325-2240

Toll Free 1-800-817-8183

Safety Equipment

Safety Equipment

WILLSON®

3M

igloo®

KIDDE

FYRNETICS INC.

**EEB
SAFETY**

GLOVES, INC.

Champion
ERGONOMIC PRODUCTS

Aearo E-A-R®

BOSS



MILL SUPPLY CO., INC.

Phone (410) 485-3343
Fax (410) 325-2240

Toll Free 1-800-817-8183

Safety Equipment

SAFETY HELMENTS

Safety Helmets :

- 6 Point Nylon Suspension
- Certified to ANSI Z89.1, type I, Class C, E, & G requirements
- Certified when worn with the peak toward the back of the head

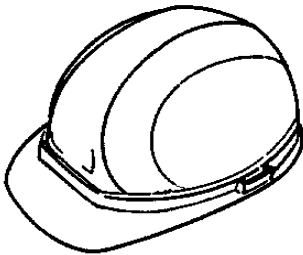

Item #	U/M	Color
M15153	Each	White
M15156	Each	Yellow

- Other colors available
- Contact your sales representative for details

Ratchet Safety Helmets :

- 6 Point Nylon Suspension
- Self Adjusting Knob to assure snug fit
- Certified to ANSI Z89.1, type I, Class C, E, & G requirements
- Certified when worn with the peak toward the back of the head

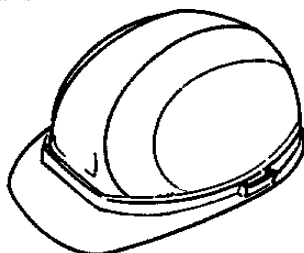

Item #	U/M	Color
M15162	Each	White
M15163	Each	Orange
M15165	Each	Yellow
M15168	Each	Red
M15171	Each	Green

- Other colors available
- Contact your sales representative for details.

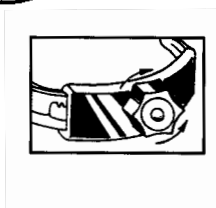

Bump Caps :

- Molded from high density polyethylene
- Fully cushioned brow pad absorbs moisture
- Brow pad is removable, washable, and replaceable
- Perforated sides allow cross ventilation for maxium air circulation
- Color (White)

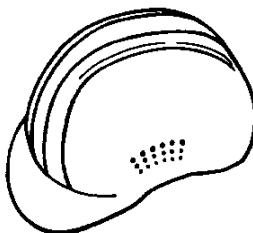

Item # M15172
U/M - Each

- * **Bump Caps are not designed to protect against impact from falling or glancing objects**
- * **Does not meet ANSI Z89.1 requirements**

Head Protection Accessories

Sweat Band :

- Highly absorbant cellulose
- Reusable

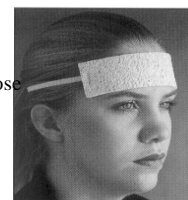

Item # M15509
U/M - Each

Chin Strap :

- Fits both our ratchet and non-ratchet hard hats
- Soft cotton elastic
- Extra control in windy conditions

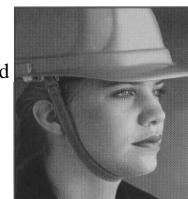

Item # M15159
U/M - Each

Winter Liners :

- Extra protection for cold days
- Available in plain - quilted (pictured) and bomber style - also quilted (not pictured)
- Bomber style has velcro strap under chin and greater neck protection



Item # M15176
U/M - Each
Quilted

Item # M15177
U/M - Each
Bomber



MILL SUPPLY CO., INC.

Phone (410) 485-3343
Fax (410) 325-2240

Toll Free 1-800-817-8183

Safety Equipment

EYE PROTECTION

Ratchet Face Shield :

- Secure-Fit ratchet sizing adjustment
- Resilient cam-lock features easily hold the face shield in place.
- Tension can be adjusted for any fixed or moveable window position.
- Polycarbonate shield
- Meets ANSI Z87.1

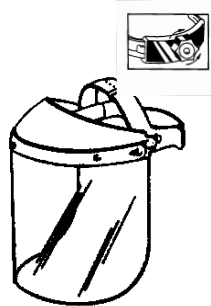

Replacement Window
for Face Shield - Clear
Item # M15256
U/M - Each

Item # M15253
U/M - Each

Perforated Goggle :

- Multi-purpose ultra soft goggle with clear polycarbonate lens
- Flexible vinyl frame provides excellent facial fit
- Perforated to allow comfortable ventilation
- For environments where chemical splashes and irritating fumes are not primary hazards
- Meets ANSI Z87.1

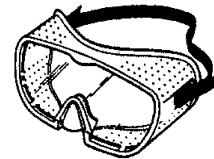

Item # M15240
U/M - Each

Visitor / Utility Spectacle :

- Provides an economical alternative for short term eye protection
- Can be worn alone or over prescription glasses
- Polycarbonate lens is optically correct and offers UV protection
- Meets ANSI Z87.1



Item # M15250
U/M - Each

Millennias :

WILLSON®

- Perfect fit and comfort
- Superior optical qualities and complete protection
- 180 degree clarity of view without distortion
- Adjustable, break-away retainer for added security and convenience for an active work environment
- Meets ANSI Z87.1

Lanyard
Included

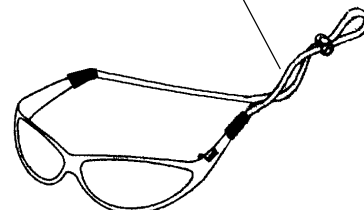

Item #	U/M	Frame	Lens
M15225	Each	Black	Clear
M15226	Each	Black	Smoke
M15227	Each	Black	Amber



MILL SUPPLY CO., INC.

Phone (410) 485-3343
Fax (410) 325-2240

Toll Free 1-800-817-8183

Safety Equipment

HEARING, NECK & BACK PROTECTION

Ear Muff :

- Lightweight hearing protector
- Economical choice for hearing protection
- Soft vinyl ear cushions
- Individually adjustable ear cups
- Meets ANSI S3.19
- NRR 20



Item # M15317
U/M - Each

E-A-R Classic Ear Plugs :

- Unique soft PVC foam provides a custom fit
- Cylindrical shape allows easy insertion and provides equal pressure throughout ear canal
- Plugs are washable and reusable
- Moisture resistant, will not swell
- Packed in reusable pillow pack (2 plugs / Pack)
- Sold per box only (200 packs / Box)
- NRR 29

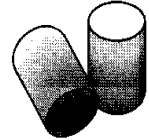

Item # M15301
U/M - Box

Corded Airsoft Ear Plugs :

- Molded, reusable earplug
- Unique air pocket to increase noise reduction
- Ribbed design for a secure fit
- Bright blue with red cord
- Packed in reusable plastic pack
- Sold per Each
- NRR 27

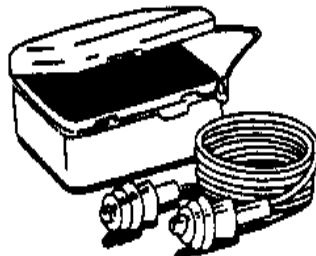

Item # M15309
U/M - Each

Cool Cat Collar :

- Reusable
- Prevents dehydration by reducing sweating
- Will keep you cool all day
- Use as a heat pack to relieve sore muscles
- Use as a cold pack to relieve headaches and fevers



Item # M15503
U/M - Each

Koolback Back Support Belt :

- Cooler for the wearer due to the lightweight polyester mesh construction
- Patented "Tapered Design" reduces "Ride-Up" for increased comfort and fit
- Reduces lower back fatigue by providing abdominal lift
- Provides lower back support
- 90 day warranty
- Color : Safety Orange



Item #	U/M	Size	Waist Size
M15023	Each	Small	21"-27"
M15026	Each	Medium	28"-34"
M15029	Each	Large	35"-41"
M15032	Each	X-Large	42"-48"
M15035	Each	2X	49"-55"
M15038	Each	3X	56"-62"



MILL SUPPLY CO., INC.

Phone (410) 485-3343
Fax (410) 325-2240

Toll Free 1-800-817-8183

Safety Equipment

RESPIRATORY PROTECTION

Disposable Non-Toxic Dust & Filter Mask #8500 :

- 100% Polypropylene
- Uses include:
Planting, harvesting, weeding,
cleaning garages, basements,
farm buildings, sanding wood
walls, machinery, gardening,
mowing, working with fiberglass,
working with cement
- Sold in boxes of 50 masks

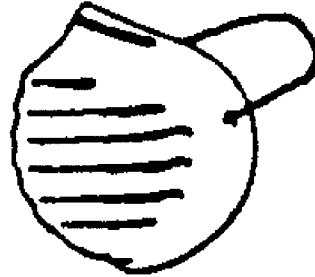

3M



Item # M15109
U/M - Box

N95 Particulate Respirator #8210 :

- The 8210 is designed for applications where few or no adverse conditions (high heat, humidity, sparks, etc.) are present and/or the respirator will be worn for a short period of time. The 8210 is for customers who want basic, economical protection. Meets NIOSH 42 CFR 84 standard.
- Sold in boxes of 20 masks

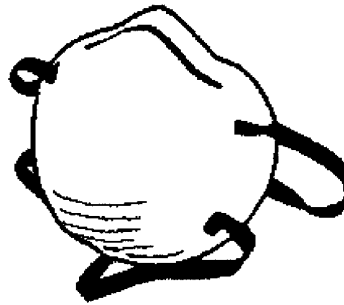

3M



Item # M15103
U/M - Box

Half Mask Respirator #52P71:

- Recommended for paint & oil free pesticides
- Replaceable cartridges and filters
- NIOSH approved
- Meets OSHA requirements

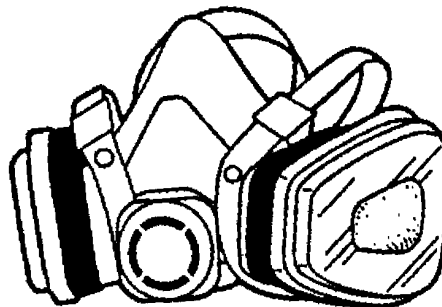

3M



Item # M15118
U/M - Each



MILL SUPPLY CO., INC.

Phone (410) 485-3343
Fax (410) 325-2240

Toll Free 1-800-817-8183

Safety Equipment

GLOVES

* All gloves are size mens large unless otherwise noted.

Brown Jersey :

- Clute cut
- Knit wrist



Item # M16048
U/M - Pair

Brown Jersey Lined :

- Slip-on style
- Gunn cut
- Red jersey lining



Item # M16051
U/M - Pair

Orange Jersey :

- Clute cut
- Knit wrist

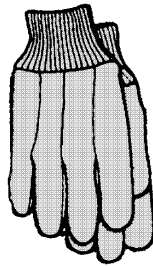

Item # M16053
U/M - Pair

String Knit Glove :

- Cotton blend
- Reversible
- Ribbed knit wrist
- White

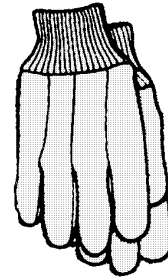

Item # M16117
U/M - Pair

Split Leather Welder :

- Fully lined grey split leather
- Gunn cut
- One piece back

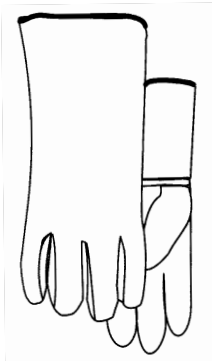

Item # M16078
U/M - Pair

Leather Fleece Lined :

- Therma-Tek gloves utilize the heat generated by working hands
- The inside layer of soft, brushed polyester fabric wicks away moisture and the outside layer of air-trapping cells creates an insulating barrier against the cold

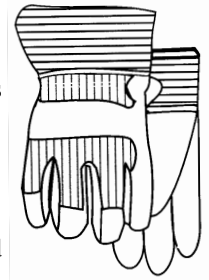

Item # M16081
U/M - Pair



MILL SUPPLY CO., INC.

Phone (410) 485-3343
Fax (410) 325-2240

Toll Free 1-800-817-8183

Safety Equipment

* All gloves are size mens large unless otherwise noted.

GLOVES

Leather Palm Knit Wrist :

- Split leather palm, clute cut
- Striped cotton back
- Continuous thumb
- Knit wrist

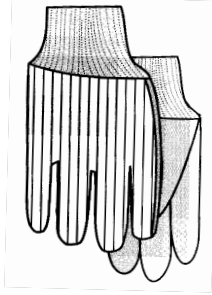

Item # M16085
U/M - Pair

Leather Palm Economy :

- Split leather palm, gunn cut
- Striped cotton back
- Palm patch, leather index finger
- Leather tips, leather knuckle strap and pull
- Wing thumb, safety cuff

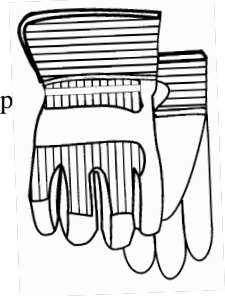

Item # M16090
U/M - Pair

Leather Palm :



- Split leather palm, gunn cut
- Striped cotton back
- Shirred elastic back
- Leather tips, leather index finger and pull
- Wing thumb, rubberized safety cuff
- Leather knuckle strap and pull



Item # M16082
U/M - Pair

Leather Double Palm :



- Shoulder leather
- Striped back
- 2-1/2" waterproof safety cuff
- Heavy duty reinforced leather patch covering palm, thumb, index finger and little finger

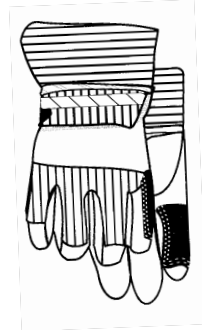

Item # M16093
U/M - Pair

Leather Driver :

- Grain leather
- Gunn cut
- Keystone thumb
- Shirred elastic back
- Superior grip

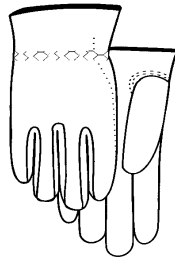

Item # M16083
U/M - Pair
Size: Large

Item # M16084
U/M - Pair
Size: X-Large

Leather Driver Lined :

- Top grain leather
- Gunn cut
- Keystone thumb
- Shirred elastic back
- Fleece lined for warmth
- Superior grip

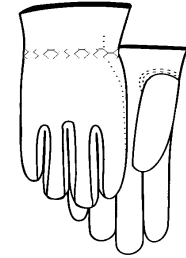

Item # M16108
U/M - Pair



MILL SUPPLY CO., INC.

Phone (410) 485-3343
Fax (410) 325-2240

Toll Free 1-800-817-8183

Safety Equipment

GLOVES

* All gloves are size mens large unless otherwise noted.

Blue Nitrile Knit Wrist :

- Lightweight blue nitrile rubber
- 2-piece jersey liner
- Rough grip
- Fully coated
- Outwears PVC and leather palm gloves

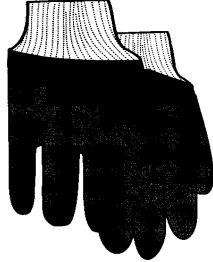

Item # M16063
U/M - Pair

Blue Nitrile Heavyweight :

- Heavyweight blue nitrile rubber
- 2-piece jersey liner
- Rough grip
- Partially coated
- Safety cuff
- Outwears PVC and leather palm gloves

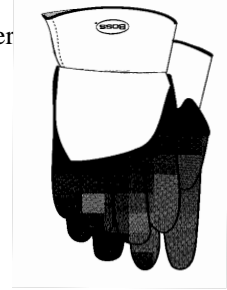

Item # M16060
U/M - Pair

Blue Nitrile Gauntlet Cuff :

- Fully coated blue nitrile rubber
- Gauntlet cuff 14" long
- Rough grip
- Outwears PVC and leather palm gloves

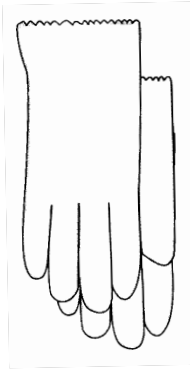

Item # M16057
U/M - Pair

Powdered Latex Disposable :

- Rolled cuff
- 5 mil.
- Hypoallergenic
- 9-1/2" long
- Sold in dispenser box only
- 100 gloves / box

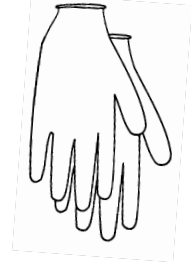

Item #	U/M	Size
M16066	Box	Small
M16069	Box	Medium
M16072	Box	Large
M16075	Box	X-Large

PVC Knit Wrist :

- Single dipped fully coated black PVC
- Interlock lined
- Rough Grip
- Excellent for handling of equipment and abrasive material coated with oils or solvents

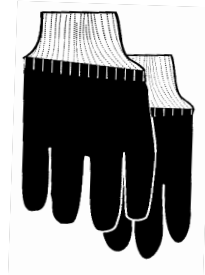

Item # M16113
U/M - Pair

PVC Foam Lined :

- Fully coated fluorescent orange PVC
- Foam insulated
- Rough grip
- Maximum abrasion resistance

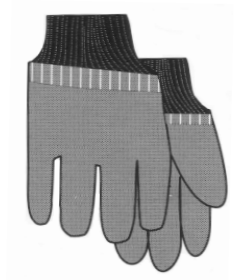

Item # M16021
U/M - Pair



MILL SUPPLY CO., INC.

Phone (410) 485-3343
Fax (410) 325-2240

Toll Free 1-800-817-8183

Safety Equipment

* All gloves are size mens large unless otherwise noted.

GLOVES

PVC Gauntlet Cuff :

- Single dipped fully coated black PVC
- Interlock lined
- Rough grip
- Durable and economical general purpose work glove

Item # M16115
U/M - Pair



Unlined Black Latex :

- 30 gauge, 12" long
- Diamond grip
- Flock lined
- Chlorinated

Item # M16042
U/M - Pair
Size: Large

Item # M16043
U/M - Pair
Size: X-Large



Unlined Black Latex :

- 35 gauge, 12" long
- Rough grip
- Rolled cuff
- Crinkle finish provides maximum gripping power

Item # M160
U/M - Pair



Ladies Latex Light Duty :

- Flock lining
- Non-slip grip
- Ideal for cleaning, scrubbing, washing dishes, gardening
- Yellow
- Sized for Ladies



Item #	U/M	Size
M16024	Pair	7
M16027	Pair	8
M16030	Pair	9
M16033	Pair	10

Glove Reference Guide

Key to Chart:

- E Excellent
- G Good
- F Fair
- P Poor

PHYSICAL PROPERTIES	NITRILE	NATURAL RUBBER	PVC	NEOPRENE
Abrasion Resistance	E	G	G	G
Cut Resistance	E	E	P	E
Puncture (snag) Resistance	E	E	G	E
Flexibility	E	E	G	G
Heat Resistance	G	F	P	G
Ozone Resistance	F	P	E	E
Tensile Strength	E	E	F	E
Dry Grip	E	E	E	E
Wet Grip	G	E	E	F

This chart is for reference purposes only. For specific applications and chemical resistance data, contact your sales representative.



MILL SUPPLY CO., INC.

Phone (410) 485-3343
Fax (410) 325-2240

Toll Free 1-800-817-8183

Safety Equipment

RAINWEAR

3 Piece Rain Suit :

- 35 mil Supported PVC on Polyester
- Jacket w/detachable hood
- Straight PVC collar
- Storm fly front
- Raglan sleeves
- Take-up snaps at cuff
- 2 patch pockets with flap
- Bib overall w/snap-fly front
- Adjustable elastic suspenders w/plastic buckles
- Noncorrosive and nonconductive plastic snaps
- Take-up snaps at ankles
- Sizes listed are mens
- Yellow

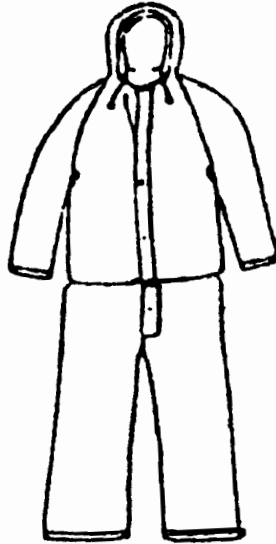

Item #	U/M	Size
M16250	Each	Small
M16253	Each	Medium
M16256	Each	Large
M16259	Each	X-Large
M16262	Each	2X
M16265	Each	3X

Coat :

- 35 mil Supported PVC on Polyester
- Jacket w/detachable hood
- 48" long
- Cape back
- Raglan sleeves
- Storm fly front
- Noncorrosive and nonconductive plastic snaps
- Sizes are mens
- Yellow

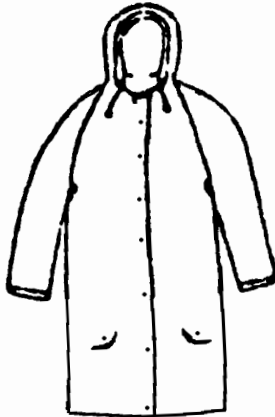

Item #	U/M	Size
M16272	Each	Small
M16275	Each	Medium
M16278	Each	Large
M16281	Each	X-Large
M16285	Each	2X
M16289	Each	3X

Over The Shoe Boots :

- 17" tall, fabric lining
- Top strap and buckle
- Bar tread outsole
- Sizes are mens
- Yellow



Item #	U/M	Size
M16202	Pair	9
M16203	Pair	10
M16206	Pair	11
M16209	Pair	12
M16212	Pair	13
M16213	Pair	14



MILL SUPPLY CO., INC.

Phone (410) 485-3343
Fax (410) 325-2240

Toll Free 1-800-817-8183

Safety Equipment

BOOTS, VESTS, FLAGS, & SIGNAGE

PVC Knee Boots :

- Washable nylon lining
- Bar tread outsole
- Steel toe
- Sized in mens
- Color (Black)



Item #	U/M	Size
M15853	Pair	8
M15856	Pair	9
M15859	Pair	10
M15862	Pair	11
M15865	Pair	12

Safety Flag :

- 18" x 18" Nylon mesh
- 24" staff
- Highly visible
- Color (Safety Orange)

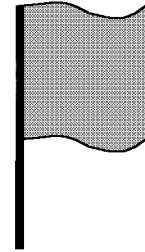

Item # M15687
U/M - Each

Safety Vest :

- Lightweight, highly visible nylon mesh
- Adjustable front closure with hook and loop material
- Durable elastic side straps
- Color (Safety Orange)

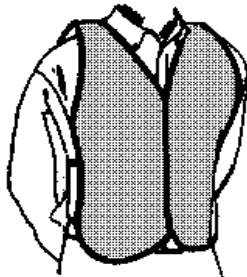

Item # M15693
U/M - Each

Safety Vest w/Reflective Stripe :

- Lightweight, highly visible nylon mesh
- Adjustable front closure with hook and loop material
- Durable elastic side straps
- Bright yellow reflective stripes
- Color (Safety Orange)



Item # M15690
U/M - Each

Sign Post :

- Green
- 10' length
- "U" Channel type
- 3/8" holes
- Made of high tensile steel

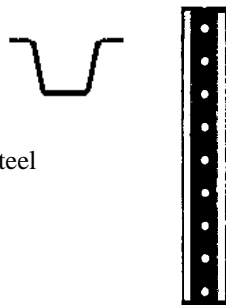

Item # M15725
U/M - Each

Signage :

- "Caution Hard Hat Area"
- 10" x 14"
- Highly visible
- Color (Yellow & Black)
- "No Trespassing"
- 9" x 12"
- Highly visible
- Color (Black & Red)



Item # M15706
U/M - Each



Item # M15705
U/M - Each



MILL SUPPLY CO., INC.

Phone (410) 485-3343
Fax (410) 325-2240

Toll Free 1-800-817-8183

Safety Equipment

FIRST AID KITS

First Aid Kits :

- Metal Box
- Flip up wall mounting brackets
- Vinyl gasket provides a positive, dust and moisture resistant seal
- Metal handle for easy transportation



25 Person Kit Contains:

- 50 Adhesive Strips
- 1 Adhesive Tape Roll
- 3 Ammonia Inhalants
- 12 Aspirin
- 1 Cold Pack
- 1 Combine Dressing
- 1 Cotton 1/2oz
- 1 First Aid Cream
- 1 Gauze Bandage
- 10 Gauze Pads
- 2 Gloves
- 1 Scissors
- 1 Triangular Bandage
- 1 Tweezers
- 10 Wound Wipes
- 1 Instructions

Item # M15603
U/M - Each

50 Person Kit Contains:

- 50 Adhesive Bandages 3/4"x3"
- 50 Adhesive Bandages 1"x3"
- 4 Adhesive Bandages 2"
- 6 Fingertip Bandages
- 6 Knuckle Bandages
- 2 Gauze Bandage 2"x5 yd.
- 2 Gauze Bandage 3"x5 yd.
- 4 Gauze Pads 2"x2"
- 7 Gauze Pads 3"x3"
- 2 Non-Adherent Pads 3"x4"
- 2 Abdominal/Pressure Pad 5"x9"
- 1 Elastic Bandage 3" w/clips
- 1 Triangular Bandage w/pins 40"
- 1 Eye Cleaning Solution 1oz
- 2 Adhesive Tape 1/2"x2-1/2 yrd
- 10 Antibacterial Wound Wipes

Item # M15606
U/M - Each

Adhesive Bandages :

- 1" x 3"
- Individually wrapped
- Sterile Non-stick pad
- Sold in box of 100/ea

Item # M15612
U/M - Box



Bloodborne Kit :

- Complies with OSHA CFR 1910.1030
- Packed in heavy duty plastic case with mounted handle and safety latch system
- Includes all personal protection equipment and clean-up material

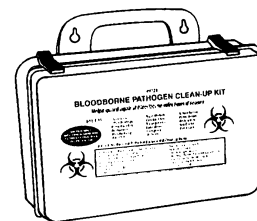

Item # M15623
U/M - Each



MILL SUPPLY CO., INC.

Phone (410) 485-3343
Fax (410) 325-2240

Toll Free 1-800-817-8183

Safety Equipment

WATERCOOLERS

igloo®

Industrial Water Coolers :

- Rugged, durable Igloo Industrial Water Coolers keep water cold, clean and available
- Takes the abuse of the roughest job site and the most punishing work crews
- Red & Yellow highly visible safety colors
- HDPE hide won't peel, chip, buckle or rust
- Ultraviolet stabilizers prevent fading, cracking, in all exposures
- White FDA Grade inner liners are easy to clean and resist stains and odors
- Reinforced handles and dispenser bracket
- 5 year warranty

Item # M12252
U/M - Each
2 Gallon



Item # M12256
U/M - Each
5 Gallon



Item # M12258
U/M - Each
10 Gallon

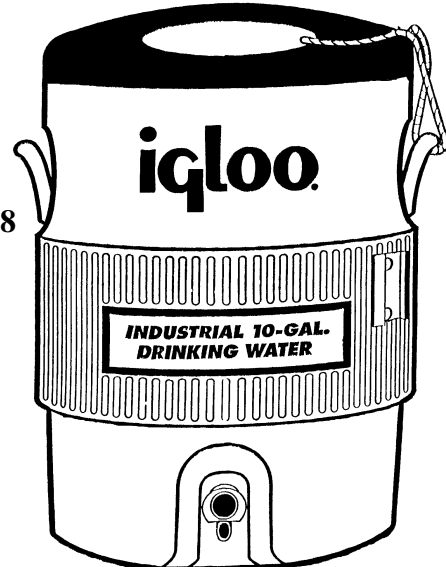

Water cooler Accessories

Metal Cup Dispenser :

- Fits Igloo 5 & 10 gallon coolers.
- Attaches easily to side of cooler



Item # M12275
U/M - Each

Drinking Cups :

- 4oz Cups
- "No leak" construction
- 5,000 cups per case



Item # M12284
U/M - Case



MILL SUPPLY CO., INC.

Phone (410) 485-3343
Fax (410) 325-2240

Toll Free 1-800-817-8183

Safety Equipment

FIRE EXTINGUISHERS & CABINETS

KIDDE

2-1/2 lb Fire Extinguisher :

- A B C Class
- Reliable gauge for fast and easy pressure checks
- Seamless aluminum and steel cylinders have chip-resistant epoxy finish
- Rechargeable unit is easy to service
- 6 year warranty



Item # M77012
U/M - Each



5 lb Fire Extinguisher :

- A B C Class
- Reliable gauge for fast and easy pressure checks
- Seamless aluminum and steel cylinders have chip-resistant epoxy finish
- Rechargeable unit is easy to service
- 6 year warranty



Item # M77015
U/M - Each



10 lb Fire Extinguisher :

- A B C Class
- Reliable gauge for fast and easy pressure checks
- Seamless aluminum and steel cylinders have chip-resistant epoxy finish
- Rechargeable unit is easy to service
- 6 year warranty



Item # M77018
U/M - Each



Fire Extinguisher Cabinets :

- Galvanized steel for rust resistance
- Bright white fused finish
- Surface mounted
- Tempered glass for safety
- Can be locked with standard padlock - **not included**

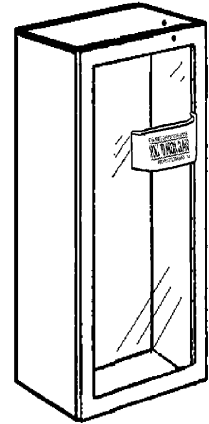

Item # M77040 Item # M77041
U/M - Each U/M - Each
2-1/2-5lb Extinguisher Cabinet 10lb Extinguisher Cabinet

Extinguisher Cabinet Accessories

Item Description	2-1/2-5lb Cabinet	10lb Cabinet
Rep. Tempered Glass	M77034	M77035
Rep. Break Handle	M77049	M77049
Master #7 Padlock KD	M14139	M14139
Master #7 Padlock KA	M14140	M14140
Import Padlock KD	M14239	M14239
Import Padlock KA	M14240	M14240



MILL SUPPLY CO., INC.

Phone (410) 485-3343
Fax (410) 325-2240

Toll Free 1-800-817-8183

Safety Equipment

Safety Equipment

SMOKE DETECTORS



Battery Powered Smoke Alarm :

- Loud, piercing, pulsating horn alerts you quickly at 85 decibels
- Low battery indicator will "chirp" when battery life becomes low
- Tamper-proof locking pin to deter theft
- Special twist-off mounting bracket makes installation easy and battery replacement safe
- 9 volt battery included

Test Button.
Tests smoke alarm circuitry and horn.

Flashing Red Light.
Red LED light located under test button flashes every 30-40 seconds to indicate that the smoke alarm is receiving power.

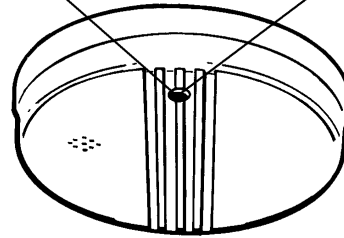

Item # M77054
U/M - Each

120V AC Wire-In Smoke Alarm :

- Loud, piercing, pulsating horn alerts you quickly at 85 decibels
- Single or multi-station capability allows up to 24 units to be linked together
When one alarm sounds, all innerconnected alarms will sound
- Tamper-proof locking pin to deter theft
- Quick-disconnect AC connection
- Separate trim ring fits all standard electrical box configurations

Alarm Light (red).
Rapid flashing LED light indicates which unit in the multi-station installation is the originating alarm.

Test Button.
Tests smoke alarm circuitry and horn.

AC Power Light (green).
When on, indicates 120 Volt AC power is being delivered to smoke alarm.

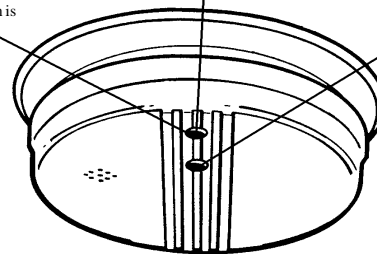

Item # M77058
U/M - Each

Smoke Detector Tester :

- Institutional size 2.5oz.
- Contains no ozone depleting chemicals



Item # M77121
U/M - Each

120V AC Wire-In Smoke Alarm w/9 Volt Battery Back Up :

- Loud, piercing, pulsating horn alerts you quickly at 85 decibels
- Single or multi-station capability allows up to 24 units to be linked together
When one alarm sounds, all innerconnected alarms will sound
- Tamper-proof locking pin to deter theft
- Quick-disconnect AC connection
- Separate trim ring fits all standard electrical box configurations
- Low battery indicator will "chirp" when battery life becomes low

Alarm Light (red).
Rapid flashing LED light indicates which unit in the multi-station installation is the originating alarm.

Test Button.
Tests smoke alarm circuitry and horn.

AC Power Light (green).
When on, indicates 120 Volt AC power is being delivered to smoke alarm.

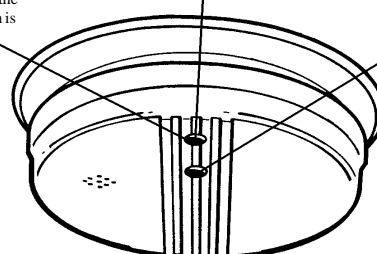

Item # M77062
U/M - Each



9Volt Battery Included



MILL SUPPLY CO., INC.

Phone (410) 485-3343
Fax (410) 325-2240

Toll Free 1-800-817-8183

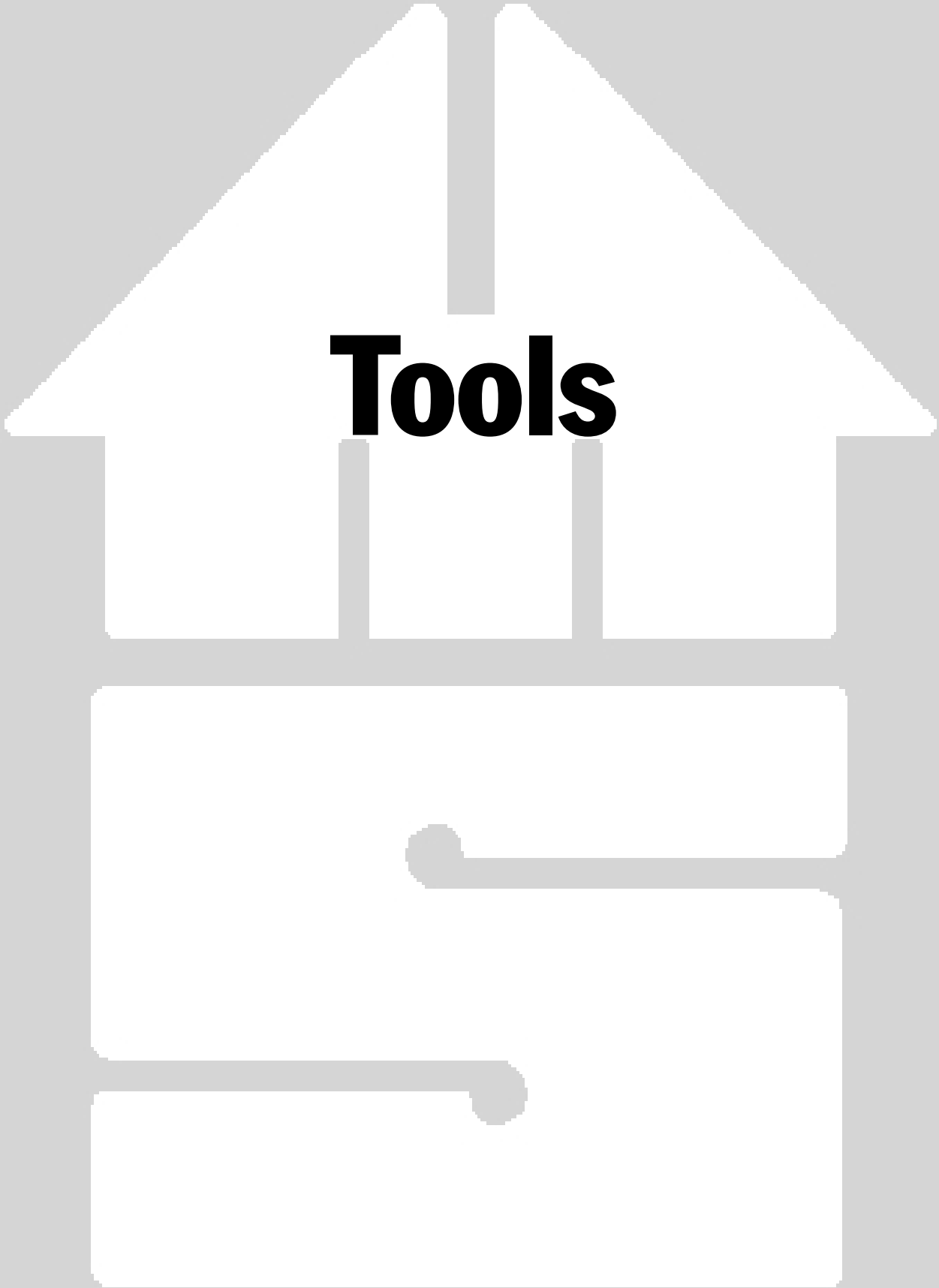

Tools

MORSE

STANLEY

Nicholson[®]

DEWALT[®]

Red Devil [®]

Wiss[®]

Crescent[®]

RIDGID[®]

GOLDBLATT[®]

UnionTools[®]
Quality You Can Count On

Lufkin[®]

WISE GRIP[®]



MILL SUPPLY CO., INC.

Phone (410) 485-3343
Fax (410) 325-2240

Toll Free 1-800-817-8183

Tools

BORING TOOLS

High Speed Steel

Jobber Length Drill Bits :

- General purpose jobber bit
- Sold per each
- Fractional Size



Item #	U/M	Size	Decimal	Flute Length	Overall Length	Quantity Per Pack
M29558	Each	1/32"	.0312	1/2"	1-3/8"	12
M29560	Each	3/64"	.0469	3/4"	1-3/4"	12
M29561	Each	1/16"	.0625	7/8"	1-7/8"	12
M29563	Each	5/64"	.0781	1-3/4"	2"	12
M29565	Each	3/32"	.0938	1-1/4"	2-1/4"	12
M29567	Each	7/64"	.1094	1-1/2"	2-5/8"	12
M29569	Each	1/8"	.1250	1-5/8"	2-3/4"	12
M29571	Each	9/64"	.1406	1-3/4"	2-7/8"	12
M29573	Each	5/32"	.1562	2"	3-1/8"	12
M29575	Each	11/64"	.1719	2-1/8"	3-1/4"	12
M29577	Each	3/16"	.1875	2-5/16"	3-1/2"	12
M29579	Each	13/64"	.2031	2-7/16"	3-5/8"	12
M29581	Each	7/32"	.2188	2-1/2"	3-3/4"	12
M29583	Each	15/64"	.2344	2-5/8"	3-7/8"	12
M29585	Each	1/4"	.2500	2-3/4"	4"	12
M29586	Each	17/64"	.2656	2-7/8"	4-1/8"	12
M29587	Each	9/32"	.2812	2-15/16"	4-1/4"	6
M29589	Each	19/64"	.2969	3-1/16"	4-3/8"	6
M29591	Each	5/16"	.3125	3-3/16"	4-1/2"	6
M29593	Each	21/64"	.3281	3-5/16"	4-5/8"	6
M29595	Each	11/32"	.3438	3-7/16"	4-3/4"	6
M29597	Each	23/64"	.3594	3-1/2"	4-7/8"	6
M29599	Each	3/8"	.3750	3-5/8"	5"	6
M29601	Each	25/64"	.3906	3-3/4"	5-1/8"	6
M29603	Each	13/32"	.4062	3-7/8"	5-1/4"	6
M29605	Each	27/64"	.4219	3-15/16"	5-3/8"	6
M29607	Each	7/16"	.4375	4-1/16"	5-1/2"	6
M29609	Each	29/64"	.4531	4-3/16"	5-5/8"	6
M29611	Each	15/32"	.4688	4-5/16"	5-3/4"	6
M29613	Each	31/64"	.4844	4-3/8"	5-7/8"	6
M29615	Each	1/2"	.5000	4-1/2"	6"	6



MILL SUPPLY CO., INC.

Phone (410) 485-3343
Fax (410) 325-2240

Toll Free 1-800-817-8183

Tools

BORING TOOLS

High Speed Steel Jobber Length Drill Bits :

- General purpose jobber bit
- Sold per each
- Wire Gauge Size



Item #	U/M	Size	Decimal	Flute Length	Overall Length	Quantity Per Pack
M29301	Each	1	.2280	2-5/8"	3-7/8"	12
M29302	Each	2	.2210	2-5/8"	3-7/8"	12
M29303	Each	3	.2130	2-1/2"	3-3/4"	12
M29304	Each	4	.2090	2-1/2"	3-3/4"	12
M29305	Each	5	.2055	2-1/2"	3-3/4"	12
M29306	Each	6	.2040	2-1/2"	3-3/4"	12
M29307	Each	7	.2010	2-7/16"	3-5/8"	12
M29308	Each	8	.1990	2-7/16"	3-5/8"	12
M29309	Each	9	.1960	2-7/16"	3-5/8"	12
M29310	Each	10	.1935	2-7/16"	3-5/8"	12
M29311	Each	11	.1910	2-5/16"	3-1/2"	12
M29312	Each	12	.1890	2-5/16"	3-1/2"	12
M29313	Each	13	.1850	2-5/16"	3-1/2"	12
M29314	Each	14	.1820	2-3/16"	3-3/8"	12
M29315	Each	15	.1800	2-3/16"	3-3/8"	12
M29316	Each	16	.1770	2-3/16"	3-3/8"	12
M29317	Each	17	.1730	2-3/16"	3-3/8"	12
M29318	Each	18	.1695	2-1/8"	3-1/4"	12
M29319	Each	19	.1660	2-1/8"	3-1/4"	12
M29320	Each	20	.1610	2-1/8"	3-1/4"	12
M29321	Each	21	.1590	2-1/8"	3-1/4"	12
M29322	Each	22	.1570	2"	3-1/8"	12
M29323	Each	23	.1540	2"	3-1/8"	12
M29324	Each	24	.1520	2"	3-1/8"	12
M29325	Each	25	.1495	1-7/8"	3"	12
M29326	Each	26	.1470	1-7/8"	3"	12
M29327	Each	27	.1440	1-7/8"	3"	12
M29328	Each	28	.1405	1-3/4"	2-7/8"	12
M29329	Each	29	.1360	1-3/4"	2-7/8"	12
M29330	Each	30	.1285	1-5/8"	2-3/4"	12
M29331	Each	31	.1200	1-5/8"	2-3/4"	12
M29332	Each	32	.1160	1-5/8"	2-3/4"	12
M29333	Each	33	.1130	1-1/2"	2-5/8"	12
M29334	Each	34	.1110	1-1/2"	2-5/8"	12
M29335	Each	35	.1100	1-1/2"	2-5/8"	12
M29336	Each	36	.1065	1-7/16"	2-1/2"	12
M29337	Each	37	.1040	1-7/16"	2-1/2"	12
M29338	Each	38	.1015	1-7/16"	2-1/2"	12
M29339	Each	39	.0995	1-3/8"	2-3/8"	12
M29340	Each	40	.0980	1-3/8"	2-3/8"	12



MILL SUPPLY CO., INC.

Phone (410) 485-3343
Fax (410) 325-2240

Toll Free 1-800-817-8183

Tools

BORING TOOLS

High Speed Steel

Jobber Length Drill Bits :

- General purpose jobber bit
- Sold per each
- Wire Gauge Size



Item #	U/M	Size	Decimal	Flute Length	Overall Length	Quantity Per Pack
M29341	Each	41	.0960	1-3/8"	2-3/8"	12
M29342	Each	42	.0935	1-1/4"	2-1/4"	12
M29343	Each	43	.0890	1-1/4"	2-1/4"	12
M29344	Each	44	.0860	1-1/8"	2-1/8"	12
M29345	Each	45	.0820	1-1/8"	2-1/8"	12
M29346	Each	46	.0810	1-1/8"	2-1/8"	12
M29347	Each	47	.0785	1"	2"	12
M29348	Each	48	.0760	1"	2"	12
M29349	Each	49	.0730	1"	2"	12
M29350	Each	50	.0700	1"	2"	12
M29351	Each	51	.0670	1"	2"	12
M29352	Each	52	.0635	7/8"	1-7/8"	12
M29353	Each	53	.0595	7/8"	1-7/8"	12
M29354	Each	54	.0550	7/8"	1-7/8"	12
M29355	Each	55	.0520	7/8"	1-7/8"	12
M29356	Each	56	.0465	3/4"	1-3/4"	12
M29357	Each	57	.0430	3/4"	1-3/4"	12
M29358	Each	58	.0420	11/16"	1-5/8"	12
M29359	Each	59	.0410	11/16"	1-5/8"	12
M29360	Each	60	.0400	11/16"	1-5/8"	12
M29361	Each	61	.0390	11/16"	1-5/8"	12
M29362	Each	62	.0380	5/8"	1-1/2"	12
M29363	Each	63	.0370	5/8"	1-1/2"	12
M29364	Each	64	.0360	5/8"	1-1/2"	12
M29365	Each	65	.0350	5/8"	1-1/2"	12
M29366	Each	66	.0330	1/2"	1-3/8"	12
M29367	Each	67	.0320	1/2"	1-3/8"	12
M29368	Each	68	.0310	1/2"	1-3/8"	12
M29369	Each	69	.0292	1/2"	1-3/8"	12
M29370	Each	70	.0280	3/8"	1-1/4"	12
M29371	Each	71	.0260	3/8"	1-1/4"	12
M29372	Each	72	.0250	5/16"	1-1/8"	12
M29373	Each	73	.0240	5/16"	1-1/8"	12
M29374	Each	74	.0225	1/4"	1"	12
M29375	Each	75	.0210	1/4"	1"	12
M29376	Each	76	.0200	3/16"	7/8"	12
M29377	Each	77	.0180	3/16"	7/8"	12
M29378	Each	78	.0160	3/16"	7/8"	12
M29379	Each	79	.0145	3/16"	3/4"	12
M29380	Each	80	.0135	3/16"	3/4"	12



MILL SUPPLY CO., INC.

Phone (410) 485-3343
Fax (410) 325-2240

Toll Free 1-800-817-8183

Tools

BORING TOOLS

High Speed Steel Jobber Length Drill Bits :

- General purpose jobber bit
- Sold per each
- Letter Size



Item #	U/M	Size	Decimal	Flute Length	Overall Length	Quantity Per Pack
M29430	Each	A	.2340	2-5/8"	3-7/8"	12
M29431	Each	B	.2380	2-3/4"	4"	12
M29432	Each	C	.2420	2-3/4"	4"	12
M29433	Each	D	.2460	2-3/4"	4"	12
M29434	Each	E	.2500	2-3/4"	4"	12
M29435	Each	F	.2570	2-7/8"	4"	12
M29436	Each	G	.2610	2-7/8"	4-1/8"	12
M29437	Each	H	.2660	2-7/8"	4-1/8"	12
M29438	Each	I	.2720	2-7/8"	4-1/8"	12
M29439	Each	J	.2770	2-7/8"	4-1/8"	12
M29440	Each	K	.2810	2-15/16"	4-1/4"	12
M29441	Each	L	.2900	2-15/16"	4-1/4"	12
M29442	Each	M	.2950	3-1/16"	4-3/8"	12
M29443	Each	N	.3020	3-1/16"	4-3/8"	6
M29444	Each	O	.3160	3-3/16"	4-1/2"	6
M29445	Each	P	.3230	3-5/16"	4-5/8"	6
M29446	Each	Q	.3320	3-7/16"	4-3/4"	6
M29447	Each	R	.3390	3-7/16"	4-3/4"	6
M29448	Each	S	.3480	3-1/2"	4-7/8"	6
M29449	Each	T	.3580	3-1/2"	4-7/8"	6
M29450	Each	U	.3680	3-5/8"	5"	6
M29451	Each	V	.3770	3-5/8"	5"	6
M29452	Each	W	.3860	3-3/4"	5-1/8"	6
M29453	Each	X	.3970	3-3/4"	5-1/8"	6
M29454	Each	Y	.4040	3-7/8"	5-1/4"	6
M29455	Each	Z	.4130	3-7/8"	5-1/4"	6



MILL SUPPLY CO., INC.

Phone (410) 485-3343
Fax (410) 325-2240

Toll Free 1-800-817-8183

Tools

Tools

BORING TOOLS

29 Piece High Speed Steel Jobber Length Drill Bit Set :

- With metal index
- 1/16" to 1/2" by 64ths

Item # M29213
U/M - Each

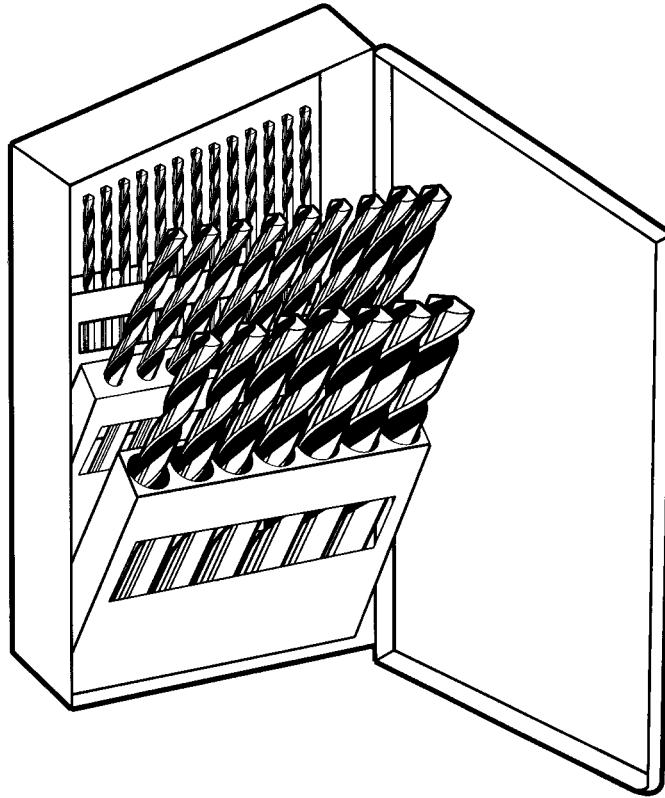

13 Piece High Speed Steel Jobber Length Drill Bit Set :

- With plastic storage case
- 1/16" to 1/4" by 64ths

Item # M29212
U/M - Each

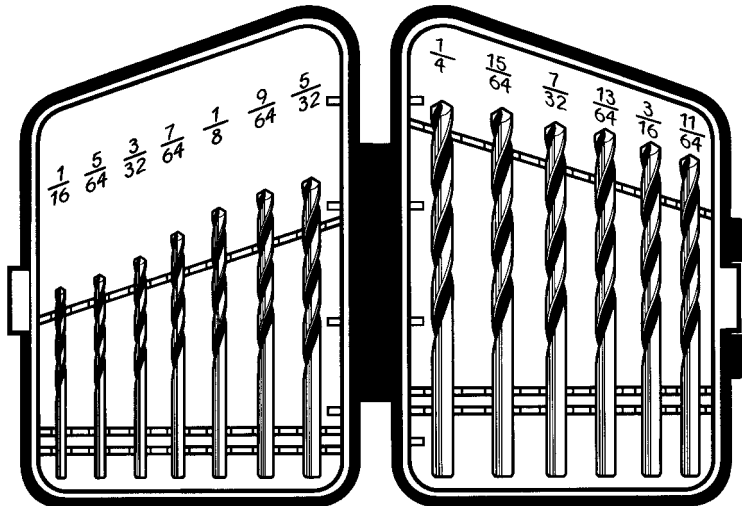

MILL SUPPLY CO., INC.

Phone (410) 485-3343
Fax (410) 325-2240

Toll Free 1-800-817-8183

Tools

BORING TOOLS

Paddle Bits :

- Wood Cutting Bit
- Sold per each
- 6" long steel



Item #	U/M	Size
M29182	Each	1/4"
M29183	Each	5/16"
M29184	Each	3/8"
M29185	Each	7/16"
M29186	Each	1/2"
M29187	Each	9/16"
M29188	Each	5/8"
M29189	Each	11/16"
M29190	Each	3/4"
M29191	Each	13/16"
M29192	Each	7/8"
M29193	Each	15/16"
M29194	Each	1"
M29195	Each	1-1/8"
M29196	Each	1-1/4"
M29197	Each	1-3/8"
M29198	Each	1-1/2"

Paddle Bit Sets

6 Piece Set :

- 6" long steel
- Sold per Pack
- 3/8", 1/2", 5/8", 3/4", 7/8", 1"
- With plastic holding sleeve

Item # M29199

U/M - Pack

13 Piece Set :

- 6" long steel
- Sold per Pack
- 1/4", 5/16", 3/8", 7/16", 1/2", 9/16", 5/8", 11/16", 3/4", 13/16", 7/8", 15/16", 1"
- With plastic holding sleeve

Item # M29200

U/M - Pack

Paddle Bit Extension :

- 1/4" hex w/1/4" round shank
- Sold per each
- 12" long steel
- 2 set screws hold bit securely
- Includes allen wrench



Item # M24793

U/M - Each



MILL SUPPLY CO., INC.

Phone (410) 485-3343
Fax (410) 325-2240

Toll Free 1-800-817-8183

Tools

BORING TOOLS

Cobalt Drill Bits :

- 135 degree split point
- Made of high speed cobalt steel
- High abrasion resistance
- Web construction adds to long life of these bits.
- Sold by each
- Fractional size



Item #	U/M	Size	Decimal	Flute Length	Overall Length	Quantity Per Pack
M29383	Each	1/64"	.0156	3/16"	3/4"	12
M29384	Each	1/32"	.0312	1/2"	1-3/8"	12
M29385	Each	3/64"	.0469	3/4"	1-3/4"	12
M29386	Each	1/16"	.0625	7/8"	1-7/8"	12
M29387	Each	5/64"	.0781	1-3/4"	2"	12
M29388	Each	3/32"	.0938	1-1/4"	2-1/4"	12
M29389	Each	7/64"	.1094	1-1/2"	2-5/8"	12
M29390	Each	1/8"	.1250	1-5/8"	2-3/4"	12
M29391	Each	9/64"	.1406	1-3/4"	2-7/8"	12
M29392	Each	5/32"	.1562	2"	3-1/8"	12
M29393	Each	11/64"	.1719	2-1/8"	3-1/4"	12
M29394	Each	3/16"	.1875	2-5/16"	3-1/2"	12
M29395	Each	13/64"	.2031	2-7/16"	3-5/8"	12
M29396	Each	7/32"	.2188	2-1/2"	3-3/4"	12
M29397	Each	15/64"	.2344	2-5/8"	3-7/8"	12
M29398	Each	1/4"	.2500	2-3/4"	4"	12
M29399	Each	17/64"	.2656	2-7/8"	4-1/8"	12
M29400	Each	9/32"	.2812	2-15/16"	4-1/4"	12
M29401	Each	19/64"	.2969	3-1/16"	4-3/8"	6
M29402	Each	5/16"	.3125	3-3/16"	4-1/2"	6
M29403	Each	21/64"	.3281	3-5/16"	4-5/8"	6
M29404	Each	11/32"	.3438	3-7/16"	4-3/4"	6
M29405	Each	23/64"	.3594	3-1/2"	4-7/8"	6
M29406	Each	3/8"	.3750	3-5/8"	5"	6
M29407	Each	25/64"	.3906	3-3/4"	5-1/8"	6
M29408	Each	13/32"	.4062	3-7/8"	5-1/4"	6
M29409	Each	27/64"	.4219	3-15/16"	5-3/8"	6
M29410	Each	7/16"	.4375	4-1/16"	5-1/2"	6
M29411	Each	29/64"	.4531	4-3/16"	5-5/8"	6
M29412	Each	15/32"	.4688	4-5/16"	5-3/4"	6
M29413	Each	31/64"	.4844	4-3/8"	5-7/8"	6
M29414	Each	1/2"	.5000	4-1/2"	6"	6



MILL SUPPLY CO., INC.

Phone (410) 485-3343
Fax (410) 325-2240

Toll Free 1-800-817-8183

Tools

BORING TOOLS

Screw Machine Length Bits :

- 135 degree split point
- Made of high speed steel
- Sold by each
- Fractional size



Item #	U/M	Size	Decimal	Flute Length	Overall Length	Quantity Per Pack
M29643	Each	1/16"	.0625	5/8"	1-5/8"	12
M29644	Each	5/64"	.0781	11/16"	1-11/16"	12
M29645	Each	3/32"	.0938	3/4"	1-3/4"	12
M29646	Each	7/64"	.1094	13/16"	1-13/16"	12
M29647	Each	1/8"	.1250	7/8"	1-7/8"	12
M29648	Each	9/64"	.1406	15/16"	1-15/16"	12
M29649	Each	5/32"	.1562	1"	2-1/16"	12
M29650	Each	11/64"	.1719	1-1/16"	2-1/8"	12
M29651	Each	3/16"	.1875	1-1/8"	2-3/16"	12
M29652	Each	13/64"	.2031	1-3/16"	2-1/4"	12
M29653	Each	7/32"	.2188	1-1/4"	2-3/8"	12
M29654	Each	15/64"	.2344	1-5/16"	2-7/16"	12
M29655	Each	1/4"	.2500	1-3/8"	2-1/2"	12
M29656	Each	17/64"	.2656	1-7/16"	2-5/8"	12
M29657	Each	9/32"	.2812	1-1/2"	2-11/16"	12
M29658	Each	19/64"	.2969	1-9/16"	2-3/4"	6
M29659	Each	5/16"	.3125	1-5/8"	2-13/16"	6
M29660	Each	21/64"	.3281	1-11/16"	2-15/16"	6
M29661	Each	11/32"	.3438	1-11/16"	3"	6
M29662	Each	23/64"	.3594	1-3/4"	3-1/16"	6
M29663	Each	3/8"	.3750	1-13/16"	3-1/8"	6
M29664	Each	25/64"	.3906	1-7/8"	3-1/4"	6
M29665	Each	13/32"	.4062	1-15/16"	3-5/16"	6
M29666	Each	27/64"	.4219	2"	3-3/8"	6
M29667	Each	7/16"	.4375	2-1/16"	3-7/16"	6
M29668	Each	29/64"	.4531	2-1/8"	3-9/16"	6
M29669	Each	15/32"	.4688	2-1/8"	3-5/8"	6
M29670	Each	31/64"	.4844	2-3/16"	3-11/16"	6
M29671	Each	1/2"	.5000	2-1/4"	3-3/4"	6



MILL SUPPLY CO., INC.

Phone (410) 485-3343
Fax (410) 325-2240

Toll Free 1-800-817-8183

Tools

BORING TOOLS

Masonry Bits :

- Wide Spiral
- Carbide tipped for cement, block, brick, and mortar
- For 1/4" drills
- For use on brick, block, tile, stone, cement and mortar, marble and fiberglass
- Sold per each

* Many other drill bits are available that are not pictured in this catalog. (Contact your sales representative for more information).



Item #	U/M	Size	Length	Item #	U/M	Size	Length
M29701	Each	1/8"	3"	M29711	Each	1/4"	6"
M29702	Each	1/8"	6"	M29712	Each	5/16"	4"
M29703	Each	5/32"	3"	M29713	Each	5/16"	6"
M29704	Each	5/32"	6"	M29714	Each	3/8"	4"
M29705	Each	11/64"	3"	M29715	Each	3/8"	6"
M29706	Each	3/16"	4"	M29716	Each	7/16"	6"
M29707	Each	3/16"	6"	M29717	Each	1/2"	4"
M29709	Each	7/32"	4"	M29718	Each	1/2"	6"
M29710	Each	1/4"	4"				

Hammer Bits :

- Carbide tipped for cement, block, brick, and mortar
- Sold per each



Item #	U/M	Size	Drilling Depth	Item #	U/M	Size	Drilling Depth	Shank Dia.
M29498	Each	1/8" x 3"	1-1/2"	M29511	Each	5/16" x 4"	1-1/2"	9/32"
M29499	Each	1/8" x 6"	4-1/2"	M29512	Each	5/16" x 6"	4-1/2"	9/32"
M29500	Each	5/32" x 3"	1-1/2"	M29513	Each	3/8" x 4"	1-1/2"	11/32"
M29501	Each	5/32" x 6"	4-1/2"	M29514	Each	3/8" x 6"	4-1/2"	11/32"
M29502	Each	11/64" x 3"	1-1/2"	M29515	Each	7/16" x 6"	4-1/2"	3/8"
M29503	Each	3/16" x 4"	2-1/2"	M29516	Each	15/32" x 6"	4-1/2"	3/8"
M29504	Each	3/16" x 6"	4-1/2"	M29517	Each	1/2" x 6"	4-1/2"	3/8"
M29505	Each	7/32" x 3"	1-1/2"	M29518	Each	9/16" x 6"	4-1/2"	3/8"
M29506	Each	7/32" x 6"	4-1/2"	M29519	Each	5/8" x 6"	4-1/2"	1/2"
M29507	Each	1/4" x 4"	2-1/2"	M29520	Each	11/16" x 6"	4-1/2"	1/2"
M29508	Each	1/4" x 6"	4-1/2"	M29521	Each	3/4" x 6"	4-1/2"	1/2"
M29509	Each	9/32" x 4"	2-1/2"	M29522	Each	7/8" x 6"	4-1/2"	1/2"
M29510	Each	9/32" x 6"	4-1/2"	M29523	Each	1" x 6"	4-1/2"	1/2"



MILL SUPPLY CO., INC.

Phone (410) 485-3343
Fax (410) 325-2240

Toll Free 1-800-817-8183

Tools

BORING TOOLS

High Speed Steel Tap Sets :

- Includes Taper, Plug, and Bottoming
- Packed in 3pc set
- Reclosable plastic pouch
- Sold per set
- H3 thread limit

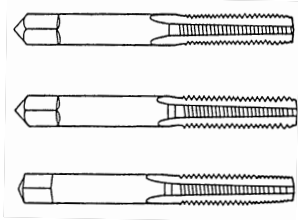

Item #	U/M	Size	Shank Dia.	# Flutes
M29768	Set	1/4"x20 NC	9/32"	4
M29769	Set	5/16"x18 NC	9/32"	4
M29771	Set	3/8"x16 NC	11/32"	4
M29772	Set	7/16"x14 NC	11/32"	4
M29773	Set	1/2"x13 NC	3/8"	4
M29761	Set	8x32 NC	3/8"	4
M29763	Set	10x24 NF	3/8"	4
M29765	Set	10x32 NF	3/8"	4

Lock Installation Kit :

- The 2 most popular diameters for lock installation allow accurate installation in wood or metal doors



Item # M28998
U/M - Each

1/4" Pilot Drill :

- Specifically designed for hole saws
- Flute is shorter than standard 1/4" drill bits
- Bit is notched to prevent "spin out"
- High speed steel



Item # M29001
U/M - Each

Arbor Extension :

- 12" shank for 7/16" arbors
- Sold per each
- Screw holds arbor securely in place

Item # M28996
U/M - Each



MILL SUPPLY CO., INC.

Phone (410) 485-3343
Fax (410) 325-2240

Toll Free 1-800-817-8183

Tools

BORING TOOLS

Hole Saws :

- Cuts holes in wood, plastic, or any machinable metal including: nail-embedded wood, plywood, pipe, stainless steel, etc.
- Attached arbor saves time
- Bi-metal construction ensures teeth stay sharp
- M3 cutting edge for higher wear resistance
- 4/6 variable pitch reduces vibration
- Positive rake for fast cutting
- 1-1/2" cutting depth for cutting through 2 x 4's
- Sold per each



Tools

Item #	U/M	Size (Dia)	Pipe Tap Size
M28890	Each	5/8"	
M28893	Each	11/16"	
M28896	Each	3/4"	
M28899	Each	7/8"	3/4"
M28902	Each	15/16"	
M28905	Each	1"	
M28908	Each	1-1/16"	
M28911	Each	1-1/8"	1"
M28914	Each	1-3/16"	
M28917	Each	1-1/4"	
M28920	Each	1-5/16"	
M28923	Each	1-3/8"	
M28926	Each	1-1/2"	
M28929	Each	1-5/8"	
M28932	Each	1-3/4"	1-1/2"
M28935	Each	1-7/8"	
M28938	Each	2"	
M28941	Each	2-1/16"	
M28944	Each	2-1/8"	
M28947	Each	2-1/4"	2"
M28950	Each	2-3/8"	
M28953	Each	2-1/2"	
M28956	Each	2-5/8"	2-1/2"
M28959	Each	2-3/4"	
M28962	Each	2-7/8"	
M28965	Each	3"	
M28968	Each	3-1/8"	
M28971	Each	3-1/4"	3"
M28974	Each	3-1/2"	
M28977	Each	4"	



MILL SUPPLY CO., INC.

Phone (410) 485-3343
Fax (410) 325-2240

Toll Free 1-800-817-8183

Tools

CUTTING TOOLS

Tool Box Saw :

STANLEY

- Compact design fits in any tool box
- Aggressive 3-sided tooth design cuts 50% faster than conventional handsaws
- Handle offers a square/mitre feature with 45 & 90 degree angles
- 9 points per inch
- 15" long blade



Item # M20185
U/M - Each

Crosscut Handsaw :

STANLEY

- Hardened, tempered polished steel blade for durability
- Hardwood handle for comfort and control
- Full length protective sleeve
- 8 points per inch
- 26" long blade



Item # M20176
U/M - Each

Drywall Saw :

STANLEY

- Heavy duty, specially designed rounded tooth and gully prevents clogging
- Teeth are sharpened and set
- 5-1/2 points per inch
- 15" blade length

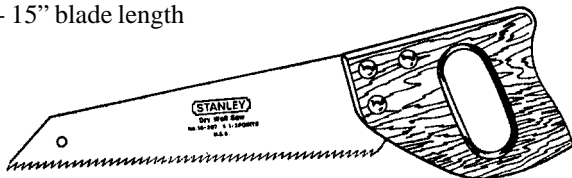

Item # M20131
U/M - Each

Wallboard Saw :

STANLEY

- For all gypsum wallboard, sheetrock and plastic materials
- Make cleanouts for electric outlets, etc
- Self-starting point sharpened for plunge cuts
- Blade is epoxy-bonded and ferruled to stained wood handle, which holds the blade up to three times longer than competitive blades, which are not epoxy bonded



Item # M20149
U/M - Each

Compass Saw :

STANLEY

- For cutting out curved shapes in wood, plasterboard or plywood
- High grade tempered steel blades
- Teeth are precision set and sharpened for fast and smooth cutting
- 8 points per inch
- 14" blade length

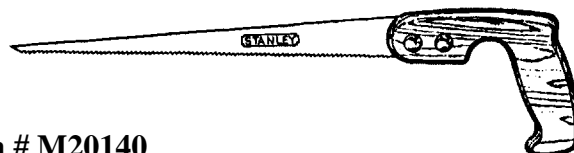

Item # M20140
U/M - Each



MILL SUPPLY CO., INC.

Phone (410) 485-3343
Fax (410) 325-2240

Toll Free 1-800-817-8183

Tools

CUTTING TOOLS

Coping Saw :

STANLEY

- Finest professional quality
- Rich, walnut stained hardwood handle
- Blade is highest grade high carbon steel-hardened and tempered to give clean, controllable cutting action

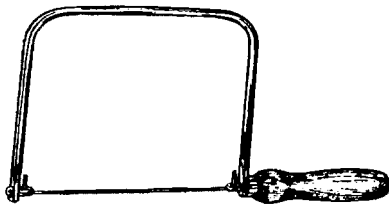

Item # M20122
U/M - Each

Pruning Saw :

UnionTools
Quality You Can Count On

- This saw has a narrow blade made of finely tempered steel with reverse teeth to permit sawing on the pull stroke
- Teeth are accurately sharpened and set
- Solid hardwood handle with lacquered finish for long life



Item # M20194
U/M - Each

Rubber Grip Hacksaw :

STANLEY

- Rigid steel frame with molded cushion grip
- D-shape guard protects hand and knuckles
- Adjustable frame



Item # M20158
U/M - Each

Mini Hacksaw :

Nicholson®

- Uses regular hacksaw blades
- For hard-to-get-at places and light-duty cutting
- Durable molded frame offers maximum hand comfort



Item # M20167
U/M - Each

12" Combination Bowsaw & Hacksaw :

Nicholson®

- Two saws in one! Comes with 2 blades: Hacksaw for metal and plastic, a bowsaw for wood and general yard work
- Built-in hand safety guard helps prevent injuries
- Hacksaw blade in high speed steel
- Bowsaw blade cuts in both directions
- Full 6" throat makes cutting plastic pipe easy

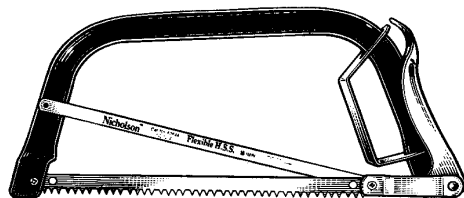

Item # M24216
U/M - Each

Replacement Bow Saw
Blade for Bowhack

Item # M24223
U/M - Each



MILL SUPPLY CO., INC.

Phone (410) 485-3343
Fax (410) 325-2240

Toll Free 1-800-817-8183

Tools

CUTTING TOOLS

Bi-Metal Hacksaw Blades :



- Superior flexibility
- Will not shatter
- Vacuum heat treated for long life and faster cutting
- Cuts wood, plastic or any machinable metal; including conduit, stainless steel tubing, structural materials, etc
- Sold per each

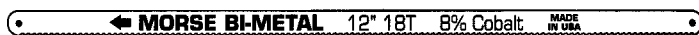

Item #	U/M	Size	TPI	Qty. per Box
M28807	Each	12"x1/2"x.025"	14	100
M28808	Each	12"x1/2"x.025"	18	100
M28809	Each	12"x1/2"x.025"	24	100
M28812	Each	12"x1/2"x.025"	32	100

High Speed Molybdenum Hacksaw Blades :



- Extra rigidity vs other HSS flexible blades
- Shatter resistant
- Good performance in low tension frames
- Cuts wood, plastic or any machinable metal; including conduit, stainless steel tubing, structural materials, etc
- Sold per each



Item #	U/M	Size	TPI	Qty. per Box
M28824	Each	10"x1/2"x.025"	24	100
M28827	Each	12"x1/2"x.025"	18	100
M28830	Each	12"x1/2"x.025"	24	100
M28833	Each	12"x1/2"x.025"	32	100

Economy Carbon Hacksaw Blades:



- Low cost alternative in general purpose applications
- Carbon steel blade
- Cuts wood, plastic and easy to machine metals such as conduit, aluminum, copper tubing, etc
- Sold per each



Item #	U/M	Size	TPI	Qty. per Box
M28815	Each	12"x1/2"x.025"	18	100
M28818	Each	12"x1/2"x.025"	24	100
M28821	Each	12"x1/2"x.025"	32	100



MILL SUPPLY CO., INC.

Phone (410) 485-3343
Fax (410) 325-2240

Toll Free 1-800-817-8183

Tools

CUTTING TOOLS

Fast Cut Circular Saw Blade :

- Fully hardened steel body prevents blade warping and binding
- Thicker body provides increased durability in heavy-duty applications
- Precision sharpened teeth for fast, smooth cuts and longer life
- Blade coating prevents rust and reduces friction
- 7-1/4" diameter, 20 Teeth
- Application; For fast rips, cross cuts, and miters in hardwoods, softwoods, plywood, and chip board. Ideal general purpose blade when speed of cut is of primary importance

Item # M24920
U/M - Each

Hollow Ground Planer Circular Saw Blade :

- Fully hardened steel body prevents blade warping and binding
- Thicker body provides increased durability in heavy-duty applications
- Precision sharpened teeth for fast, smooth cuts and longer life
- Blade coating prevents rust and reduces friction
- 7-1/4" diameter, 60 Teeth
- Application; For a chip-free sanded like finish in all solid woods and dimensional lumber

Item # M24929
U/M - Each

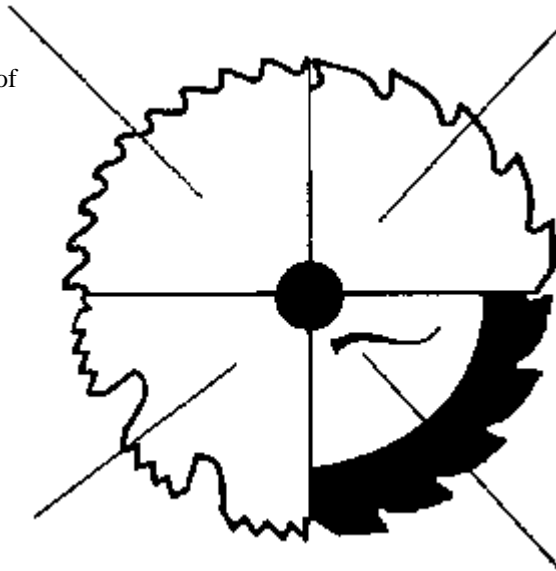
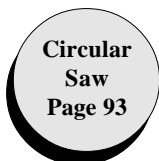

Combination Circular Saw Blade :

- Fully hardened steel body prevents blade warping and binding
- Thicker body provides increased durability in heavy-duty applications
- Precision sharpened teeth for fast, smooth cuts and longer life
- Blade coating prevents rust and reduces friction
- 7-1/4" diameter, 40 Teeth
- Application; For fast and smooth rips, cross cuts, and miters in hardwoods, softwoods, plywood, and chip board. Ideal all-purpose blade. Eliminates blade changing when working with different materials and applications

Item # M24925
U/M - Each

Carbide Tipped Combination Circular Saw Blade :

- 25 degree hook angle for faster, freer cutting
- Thin kerf design for fast and smooth cutting action
- Heat vents allow blade to run cooler, reducing blade flexing and binding
- Superior cutting speed, quality, and durability with carbide blades
- 7-1/4" diameter, 20 Teeth
- Application; For fast and smooth rips, cross cuts, and miters in hardwoods, softwoods, plywood, and chip board. Ideal all-purpose blade. Eliminates blade changing when working with different materials and applications

Item # M24933
U/M - Each

Economy Saw Blade :



- General purpose blade
- 7-1/4 x 24T
- Carbide Tipped



Item # M24919
U/M - Each



MILL SUPPLY CO., INC.

Tools

CUTTING TOOLS

10" Circular Saw Blade :

- Cuts like a blade, finishes like a sander and designed to optimize miter and table saw performance, providing the highest quality cuts to meet the needs of the most demanding craftsman
- Laser cut plate is precision balanced and tensioned for superior precision and accuracy
- Extra large, corrosion resistant C4 micrograin carbide stays sharper delivering the longest possible service life
- Precision tuned anti-vibration slots provide uncompromised surface finish
- Can be reground up to 20 times
- General purpose blade
- 10" diameter, 5/8" arbor, 60 Teeth

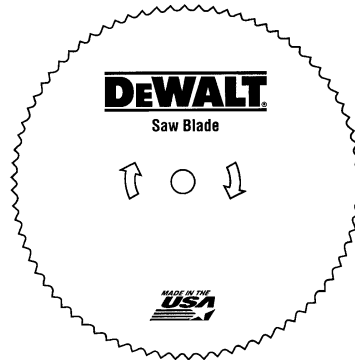

DEWALT

Item # M24940
U/M - Each

Power Hack Saw Blade :

- Bi-metal power blades, consisting of a high speed cutting edge welded to an alloy back, meets all plant safety requirements for long-lasting service under average shop cutting conditions
- To select the proper tooth spacing, three teeth minimum must be in contact with the work at all times

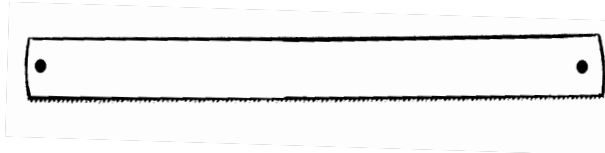

MORSE

Item #	U/M	Length	Width	Thickness	TPI
M28848	Each	18"	1-1/2"	.075"	6

Rod Saw Blade :

- Carbide grit rod saw blade
- Fits standard hack saw frames
- For difficult applications including glass, hardened steel, chains, bolts, hydraulic hose, stranded cable, etc.
- 12" length

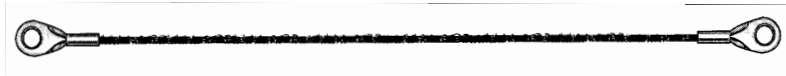

MORSE

Item # M28836
U/M - Each



MILL SUPPLY CO., INC.

Phone (410) 485-3343
Fax (410) 325-2240

Toll Free 1-800-817-8183

Tools

MORSE
Reciprocating Saw Blades

CUTTING TOOLS

Wood Saw Blade :

- Bi-metal 1/2" shank
- Long life, fast cutting
- 6 teeth per inch
- 9"x3/4"x.050"
- General rough-in, all woods, nail embedded wood
- Sold per each



Item # M28878
U/M - Each

Wood Saw Blade :

- Bi-metal 1/2" shank
- Long life, fast cutting
- 6 teeth per inch
- 6"x7/16"x.050"
- General rough-in scroll cuts, all woods, nail embedded wood
- Sold per each

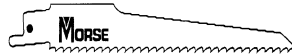

Item # M28875
U/M - Each

Wood & Metal Saw Blade :

- Bi-metal 1/2" shank
- Long life, fast cutting
- 10/14 teeth per inch
- 4"x3/4"x.035
- Heavy gauge metal, rubber & fiber, nail embedded wood
- Sold per each

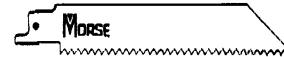

Item # M28854
U/M - Each

Wood & Metal Saw Blade :

- Bi-metal 1/2" shank
- Long life, fast cutting
- 10 teeth per inch
- 6"x3/4"x.035
- Wood, nail embedded wood, compositions, plastic, cast aluminum and non-ferrous metals.
- Sold per each



Item # M28862
U/M - Each

Heavy Gauge Metal Saw Blade :

- Bi-metal 1/2" shank
- Long life, fast cutting
- 14 teeth per inch
- Heavy gauge metals 1/8" thick and above. Barstock and angles.
- Sold per each



Item #	U/M	Size
M28857	Each	4"x3/4"x.035"
M28863	Each	6"x3/4"x.035"
M28879	Each	12"x3/4"x.035"

Metal Saw Blade :

- Bi-metal 1/2" shank
- Long life, fast cutting
- 18 teeth per inch
- Heavy gauge metals of 18 gauge to 1/8" thick conduit, pipe, channels, and tubing.
- Sold per each

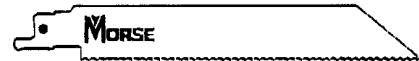

Item #	U/M	Size
M28860	Each	4"x3/4"x.035"
M28869	Each	6"x3/4"x.035"

Metal Saw Blade :

- Bi-metal 1/2" shank
- Long life, fast cutting
- 24 teeth per inch
- Metal cutting 18 gauge and under. Trim and tubing. Galvanized pipe under 18 gauge.
- 6"x3/4"x.035"
- Sold per each

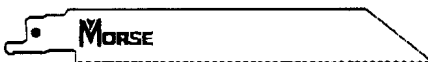

Item # M28872
U/M - Each

5pc Saw Blade Set :

- Bi-metal 1/2" shank
- Long life, fast cutting
- 1/ea M28857, M28860, M28863, M28869, M28875.
- Reusable plastic sleeve
- Sold per pack



Item # M28881
U/M - Pack

Wood Saw Blade :

- Carbon Steel 1/2" shank
- Economical alternative to Bi-metal blades
- Fast cutting, long life
- 6 teeth per inch
- 12"x3/4"x.050"
- General rough-in, all woods
- Sold per each



Item # M28884
U/M - Each



MILL SUPPLY CO., INC.

Phone (410) 485-3343
Fax (410) 325-2240

Toll Free 1-800-817-8183

Tools

Tools

CUTTING TOOLS

5pc Jig Saw Blade Set :

- Bi-metal 1/2" shank
- Long life, fast cutting
- 1/ea 4"x6T for wood, fiberboard, asbestos
- 1/ea 4"x10T for wood, plywood, hard-board
- 1/ea 4"x14T for non-ferrous metals, fiberglass, hard rubber, nail-embedded wood
- 1/ea 3"x18T for metal 18 gauge or less
- 1/ea 3"x24T for metal & non-ferrous metal up to 1/8" thick
- Sold per pack

Item # M28887
U/M - Pack

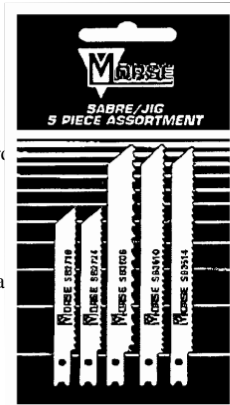

5pc Jig/Sabre Saw Blade Set:

- 1/4" Universal shank
- Contains 1/ea: High speed steel 4x5/8x8T for plastic, hardwood, wood with nails, and non-ferrous metal.
- 1/ea carbon 4x5/16x6T for softwood, hardwood, plywood, chipboard, plastics up to 2" thick
- 1/ea carbon 4x5/16x10T for softwood, hardwood, plywood, chipboard, plastics up to 2" thick
- 1/ea carbon 4x5/16x10T reverse tooth, non-splitting cuts of laminates and chipboard
- 1/ea carbon 4x1/4x10/24T scroll for curve cutting, chipboard, and plastic up to 1" thick
- Sold per pack only

Item # M29006
U/M - Pack

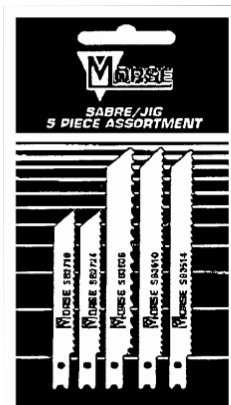

Coping Saw Blades :

- High-carbon steel
- Heat treated and tempered for strength
- For medium turns in wood 1/8" to 1-1/2" thick
- 15 TPI
- Made in U.S.A.
- Sold in pack of 4 blades

Item # M20113
U/M - Pack

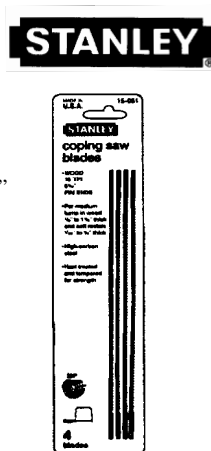

Utility Knife Blades :

- Fits all standard utility knives
- Made in U.S.A.
- Sold 5 blades per pack

Item # M21520
U/M - Pack

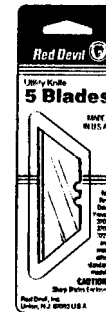

Utility Knife Blade Dispenser Unit :

- 100 Heavy Duty Blades
- Ultra high impact plastic case
- Unit can be fastened to wall with nails or screws for easy access.

Item # M29011
U/M - Pack

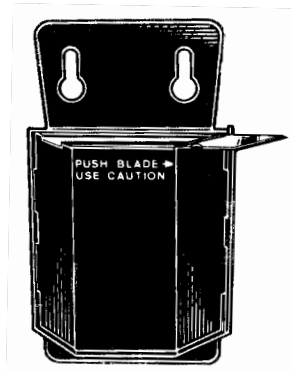

Single Edge Razor Blades :

- 100 Industrial blades
- Surgical carbon steel
- Individually shelled
- Fits all standard razor blade tools
- Made in U.S.A.

Item # M29013
U/M - Box



MILL SUPPLY CO., INC.

Phone (410) 485-3343
Fax (410) 325-2240

Toll Free 1-800-817-8183

Tools

CUTTING TOOLS

Heavy Duty Utility Knife Blades :

- Fits all standard utility knives
- Made of tough carbon-steel
- Made in U.S.A.
- Sold 5 blades per pack

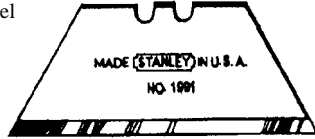

Item # M20095
U/M - Pack



Hook Knife Blades :

- Fits all standard utility knives
- Both ends of blade are razor sharp to cut full thickness in one stroke.
- Cuts linoleum, roofing material, cartons, etc. without damage.
- Made in U.S.A.
- Sold 5 blades per pack

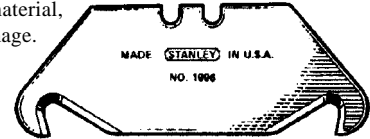

Item # M20104
U/M - Pack



Heavy Duty Carpet Knife Blades :

- Individually shelled
- 100 Industrial blades
- Fits all standard carpet knives
- Made in U.S.A.

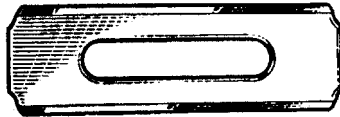

Item # M20086
U/M - Box



Heavy Duty Breakaway Blade Safety Dispenser:

- Safely stores used blades
- 10 carbon steel blades
- Fits all standard break-away knives
- Easy to discard

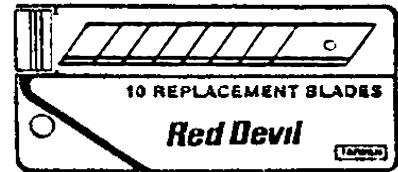

Item # M21136
U/M - Pack



Utility Knife :

- Contains 5 blades
- Blade adjusts securely in 3 cutting positions
- For crisp cuts and scores on all types of surfaces
- Made in U.S.A.



Item # M29012
U/M - Each

Quick Change Utility Knife :

- Contains 3 heavy duty blades
- Changes blades quickly without a screwdriver
- Swing out blade storage magazine
- String cutting feature
- Made in U.S.A.

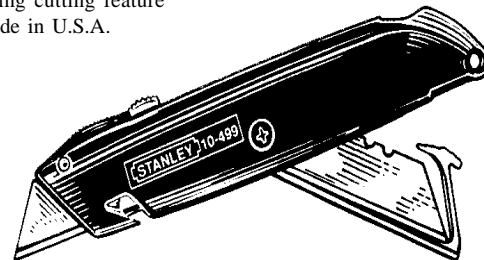

Item # M20068
U/M - Each



MILL SUPPLY CO., INC.

Phone (410) 485-3343
Fax (410) 325-2240

Toll Free 1-800-817-8183

Tools

CUTTING TOOLS

Carpet Knife :

- Retractable blade for controlling depth of blade
- Three knife blades in handle
- Angled handle design provides easy access to hard-to-reach places

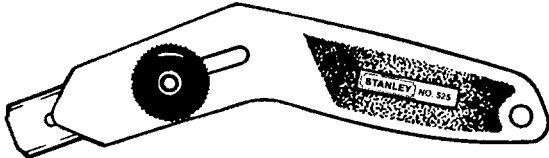

Item # M20077
U/M - Each

Replacement Blades for Carpet Knife
Item # M20086 U/M - Box

18MM Heavy Duty Automatic Razor Knife :



- Breakaway blade locks itself into position
- 10 blades, 80 cutting edges
- Stainless steel track

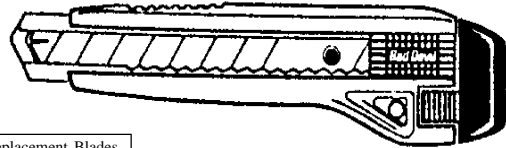

Item # M21124
U/M - Each

Replacement Blades for Carpet Knife
Item # M21136 U/M - Pack

Box Cutter :

- Use to cut, score, trim
- Retractable blade



Item # M21120
U/M - Each

Replacement Blade for Box Cutter
Item # M29013 U/M - Box

Hacking Knife :



- For general purpose cutting
- Rugged 1-1/4" wide blade
- Triple riveted construction
- 4-1/2" / 114mm blade



Item # M21116
U/M - Each

Heavy Duty Mill Knife :



- For heavy duty cutting
- Hardwood handle
- 14 gauge
- 4"x1-1/4" blade



Item # M21188
U/M - Each

Square Point Knife :



- For general purpose cutting
- Hardwood handle
- Nickel plated ferrule
- 16 gauge
- 6"x1" blade



Item # M21176
U/M - Each



MILL SUPPLY CO., INC.

Phone (410) 485-3343
Fax (410) 325-2240

Toll Free 1-800-817-8183

Tools

CUTTING TOOLS

Industrial Sharp Point Knife :

- For general purpose cutting
- Smooth hardwood handle provides a comfortable grip
- Nickel plated ferreule



Item # M21160
U/M - Each

2-1/2" All Purpose Flooring Knife :

- Extra sharp, heavy duty, two-sided blade for removing / scoring carpeting, linoleum, vinyl, drywall, roofing, insulation



Item # M21108
U/M - Each

Glass Cutter :

- Industrial quality
- Use for straight cutting on standard glass



Item # M21408
U/M - Each

Plexiglass Cutting Tool :

- Use to scribe and break acrylic plastic sheets
- Super-sharp steel blade



Item # M21416
U/M - Each

Ceramic Tile Nipper :

- Super-tough carbide cutting edges for precision work and long life
- Shapes and contours tiles up to 5/8" thick

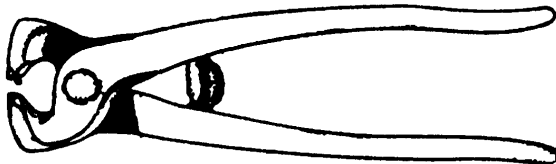

Item # M21448
U/M - Each

Ceramic Tile Cutter :

- Carbide wheel for extra long life
- Upper jaw has breakaway bar

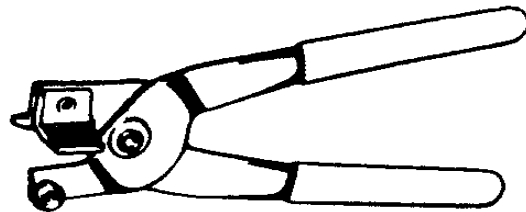

Item # M21456
U/M - Each

Ceramic
Tile
Page 164



MILL SUPPLY CO., INC.

Phone (410) 485-3343
Fax (410) 325-2240

Toll Free 1-800-817-8183

Tools

CUTTING TOOLS

"Kut-All" Tile Cutter :

- Makes square cuts on 12"x12" vinyl composition tile and for cutting cove base
- Strong aluminum base has a calibrated rear ledge for fast measurements of cuts
- Hardened steel blades are easily replaced when dull
- Not for solid vinyl tile
- Cutter weighs only 6-1/4 lbs

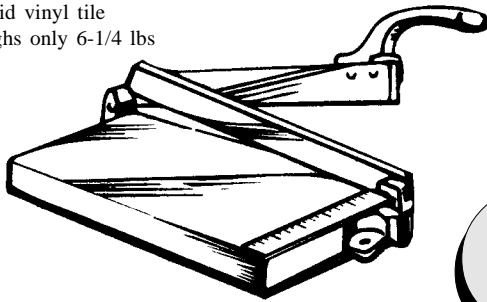

Item # M43377
U/M - Each

Superior Tile Cutter :

- Made from sturdy cast aluminum alloy and steel for heavy duty lengthy service
- Scores and breaks tile and trim pieces without moving the material
- Spring tension to provide automatic adjustment to the breaker for straight cuts every time
- Cuts tile up to 6" straight and 4-1/2" diagonally

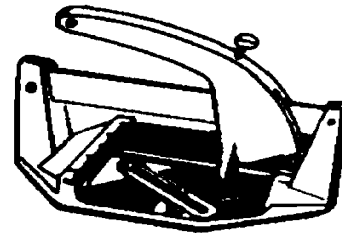

Item # M43379
U/M - Each

Ceramic
Tile
Page 164

Slamscrapper Impact Tool :

- Removes carpeting, linoleum, ceramic tile, mastics, roof shingles, ice, roots, etc
- Unique sliding "hammer action" generates super power (150 lbs. PSI)
- Blade is 3" x 6"



Item # M21431
U/M - Each

Replacement Blade
For Impact Tool

Item # M21432
U/M - Each

Diagonal Cutting Pliers :

- Designed for general wire cutting, flush cutting, or in confined spaces
- Standard jaw
- Blade length 13/16" for 6"
- Blade length 1" for 7"
- Round joint design
- Made of drop forged alloy steel and individually tested for strength and cutting ability
- Polished head
- Non-slip cushion handle grips



Item #	U/M	Size
M24633	Each	6"
M24634	Each	7"



MILL SUPPLY CO., INC.

Phone (410) 485-3343
Fax (410) 325-2240

Toll Free 1-800-817-8183

Tools

CUTTING TOOLS

Long Nose Side Cutting Pliers :

Crescent®

- Designed for reaching confined areas
- Long chain nose with fine serrated jaws to make wire loops and bends
- Electronically induction hardened and hardened side cutting edges
- Made of forged alloy tool steel and tested for strength and cutting
- Polished head
- Non-slip cushion handle

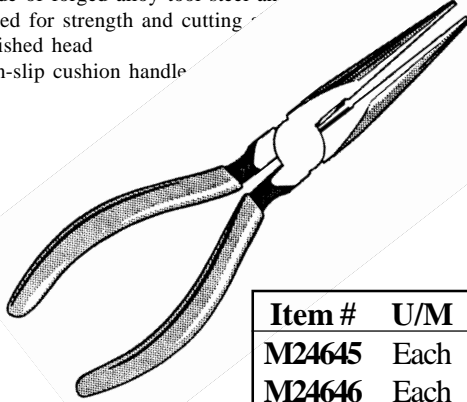

Item #	U/M	Size
M24645	Each	6-5/8"
M24646	Each	7-1/2"

Side Cutting Linemans Pliers :

Crescent®

- Streamlined head design allows easy sliding in and out of belt loops
- Cutting edges cut clean and remain sharp
- Made of forged alloy steel
- 7-1/4" are round nosed
- Non-slip cushion handle grips

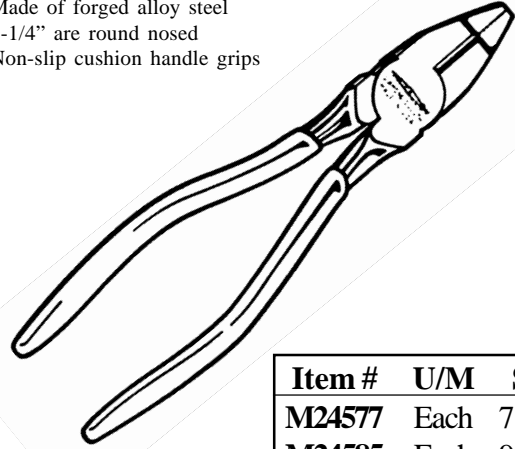

Item #	U/M	Size
M24577	Each	7-1/4"
M24585	Each	9-1/4"

Wire Cutter / Crimper :

Crescent®

- 5 in 1 scissor action tool - wire cutter, wire stripper, bolt cutter, plier and crimper
- Pliers nose permits wire pulling and looping
- Cleanly snips and cuts 20 - 10 gauge wire
- Cuts bolts through No. 10, leaving perfect lead thread
- Crimps insulated and non-insulated solderless terminals
- Lifetime pivot bearing
- Cushion handle grips



Item # M24456
U/M - Each

Multimaster Snips :

Wiss®

- Combines the long cut of tinner's snips with the strength of compound action
- Compound action multiplies the force of the hand by five times
- Great for making long, fast cuts in several types of material including: paper, plastic, sheet metal, aluminum, vinyl siding, screening, and much more
- Cuts up to 20 gauge steel
- Features non-slip, serrated jaws and textured grips

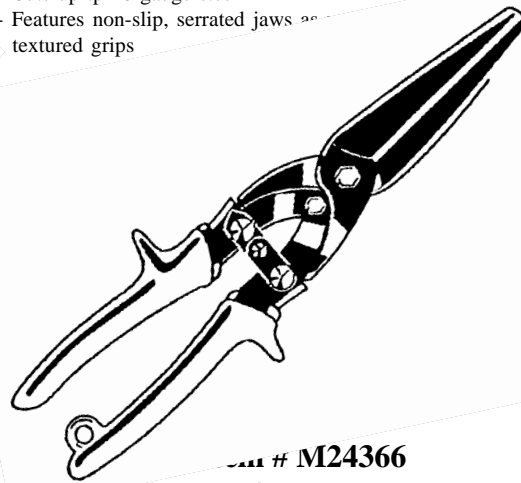

Item # M24366
U/M - Each



MILL SUPPLY CO., INC.

Phone (410) 485-3343
Fax (410) 325-2240

Toll Free 1-800-817-8183

Tools

CUTTING TOOLS

Multimaster Compound Action Snips :

Wiss®

- Non-slip serrated jaws are made extra tough, wear-resistant molybdenum steel to provide extra service demanded by the compound lever action
- Withstands severe strain of cutting heavy stock and tight curves
- Handles are formed of high strength steel
- Color coated

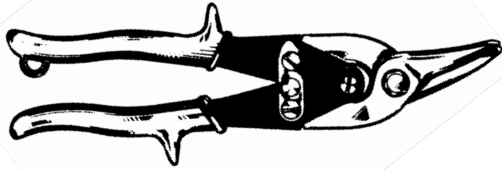

Item #	U/M	Handle	Cuts
M24348	Each	Red	↙↘
M24354	Each	Green	↖↗

Multimaster Compound Action Snips :

Wiss®

- Non-slip serrated jaws are made extra tough, wear-resistant molybdenum steel to provide extra service demanded by the compound lever action
- Withstands severe strain of cutting heavy stock and tight curves
- Handles are formed of high strength steel
- Yellow coated handles for easy identification
- Cuts straight, left or right

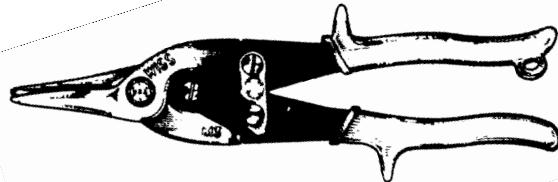

Item # M24360
U/M - Each

Multimaster Offset Snips :

Wiss®

- Offset blades keep hands clear of metal
- Non-slip serrated jaw of tough molybdenum steel allows for compound lever action
- Withstands strain of cutting heavy stock and tight curves
- Spring-action for fast, effortless feed
- Non-slip, textured grips and safety latch for superior control

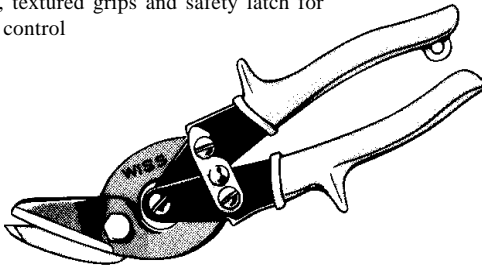

Item #	U/M	Handle	Cuts
M24372	Each	Red	↙↘
M24378	Each	Green	↖↗

Heavy Duty Industrial Shears :

Wiss®

- Finest quality cutlery steel
- Black handle
- Hot drop-forged polished blades
- 10-1/4" long
- Blade length 4-3/4"

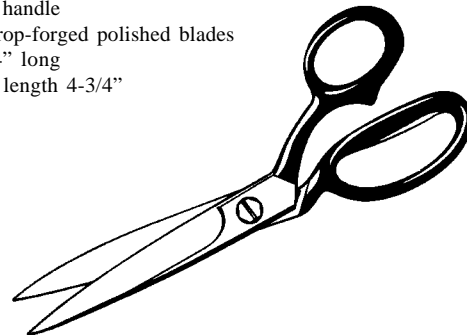

Item # M24126
U/M - Each



MILL SUPPLY CO., INC.

Phone (410) 485-3343
Fax (410) 325-2240

Toll Free 1-800-817-8183

Tools

CUTTING TOOLS

Bolt Cutters :

- Designed for greater mechanical advantage, these cutters give quick, easy cuts of rod, reinforcing rod, wire mesh, cable, steel strap and bolts
- All parts are heat treated for maximum strength and wear resistance
- Rolling cam gives greater efficiency
- Jaws are hardened alloy steel and slim head permits cutting close to surface
- Cam/Bolt and Gear Mesh assure quick easy adjustment and synchronized jaw action
- Center cut

RIDGID

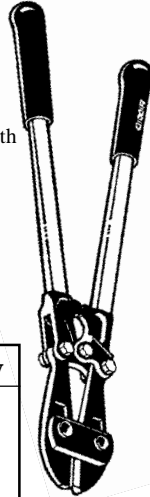

Item #	U/M	Length	Capacity
M22088	Each	14"	1/4"
M22092	Each	18"	5/16"
M22104	Each	24"	3/8"
M22110	Each	30"	7/16"
M22112	Each	36"	1/2"
M22119	Each	42"	9/16"

Plastic Pipe and Tube Cutter :

RIDGID

- Designed for quick, clean cuts through 2-3/8" O.D.
- Features a compound leverage ratchet mechanism and a hardened steel blade
- Simple operation provides quick cuts with ease
- The housing is made of lightweight aluminum for long trouble-free service

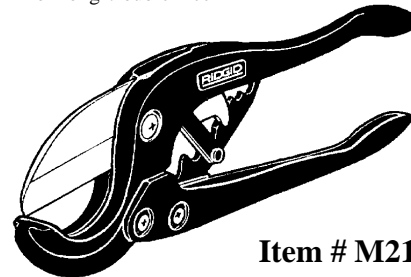

Item # M21808
U/M - Each

Midget Tubing Cutter :

- This tubing cutter is specifically designed for use in extra close quarters on small size hard and soft copper, aluminum, brass and plastic tubing
- Two rollers opposite cutter wheel permit easier rotation and faster cutting
- Slide and wheel housing are strong and light weight
- Large, knurled feed screw knob gives easy control of cutting pressure for cleanouts
- Capacity 1/8"-15/16" O.D.
- Turning radius 1-11/16" max

RIDGID

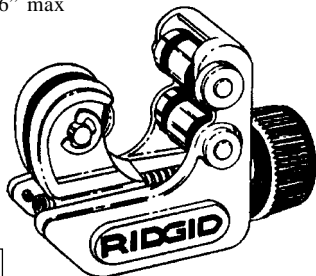

Replacement Wheel
For # M21916 Cutter

Item # M21948
U/M - Each

Item # M21916
U/M - Each

Enclosed Feed Screw Tubing Cutter :

RIDGID

- Enclosed feed screw to eliminate clogging and jamming
- Grooved rolls for close-to-flare cuts
- Fold-away reamer
- Spare cutter wheel in the handle
- Cuts copper, brass, aluminum tubing and thin-wall conduit
- Cuts 1/8"-1-1/8" O.D.

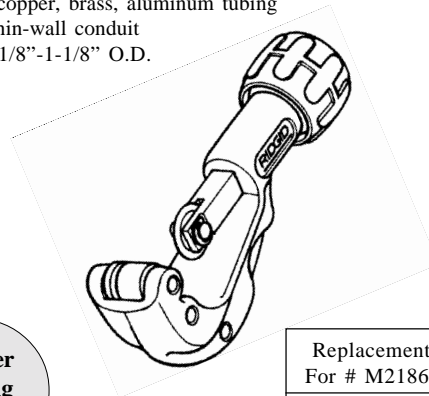

Replacement Wheel
For # M21869 Cutter

Item # M21948
U/M - Each

Item # M21869
U/M - Each

Copper
Tubing
Page 305



MILL SUPPLY CO., INC.

Phone (410) 485-3343
Fax (410) 325-2240

Toll Free 1-800-817-8183

Tools

FINISHING TOOLS

Putty Knife :

- Professional quality
- Black polypropylene solvent-resistant handle is designed for maximum safety and dependability.
- High-carbon, precision-ground steel blade is laquered to prevent rust and extends through the handle.



Item #	U/M	Width	Type	Qty. per Box
M21016	Each	1-1/4"	Stiff	12/ea
M21012	Each	1-1/4"	Flexible	12/ea
M21018	Each	1-1/2"	Stiff	12/ea
M21020	Each	1-1/2"	Flexible	12/ea
M21032	Each	2"	Stiff	12/ea
M21031	Each	2"	Flexible	12/ea

6 & 1 Tool :

- Scraper, gouger, putty remover, roller cleaner, spreader and nail setting head
- Professional quality
- Black polypropylene solvent-resistant handle is designed for maximum safety and dependability.
- High-carbon, precision-ground steel blade is laquered to prevent rust and extends through the handle.



Item # M21544
U/M - Each

Mud Pan :

- Durable plastic tray with built-in steel blade edges for wiping excess from taping knife

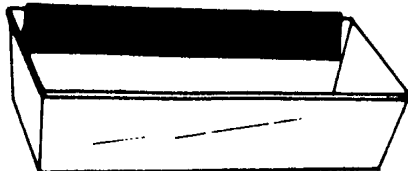

Item # M21068
U/M - Each

Taping Knives :

- Professional quality
- Black polypropylene solvent-resistant handle is designed for maximum safety and dependability.
- High-carbon, precision-ground steel blade is laquered to prevent rust and extends through the handle.
- The brass plated head can be used for setting drywall nails and other hammering jobs.
- Flexible blade

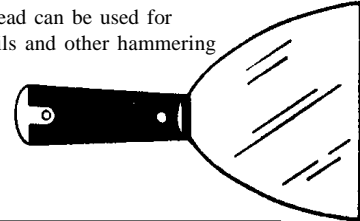

Item #	U/M	Width
M21050	Each	4"
M21004	Each	5"
M21052	Each	6"

Inside Corner Taping Knife :

- For inside corner taping and joint compound.
- Stainless steel blade set at 103 degrees flexes to 90 degrees to handle inside corners tightly.
- Solid wood handle

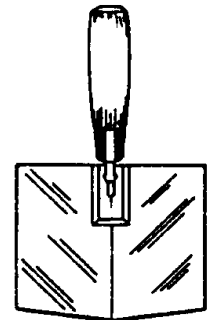

Item # M21099
U/M - Each

Drywall Taping Knife :

- Flexible blue steel blade
- Tape and patch professionally
- Tempered for maximum strength, laquered to prevent rusting
- Long comfortable wood handle

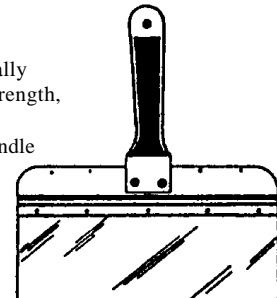

Item #	U/M	Width
M21091	Each	8"
M21092	Each	10"

Joint Tape
Page 19

Joint Compound
Page 154



MILL SUPPLY CO., INC.

Phone (410) 485-3343
Fax (410) 325-2240

Toll Free 1-800-817-8183

Tools

FINISHING TOOLS

Heavy Duty Scraper :

- Removes paint and stickers from glass, mirrors or windshields
- Metal construction opens like a pocket knife
- Push button release
- Locks in three scraping positions
- 5 blades included

Replacement Blades For Scraper
Item # M29013 U/M - Box

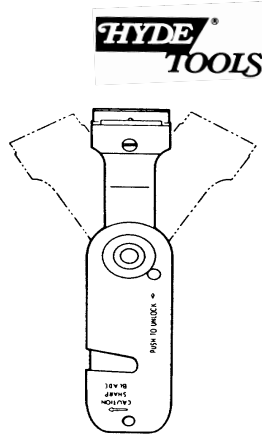

Item # M21100
U/M - Each

Ergonomic Scraper :

- The bio-engineered shape fits the fist for better grip and precise control.
- Large ribbed control button for safer operation.
- Extra firm blade clamp holds blade strong pressure.
- 5 blades included

Replacement Blades For Scraper
Item # M29013 U/M - Box

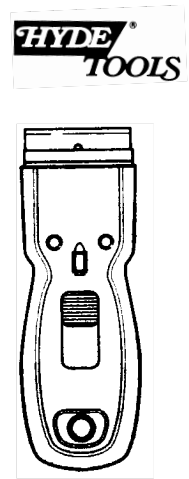

Item # M21096
U/M - Each

3" Wallpaper Stripper :

- Removes wallpaper and wall fabric quickly and easily
- Scrapes paint and stickers from glass
- Non-slip handle



Replacement Blade For Scraper - 2/pk
Item # M21528 U/M - Pack

Item # M21512
U/M - Each

2-1/2" Heavy Duty Wood Scraper :

- Easy grip knob
- 4 edge steel blade
- Designed for two-handed power
- Contour handle

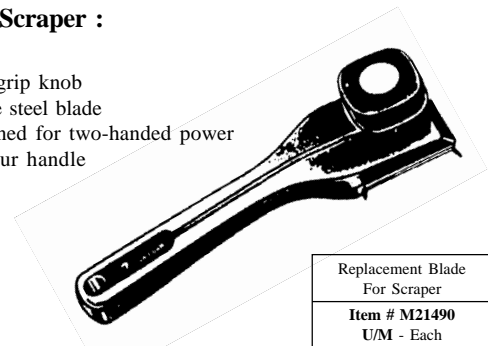

Replacement Blade For Scraper
Item # M21490 U/M - Each

Item # M21488
U/M - Each

Professional Aluminum Pole Sander Head :

- 9-3/8" x 3-1/4"
- Special threaded adapter
- Die-cast aluminum head
- Makes sanding ceilings and walls from floor easy and safe
- **Pole not included**

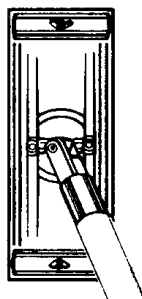

Item # M21064
U/M - Each

48" Wood Pole :

- For use with pole sander
- Threaded end
- 1-5/8" diameter
- Can also be used with roller frames

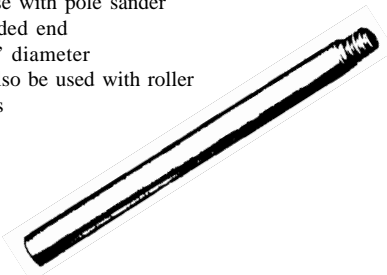

Item # M21065
U/M - Each

Drywall Sandpaper
Page 20



MILL SUPPLY CO., INC.

Phone (410) 485-3343
Fax (410) 325-2240

Toll Free 1-800-817-8183

Tools

Tools

FINISHING TOOLS

Scrape & Pry Bar :

- Hardened tempered steel
- For pulling nails, scraping paint, and opening boxes
- Chisel edge on both ends
- 1-3/4" x 9-5/8"

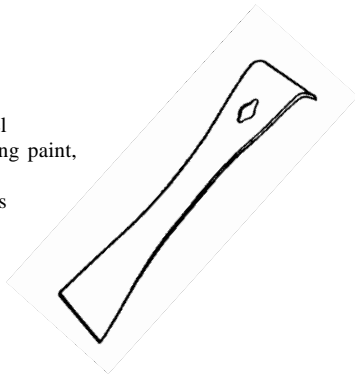

Item # M21536
U/M - Each

Push / Pull Window Scraper :

- Perfect for scraping window/glass and stickers, as well as many home/workplace scraping jobs
- Push/pull action locks blade in place for use, retracts for safe storage
- One blade included

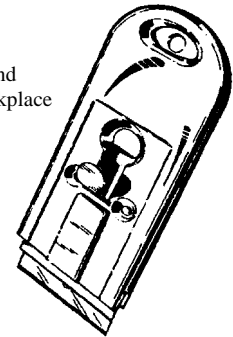

Replacement Blades For Scraper
Item # M29013 U/M - Box

Item # M21504
U/M - Each

Ratchet Type Caulk Gun :

- For medium and light consistency caulk, sealants and adhesives
- Steel construction ensures long lasting use
- 1/10 gallon - 11 oz tubes

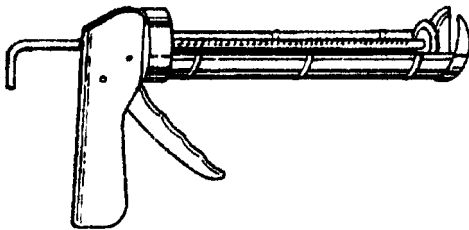

Item # M42519
U/M - Each

Deluxe Ratchet Type Caulk Gun :

- For all grades of caulk, sealants and adhesives
- Built in spout cutter
- Built in seal puncture tool
- Professional quality
- 1/10 gallon - 11 oz tubes

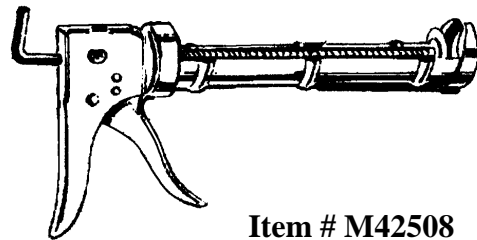

Item # M42508
U/M - Each



Super Ratchet Type Caulk Gun :

- For all grades of caulk, sealants and adhesives
- Super thrust makes extrusion of stiff caulks and sealants easy
- Built in spout cutter
- Built in puncture tool and ladder hook
- 1/4 gallon - 29 oz tubes

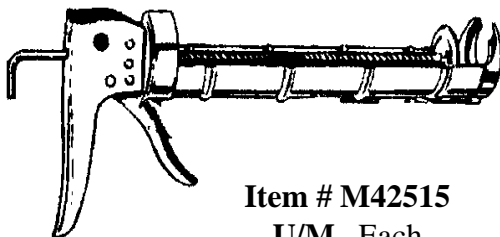

Item # M42515
U/M - Each

Push Points :

- Push easily into place with putty knife
- Zinc coated
- Aprox. 60 points per pack



Item # M21424
U/M - Pack



MILL SUPPLY CO., INC.

Phone (410) 485-3343
Fax (410) 325-2240

Toll Free 1-800-817-8183

Tools

FINISHING TOOLS

Surform Flat File :



- More comfortable and versatile to use than a traditional file
- Manufactured with a metallic grey, die-cast alloy body
- Handle made of tough polypropylene
- Fitted with a replaceable 10" standard cut blade
- 17-3/8" overall length
- 1-5/8" wide

Replacement Blade For File
Item # M20295 U/M - Each



Item # M20283
U/M - Each

Surform Round File :



- Especially useful for enlarging holes and smoothing curved surfaces
- Ideal for pipe fittings in MDF or chipboard
- Manufactured with a tough polypropylene handle and thumb support
- Fitted with a replaceable 10" round blade
- 15-3/4" overall length

Replacement Blade For File
Item # M20280 U/M - Each



Item # M20292
U/M - Each

Rub Brick :



- Contoured handle minimizes fatigue
- Fastest cutting medium for dressing down all kinds of concrete
- 6" x 3" x 1" thick

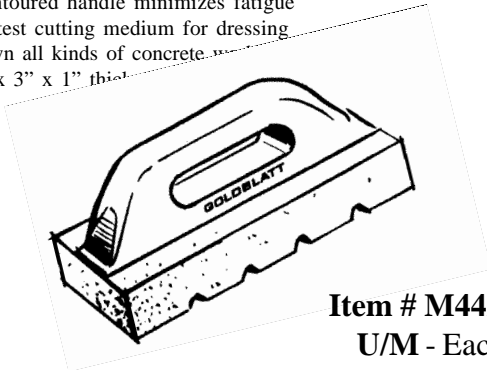

Item # M44266
U/M - Each

Masonry / Grout Float :



- For concrete surfacing
- 1/2" thick, fine texture sponge rubber pad
- Aluminum
- Polypropylene
- 4" x 9"

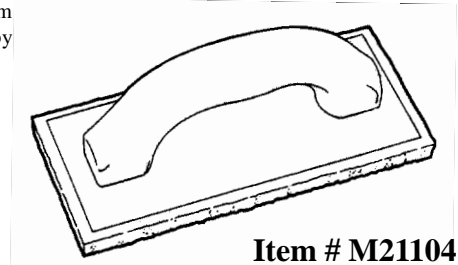

Item # M21104
U/M - Each

Magnesium Masonry Float :



- Magnesium blades have a very fine, hard and dense grain structure
- Broken-in face, for immediate use
- Durable magnesium will not warp, lasts longer and is easy to clean
- 20" x 3-1/2"

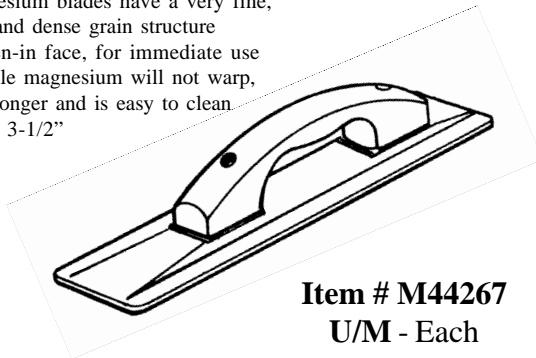

Item # M44267
U/M - Each

Knee Pads :



- Rubber construction/heavy-duty for long life and comfort
- Adjustable web straps

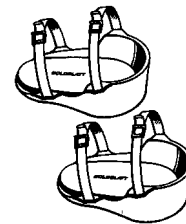

Item # M44303
U/M - Pair

Masonry
Brush
Page 193



MILL SUPPLY CO., INC.

Phone (410) 485-3343
Fax (410) 325-2240

Toll Free 1-800-817-8183

Tools

Tools

FINISHING TOOLS

Pointing Trowel :

GOLDBLATT

- Precision forged from high quality carbon steel
- Wood handle
- Flexible and eas
- 5-1/2" long blad

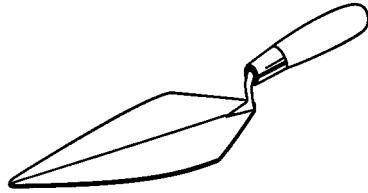

Item # M44286
U/M - Each

Margin Trowel :

GOLDBLATT

- Precision forged from high quality carbon steel
- Steel ferruled maple handle will not move
- Durable, yet easy to use
- 5" x 2" blade

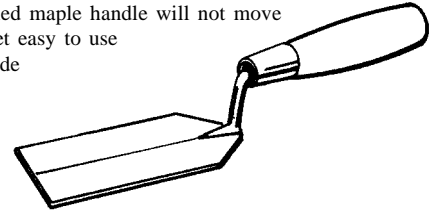

Item # M44261
U/M - Each

Brick Trowel :

GOLDBLATT

- Precision forged from high quality carbon steel
- Taper-ground for perfect balance and shape
- Sturdy, lightweight and easy to use
- Philadelphia style
- Wood handle
- 11" x 5-1/2" blade

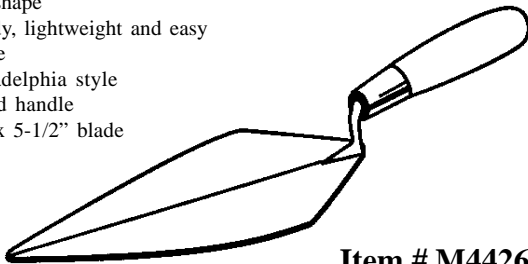

Item # M44260
U/M - Each

Aluminum Lute Rake :

UnionTools
Quality You Can Count On

- Designed for spreading concrete and asphalt rapidly
- 28 teeth
- 36" x 4" he
- One edge s
- Bolted bra
- 82" alumi

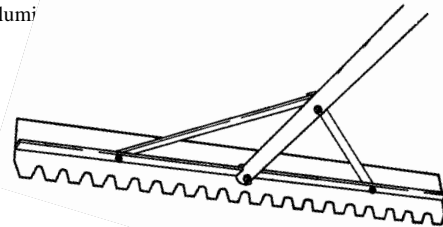

Item # M55731
U/M - Each

Concrete Mix
Page 156

Finishing Trowel :

GOLDBLATT

- Carbon steel for concrete finishing
- Factory sanded surface for a comfortable easy to use tool
- Ultra-smooth wood handle
- Strong, lightweight rustproof aluminum mountings
- Mounting "locked" to blade with elec fused rustproof studs

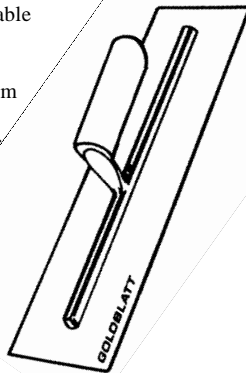

Item #	U/M	Size
M44298	Each	14" x 4"
M44300	Each	16" x 4"

aided Line :

- Numerous uses
- #18
- 250' spools
- Available in 3 colors



Item #	U/M	Width
M14676	Roll	White
M14670	Roll	Yellow
M14673	Roll	Pink

Line Level
Page 80



MILL SUPPLY CO., INC.

Phone (410) 485-3343
Fax (410) 325-2240

Toll Free 1-800-817-8183

Tools

Tools

FINISHING TOOLS

Notched Trowel :

- Sturdy, die cast, all aluminum frame with hardwood handle
- Steel is of the highest quality-tempered, ground, and polished for maximum durability
- Mounted with brass rivets
- Used for applying all types of adhesives
- 4-1/2" x 11"
- U-Notched 3/32" x 1/8"

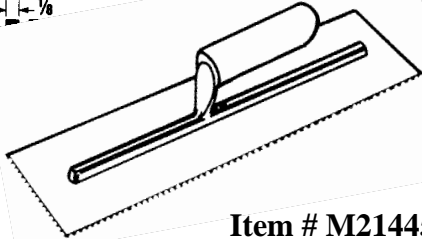
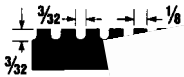

Item # M21445
U/M - Each

Adhesive Spreader :

- Plastic Handle
- Used for applying linoleum and asphalt adh
- 3" wide
- Square-Notched 3/32" x 1/8"

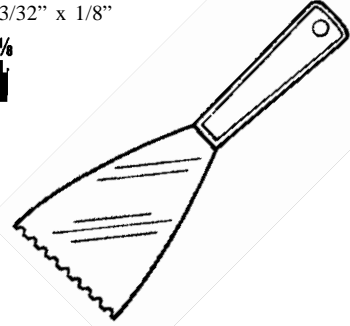
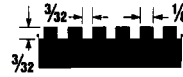

Item # M21440
U/M - Each

Adhesive
Page 153 & 154
Floor Tile
Page 166

Grout Rake :

- Professional style with offset handle to protect knuckles
- Cleans and removes old grout from between tiles
- Comes with two blades: 1 carbide tipped and 1 saw toothed for fast debris removal

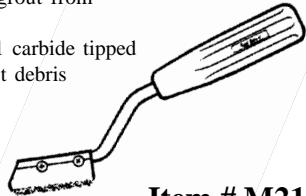

Item # M21471
U/M - Each

Grout Rake Blades:

- Fits our grout rake # M21471
- Comes with two blades:
1 carbide tipped and 1 saw toothed for fast debris removal

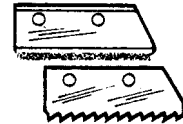

Item # M21472
U/M - Pack

4-Way Rasp :

- For use on woods and plastics
- Four different cutting surfaces
- One side offers a flat rasp and a double cut file
- The other side offers a half round rasp and a double cut file
- Blades are manufactured from high carbon file steel
- Comes with molded handle

STANLEY

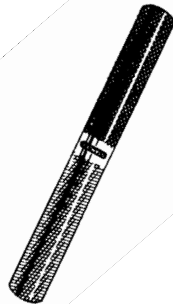

Item # M20301
U/M - Each

Combination Chisel-Wood Rasp :

Nicholson®

- Three tools in one: a wood chisel, a round rasp and flat rasp
- Steel strike plate on handle-resists "mushrooming" and breakage
- Polished and ground blade-extremely sharp cuts
- Includes: 1 each 1/2", 3/4" and 1" tool

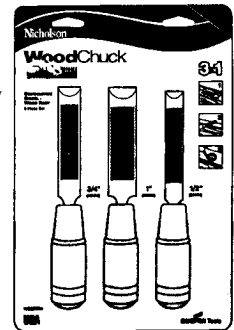

Item # M24748
U/M - Each



MILL SUPPLY CO., INC.

Phone (410) 485-3343
Fax (410) 325-2240

Toll Free 1-800-817-8183

Tools

FINISHING TOOLS

* Many other files are available that are not pictured in this catalog. (Contact your sales representative for more information).

Flat File :

- Used by machinists, machinery builders, ship and engine builders, repairman and others who require rapid removal of material
- Rectangular in cross section with bevel slightly towards point
- Double-cut on one side



Item #	U/M	Length	Pattern
M23720	Each	8"	Bastard
M23721	Each	8"	2nd Cut
M23722	Each	8"	Smooth
M23729	Each	10"	Bastard
M23730	Each	10"	2nd Cut
M23731	Each	10"	Smooth
M23738	Each	12"	Bastard
M23739	Each	12"	2nd Cut
M23740	Each	12"	Smooth

Half Round File :

- Used on concave, convex and flat surfaces
- Rounded on one side, flat on opposite
- Backs of bastard and second cut files are double cut
- Backs of smooth files are single cut
- Flat sides of all are double cut



Item #	U/M	Length	Pattern
M23723	Each	8"	Bastard
M23724	Each	8"	2nd Cut
M23725	Each	8"	Smooth
M23732	Each	10"	Bastard
M23733	Each	10"	2nd Cut
M23734	Each	10"	Smooth
M23741	Each	12"	Bastard
M23742	Each	12"	2nd Cut
M23743	Each	12"	Smooth

Full Round File :

- Primarily used to file circular or concave surfaces
- Round in shape
- Single cut
- Tapered slightly



Item #	U/M	Length	Pattern
M23726	Each	8"	Bastard
M23727	Each	8"	2nd Cut
M23728	Each	8"	Smooth
M23735	Each	10"	Bastard
M23736	Each	10"	2nd Cut
M23737	Each	10"	Smooth
M23744	Each	12"	Bastard
M23745	Each	12"	2nd Cut
M23746	Each	12"	Smooth

File Information

Pattern :

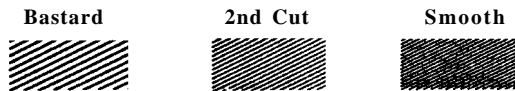

Cut :

Single Cut

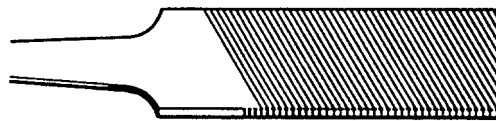

Double Cut

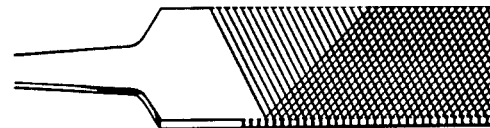

MILL SUPPLY CO., INC.

Phone (410) 485-3343
Fax (410) 325-2240

Toll Free 1-800-817-8183

Tools

Tools

MEASURING TOOLS

1/2" Wide Tape Rule :



- Mylar * coated blade for added durability
- Heat treated spring for longer life
- Positive blade lock will not creep while taking measurements
- Graduated in 16ths of an inch
- Belt clip is fastened on the back of case
- **10' length**

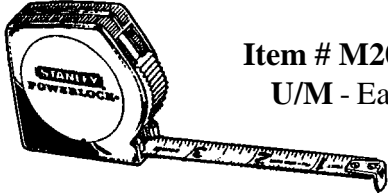

Item # M20337
U/M - Each

3/4" Wide Tape Rule :



- Mylar * coated blade for added durability
- Heat treated spring for longer life
- Positive blade lock will not creep while taking measurements
- Graduated in 16ths of an inch
- Belt clip is fastened on the back of case

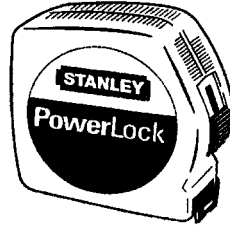

Item #	U/M	Length
M20346	Each	12'
M20328	Each	16'

1" Wide Tape Rule :



- Mylar * coated blade for added durability
- Heat treated spring for longer life
- Positive blade lock will not creep while taking measurements
- 16" and 19.2" stud center markings on blade for framing purposes
- Belt clip is fastened on the back of case
- **25' length**

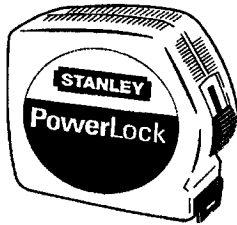

Item # M20355
U/M - Each

Lightweight Long Tape :



- Highly visable yellow case
- Yellow clad blade .005"/0.13mm thick
- Easy to wind drum
- Easy to read black and red markings
- Removable belt clip
- 3/8" thick blade

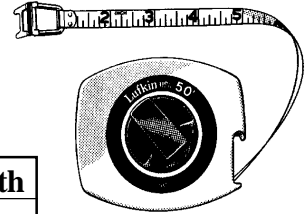

Item #	U/M	Length
M24031	Each	50'
M24033	Each	100'

1" Wide Power Tape Rule :



- 3" base for inside measurements
- Shock absorber protects end hook on return
- Case designed to fit your hand
- Non-glare ultra matte blade finish
- Four rivets in blade for added strength
- Toggle lock is positioned for convenient operation and holds the blade secure in any position
- **33' length**

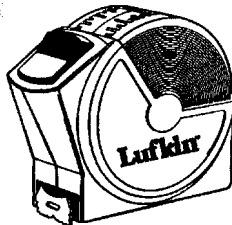

Item # M24028
U/M - Each

1" Vertical Read Tape Rule :



- Easy to read **vertical** numbering
- Four rivets in blade for added strength
- Durable, high impact case
- Case designed to fit your hand
- 3" base for inside markings
- Non-glare matte black finish



Item # M24041
U/M - Each



MILL SUPPLY CO., INC.

Phone (410) 485-3343
Fax (410) 325-2240

Toll Free 1-800-817-8183

Tools

MEASURING TOOLS

50' Self Winding Belt Tape Rule :

Lufkin®

- Unique blade graphics simplify layout work
- 1" wide steel blade, unique among tape measures
- Rigid 1" blade allows user to push blade for one man use
- 7-1/2" stand out, just like a power tape
- Durable ABS case in highly visible color is easy to find on job site
- Removable belt clip

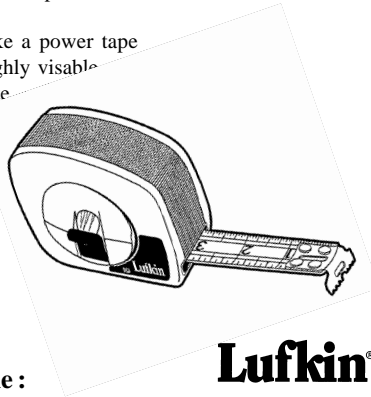

Item # M24029
U/M - Each

Ultrasonic Measuring Device :

Lufkin®

- Measures indoors from 2' -50'
- 2 position pivoting head
- LED display
- Push button operation
- 99% accurate
- Lithium battery
- Measures in feet or meters

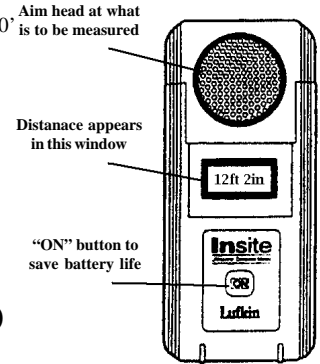

Item # M24060
U/M - Each

100' Linear Tape Rule :

Lufkin®

- Black and red markings-one side only
- Graduated feet and inches to 1/8ths; numbered with feet and instantaneous foot markings in red and inches in black
- 1/2" blade width
- Yellow clad blade
- Case made of high-impact polymer

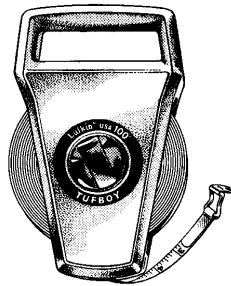

Item # M24017
U/M - Each

100' Linear Tape Replacement Blade :

Lufkin®

- Black and red markings-one side only
- Graduated feet and inches to 1/8ths; numbered with feet and instantaneous foot markings in red and inches in black
- 1/2" blade width
- Yellow clad blade
- Sold in rolls

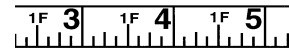

Item # M24018
U/M - Roll

Mill Supply Private Label Tape Measures

Mill Supply Tape Rule :

- Classic "Mill Supply" logo on side of tape
- 3 rivets in tip for added strength
- Stainless steel plate
- Blade stands to 7'3"
- Lifetime Warranty
- 16" stud and 19.2" truss marks
- Non-reflective blade
- Available in 3 highly visible colors
- Tape is 1" x 25' long

Use our
logo or yours

Private Label 1" Tape Rule :

- Same specifications as "Mill Supply" tape
- You must purchase at least 24 tape measures to qualify
- You must supply your artwork to us (No set-up costs to you)
- Please contact you sales representative for more information regarding this program

Item #	U/M	Color
M20802	Each	Chrome
M20804	Each	Red
M20805	Each	Black

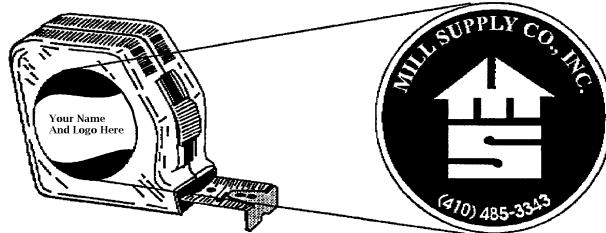

MILL SUPPLY CO., INC.

Phone (410) 485-3343
Fax (410) 325-2240

Toll Free 1-800-817-8183

Tools

MEASURING TOOLS

Folding Wood Rule :

Lufkin®

- Marked on both sides, both edges, 6' length
- Graduated to 1/16ths both edges;
- 16" stud centers marked in red
- Regular outside markings
- # M24054 (pictured) has inside markings; numbering begins on inside of rule; measurement lies close to the work
- # M24042 (not pictured) has outside markings; numbering begins on outside of rule

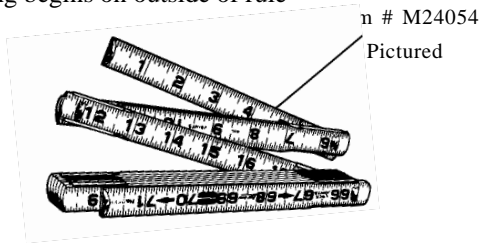

Item # M24042
U/M - Each

Item # M24054
U/M - Each

Folding Wood Rule w/Extension:

Lufkin®

- 6' length
- Graduated slide rule extends up to 6"
- Slide rule runs under friction in T-slot and stops at each end to prevent slide from falling out
- Marked on both sides and both edges
- Graduated to 1/16ths on both edges and 16" stud centers in red, regular markings on other edge

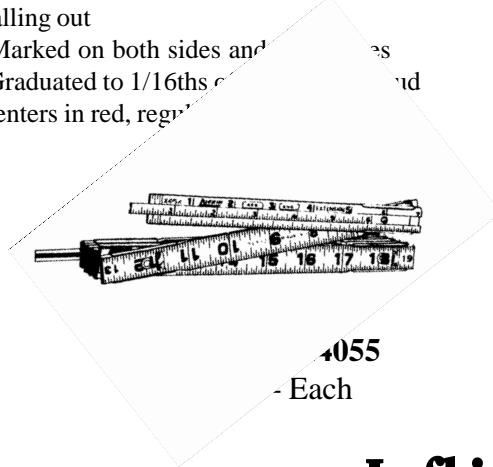

Item # M24055
- Each

Engineer's Folding Wood Rule :

Lufkin®

- 6' length
- Graduated in feet, 1/10ths and 1/100ths of feet
- Red foot figures
- Regular outside markings in feet, inches and 1/16ths
- Decimal point on engineer's scale prevents reading errors

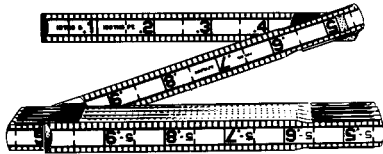

Item # M24048
U/M - Each

Modular Spacing Folding Wood Rule :

Lufkin®

- All sections have square ends
- Every joint opens on even number
- Inside marked with 6 scales in a 16" module
- The scales are as follows: 2 courses in 16" space (for concrete and glass blocks); 3 courses in 16" space (for facing tile); 4 courses in 16" space (for small facing tile and economy brick); 5 courses in 16" space (for engineered brick); 6 courses in 16" space (for roman brick)
- Scales include mortar space and spacing for 6" and 12" blocks
- Outside is graduated on both edges to 1/16ths
- The first end section is a short section which permits butting rule on the first 16" module

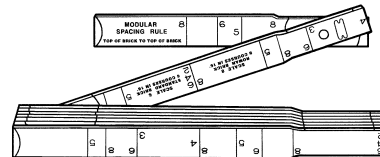

Item # M24192
U/M - Each



MILL SUPPLY CO., INC.

Phone (410) 485-3343
Fax (410) 325-2240

Toll Free 1-800-817-8183

Tools

LAYOUT TOOLS

Brass Bound Mason's Level :



- Large, tinted, break-resistant acrylic bent vials are field replaceable, east to read, extremely accurate (.001 per inch)
- Rubber gaskets allow for easy, no caulk vial replacement
- Individual laser engraved serial numbers for traceability
- Solid brass edges are pre-coated to prevent tarnish
- Hard rubber end caps are screwed into place
- Hollow grind process results in more accurate readings, and allows for wood dimensional changes
- 48" length

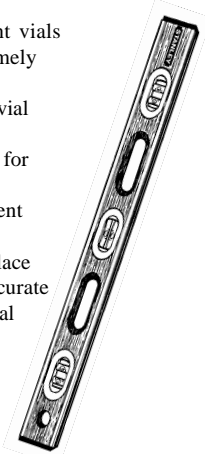

Item # M20391
U/M - Each

9" Torpedo Level :



- Top reading
- Made of tough, shock resistant ABS plastic material
- Three 360 degree vials, plumb, top read level, and 45 degree are replaceable on the job
- Strong magnetic strip on base that holds to iron and steel surfaces - allows for hands-free operation

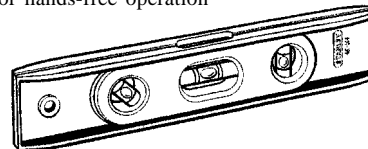

Item # M20382
U/M - Each

Line Level :



- Locks on cord easily, removes just as easily
- Flat base for surface leveling
- Accurate pretested vial
- Made from high strength aluminum

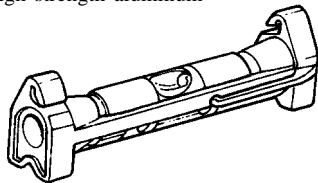

Item # M21964
U/M - Each

Braided Line
Page 74

Steel Carpenter's Square :



- Tempered steel designed for durability
- Deep graduations in 1/8" increments for easy reading on face and back
- Surface protected with a clear finish that resists rust
- Reverse reading scale
- Buffed finish
- Length 24"x2" x 16"x1-1/2"



Item # M20400
U/M - Each

Combination Square :



- Die cast metal handle has built in accuracy and durability
- Coated blade resists rust
- Scriber conveniently stores in handle
- Level vial increases versatility
- English read



Item # M20418
U/M - Each

Combination Square :



- Durable plastic handle for long life
- Coated blade resists rust
- Deep debossed graduations are more accurate and longer lasting
- Level vial increases versatility
- English read
- Plastic handle

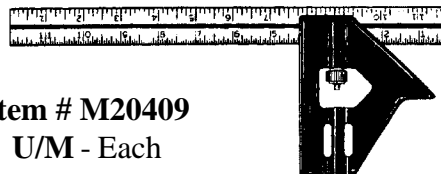

Item # M20409
U/M - Each



MILL SUPPLY CO., INC.

Phone (410) 485-3343
Fax (410) 325-2240

Toll Free 1-800-817-8183

Tools

Tools

LAYOUT TOOLS

T-Bevel :

- Tough plastic handle with handy grip
- Steel blade and blade locking device
- 8" blade
- 5-1/2" handle

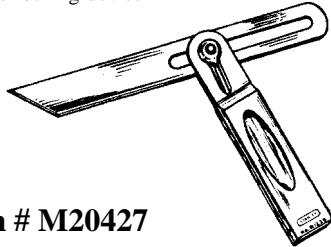

Item # M20427
U/M - Each



Gear Drive Chalk Line Reel :

- Super fast 4:1 rewind ratio saves time
- Tough ABS safety yellow case
- Universal hook designed to take on-the-job punishment
- Sliding door to fill chalk reel easily
- 100' length

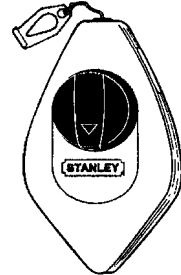

Item # M20463
U/M - Each



Chalk Line Reel :

- Durable, heavy-duty die cast body for extra long life
- Long wearing felt gasket hugs line and distributes uniform chalk coating
- Universal hook has been designed to endure the rigors of everyday use
- Can be used as a plumb bob

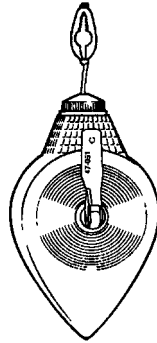

Item #	U/M	Length
M20445	Each	100'

Replacement Chalk Line :

- High quality replacement line
- 100' on reel

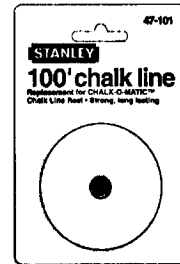

Item # M20454
U/M - Each



5 LB. Chalk :

- High grade chalk in vivid red color
- Packed in plastic canister with easy pouring spout
- 5 lb. container

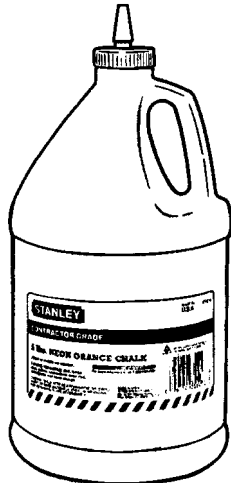

Item # M20490
U/M - Each



8 OZ. Chalk :

- High grade chalk in two vivid colors
- Packed in plastic bottle with twist-to-open cap
- 8 oz. bottle



Item #	U/M	Color
M20472	Each	Blue
M20481	Each	Red



MILL SUPPLY CO., INC.

Phone (410) 485-3343
Fax (410) 325-2240

Toll Free 1-800-817-8183

Tools

Tools

STRIKING TOOLS

Jacketed Graphite Nail Hammer :



- Extruded for maximum bend strength
- Solid graphite core extends to nib of handle
- Molded jacket for complete overstrike protection, maximum shock and vibration absorption
- Chemically resistant
- Curve claw, 13-1/4" length, 20oz.

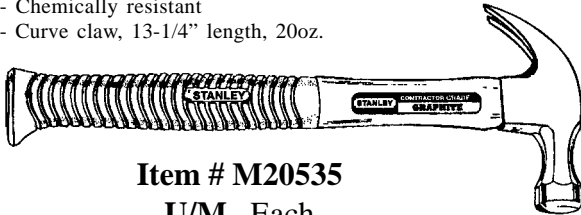

Item # M20535
U/M - Each

Wood Handle Nail Hammer :



- Select straight grain, hickory handle
- Triple wedge head-to-handle assembly prevents any loosening
- Octagon contour handle for a controlled swing
- High carbon, high polish steel head
- Available in rip (pictured) and curve claw

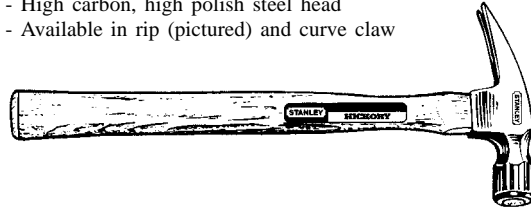

Ball Pein Hammer :



- High-carbon, steel forged head, hardened and tempered
- Rim tempered face minimizes chipping, assures greater safety
- Select clear lacquered hickory handle



Item #	U/M	Claw	Weight	Length
M20499	Each	Curved	16oz.	13-1/4"
M20508	Each	Rip	16oz.	13-1/4"

Item #	U/M	Size	Weight	Length
M20544	Each	3/0	8oz.	12-1/4"
M20553	Each	0	16oz.	14"

Blacksmith Hammer :



- New England pattern head
- Head forged from high quality, hardened and tempered steel
- Faces are ground and polished
- Selected clear lacquered hickory handle
- 2.5lb. weight, 5" head length

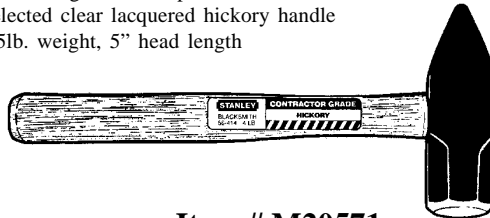

Item # M20571
U/M - Each

Engineer's Hammer :



- Professional quality
- Chamfered face
- 16"

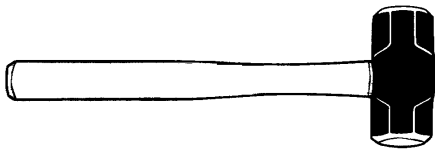

Item #	U/M	Weight	Stock Length
M55673	Each	3lb.	4-1/4"
M55674	Each	4lb.	4-3/4"

Cross Peen Hammer :



- Professional quality
- Chamfered face
- 16" hickory handle
- 4lb. weight, 5-3/4" stock length

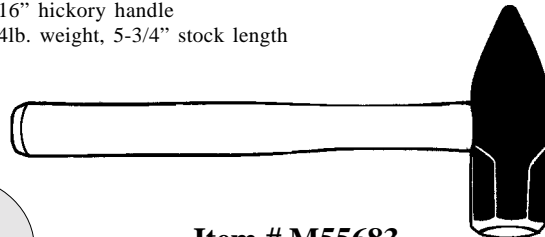

Item # M55683
U/M - Each



MILL SUPPLY CO., INC.

Phone (410) 485-3343
Fax (410) 325-2240

Toll Free 1-800-817-8183

Tools

STRIKING TOOLS

Drilling Hammer :



- Professional quality
- Chamfered face
- 10-1/2" hickory handle
- 4" stock length
- 2lb. head weight

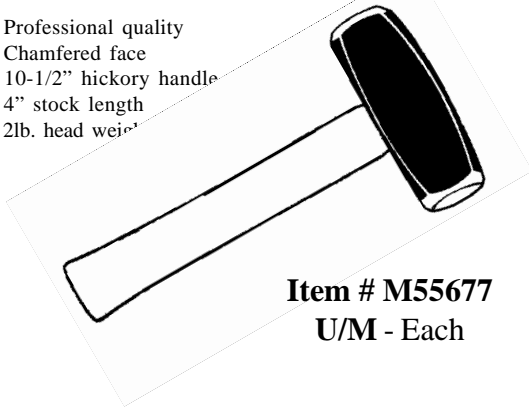

Item # M55677
U/M - Each

Sledge Hammer :



- Professional quality
- Chamfered face
- 36" hickory handle



Item #	U/M	Weight	Stock Length
M55662	Each	6lb.	6"
M55664	Each	8lb.	6-1/2"
M55666	Each	10lb.	6-3/4"
M55668	Each	12lb.	7"
M55670	Each	16lb.	8"

Soft Face Hammer :



- Replaceable tips are made of tough plastic that won't mar finely finished surfaces
- Handle is made of hickory and is securely locked in oval eye body
- Lacquered handle
- 16oz. head, 13-1/2" handle length

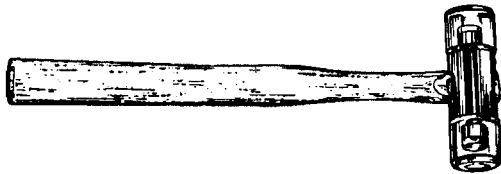

Item # M20589
U/M - Each

Rubber Mallet :



- Tough rubber head molded to a lacquered handle
- 13-3/4" length

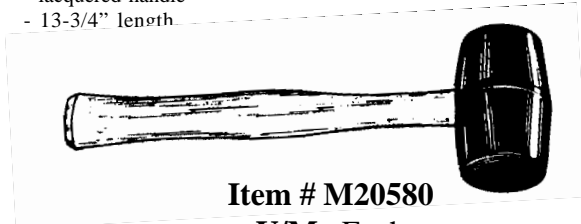

Item # M20580
U/M - Each

Wood Chisel :



- Durable precision-ground cutting edge
- Blade is heat treated, beveled and polished
- Width identification on handle for quick selection
- Blade is forged from high-quality, cutlery grade steel
- Extra-long, shatter-resistant handle provides better control and comfort during use
- Heavy-duty strike caps are crowned for centering blows and durability

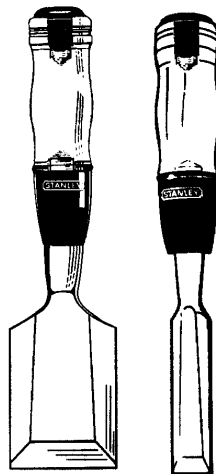

Item #	U/M	Size
M20203	Each	1/4"
M20204	Each	3/8"
M20205	Each	1/2"
M20206	Each	5/8"
M20207	Each	3/4"
M20208	Each	1"
M20209	Each	1-1/4"
M20210	Each	1-1/2"
M20211	Each	2"



MILL SUPPLY CO., INC.

Phone (410) 485-3343
Fax (410) 325-2240

Toll Free 1-800-817-8183

Tools

Tools

Tools

STRIKING TOOLS

Cold Chisel Set :

- Used for cutting metal that is softer than chisel's cutting edge
- Forged from alloy steel, one-piece construction
- Hardened and tempered for long life
- Blasted finish with rust preventative
- Set includes;
 - 1/ea 5-1/2" x 5/16", cutting edge is 3/8"
 - 1/ea 6" x 7/16", cutting edge is 1/2"
 - 1/ea 7" x 5/8", cutting edge is 3/4"
- Reuseable plastic pouch included

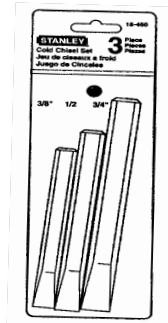

Item # M20256
U/M - Pack

Nail Set Pack :

- Square head, round knurled body
- Alloy steel hardened and tempered
- Tips are cupped and chamfered
- Square head prevents rolling
- Square stock size 5/16"
- Set includes;
 - 1/ea 4" x 1/32"
 - 1/ea 4" x 2/32"
 - 1/ea 4" x 3/32"



Item # M20598
U/M - Pack

Center Punch :

- Used for marking metal or making indentations for starting drill holes
- Forged from alloy steel, one-piece construction
- Hardened and tempered for long life
- Blasted finish with rust preventative
- 4-1/4" length, 5/16" size with a 5/32" point size

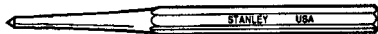

Item # M20274
U/M - Each

Wrecking Bar :

- Professional quality
- Goose neck pattern
- Slotted claw and chisel end

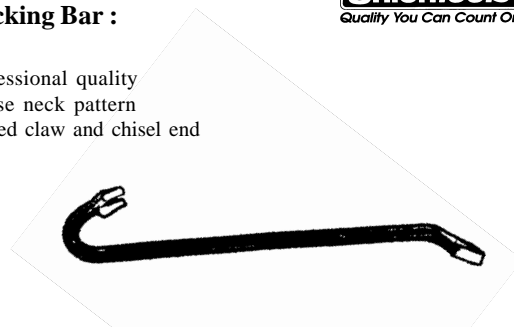

Item #	U/M	Length	Weight	Hex Size
M55710	Each	12"	1-1/4lb.	1/2"
M55711	Each	18"	2-1/4lb.	5/8"
M55712	Each	24"	3-1/4lb.	3/4"
M55713	Each	30"	4-1/4lb.	3/4"
M55714	Each	36"	5-1/4lb.	3/4"

Electrician's Flooring Chisel :

- Thin cutting blade for rough cuts
- Forged from chrome vanadium steel
- Full shank heat treatment
- 10-1/2" length
- 5/8" chisel, 2-1/2" cutting head



Item # M20265
U/M - Each

Pry Bar :

- Forged high carbon steel
- Heat treated for extra toughness
- Polished and beveled cutting edges
- Contoured bar is ideal for pulling nails, prying, lifting and separating
- Beveled nail

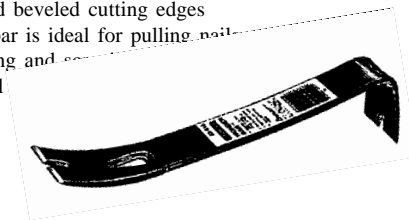

Item # M20562
U/M - Each



MILL SUPPLY CO., INC.

Phone (410) 485-3343
Fax (410) 325-2240

Toll Free 1-800-817-8183

Tools

FASTENING TOOLS

100 Plus Screwdrivers :



- Full size handles
- Alloy steel blade
- Precision-ground tip
- Chrome plated for corrosion resistance

Screws
Page 168,
169 & 170

Standard Blade / Standard Tip Screwdriver :

- Slotted tip
- Bolster blade for maximum strength

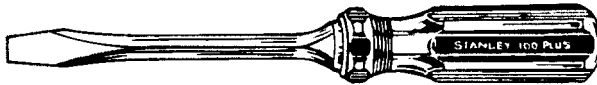

Item #	UM	O/A Length	Blade Len.	Blade Dia.	Tip Width
M20668	Each	6-3/4"	3"	7/32"	7/32"
M20697	Each	8-1/4"	4"	1/4"	1/4"
M20679	Each	13-1/4"	8"	3/8"	3/8"

Stubby Screwdriver :

- Slotted tip

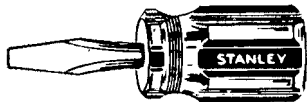

Item #	UM	O/A Length	Blade Len.	Blade Dia.	Tip Width
M20670	Each	1-1/2"	4"	1/4"	1/4"

Phillips Tip Stubby Screwdriver :

- For use with phillips head screws

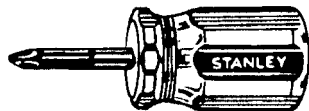

Item #	UM	O/A Length	Blade Len.	Blade Dia.	Point Size
M20643	Each	6-3/4"	3"	3/16"	#2

Pocket Screwdriver :

- With pocket clip
- Slotted pictured
- Phillips (not pictured)

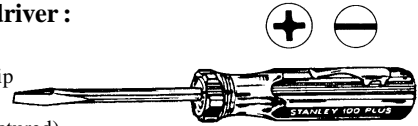

Item #	UM	O/A Length	Blade Len.	Blade Dia.	Tip
M20661	Each	4-3/8"	2"	1/8"	1/8" slot
M20662	Each	4-3/8"	2"	1/8"	#0 phil.

Square Blade / Standard Tip Screwdriver :

- Slotted tip
- Bolster blade for maximum strength



Item #	UM	O/A Length	Blade Len.	Blade Dia.	Tip Width
M20715	Each	8-3/4"	4"	1/4"	1/4"
M20706	Each	17-1/4"	12"	3/8"	1/2"

Standard Blade / Cabinet Tip Screwdriver :

- Slotted tip

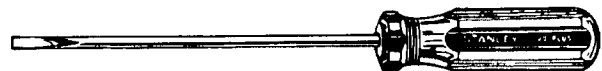

Item #	UM	O/A Length	Blade Len.	Blade Dia.	Tip Width
M20724	Each	6-3/4"	3"	3/16"	3/16"

Phillips Tip Screwdriver :

- For use with phillips head screws

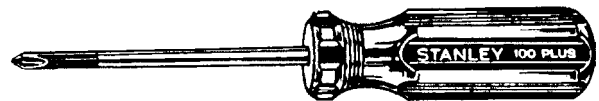

Item #	UM	O/A Length	Blade Len.	Blade Dia.	Point Size
M20607	Each	6-3/4"	3"	3/16"	#1
M20616	Each	8-1/4"	4"	1/4"	#2
M20625	Each	11"	6"	5/16"	#3
M20634	Each	13-1/4"	8"	3/8"	#4



MILL SUPPLY CO., INC.

Phone (410) 485-3343
Fax (410) 325-2240

Toll Free 1-800-817-8183

Tools

FASTENING TOOLS

6pc Screwdriver Set :

- High efficiency, high torque handle
- Round shaft
- Bright zinc plated blade to prevent corrosion
- Tool steel shafts for strength and durability
- Includes; 1/ea 3/16"x3", 3/16"x6", 1/4"x4", 1/4"x6" slotted 1/ea 1pt. x 4", 2pt. x 4" phillips



Item # M24313
U/M - Set

Crescent®

6 In 1 "T" Handle Screwdriver :

- "T" handle increases torque
- Interchangeable bits
- Ratchet action means that you do not have to reposition bit into screw openings
- Includes; 1/ea

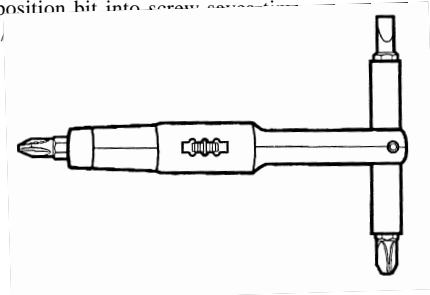

Crescent®

4 In 1 Screwdriver :

- Plastic handle
- 5/16" hex shaft
- Includes; 1/ea 1/4" x 3/16" slotted bit 1/ea #1 x #2 phillips bit

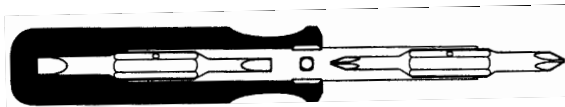

Item # M21748
U/M - Each

6pc Jewelers Screwdriver Set :

- Six precision screwdrivers feature swivel-head handles
- Bright plated shafts fluted for better grip
- Hardened and tempered steel blades with blued finish to resist corrosion
- Includes plastic storage case to index tools
- Includes; 1/ea 0 and 1 point phillips 1/ea 1.4, 1.8, 2.3, 3.0 mm slotted

STANLEY®

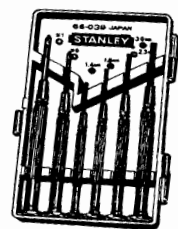

Item # M20652
U/M - Set

7pc Pro Nutdriver Set :

- Professional quality nut drivers
- Includes reusable plastic pouch
- Includes; 1/ea 3/16", 1/4", 5/16", 11/32", 3/8", 7/16", 1/2"
- 6" shaft, 9-1/2" length

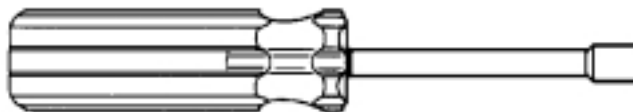

Item # M29176
U/M - Set

Scratch Awl / Ice Pick :

- Alloy steel bar anchored in hardwood handle by two wings stamped on the shank
- 6-1/16" length

STANLEY®

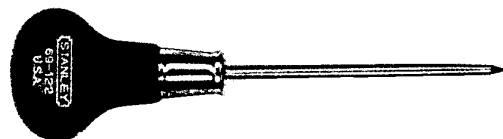

Item # M20733
U/M - Each



MILL SUPPLY CO., INC.

Phone (410) 485-3343
Fax (410) 325-2240

Toll Free 1-800-817-8183

Tools

Tools

FASTENING TOOLS

Phillips Insert Bit :

- 1/4" hex drive
- 1" length



Item #	U/M	Point Size
M29161	Each	#1
M29163	Each	#2
M29165	Each	#3

Phillips Power Bit :

- 1/4" hex drive



Item #	U/M	O/A Length	Point Size
M29151	Each	1-15/16"	#1
M29153	Each	1-15/16"	#2
M29155	Each	1-15/16"	#3
M29150	Each	2-3/4"	#1
M29157	Each	2-3/4"	#2
M29159	Each	2-3/4"	#3

Slotted Insert Bit :

- 1/4" hex drive
- 1-1/2" length



Item #	U/M	Size
M29167	Each	8F-10R
M29169	Each	10F-12R

Magnetic Bit Holder :

- 1/4" hex drive
- 3" length
- Holds bit securely in place
- For 1/4" hex drive bits



Item # M29173
U/M - Each

Magnetic Nut Setter :

- 1/4" hex drive
- 1-3/4" length

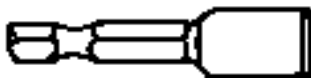

Item #	U/M	Size
M29140	Each	3/16"
M29141	Each	1/4"
M29143	Each	5/16"
M29145	Each	3/8"
M29147	Each	7/16"

Double End Bit :

- 1/4" hex drive
- 2" length
- #2 phillips x #8 slotted

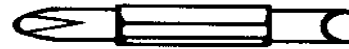

Item # M29170
U/M - Each



MILL SUPPLY CO., INC.

Phone (410) 485-3343
Fax (410) 325-2240

Toll Free 1-800-817-8183

Tools

FASTENING TOOLS

9pc Folding Hex Key Set :

- Keys fold neatly and securely into convenient storage case
- Heat treated alloy steel for longer life
- 9pc English set includes; 1/ea 5/64", 3/32", 7/64", 1/8", 9/64", 5/32", 3/16", 7/32", 1/4"

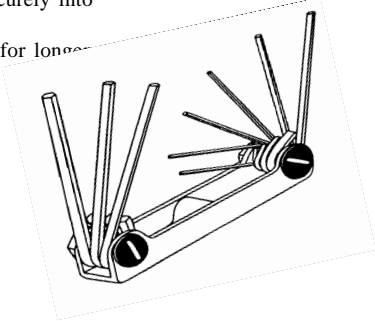

Item # M20742
U/M - Each



12 In 1 Pocket Tool :

- Stainless steel
- Plastic coated handles
- Contains: Long nose pliers / Small knife Wire cutters / Large knife Can opener / Awl-Hole punch Phillips screwdriver / Slotted driver (S) Fish scaler / Slotted driver (M) Hook remover / Slotted driver (L)
- Includes belt pouch

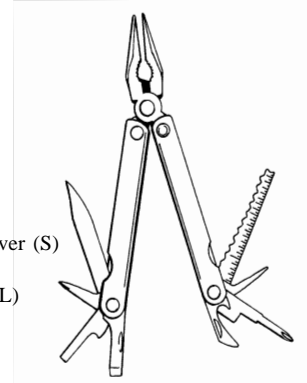

Item # M20811
U/M - Each

Adjustable Wrench :

- For professional, industrial, or home use
- Wide capacity jaw
- Wider handle provides more comfort and less stress to the hand
- Tension spring stabilizes jaw and adjusts easily
- Plated finish resists rust and corrosion



Item #	U/M	Length
M24511	Each	6"
M24512	Each	8"
M24513	Each	10"
M24519	Each	12"

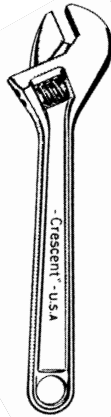

Straight Jaw Locking Plier :

- Compound action for powerful non-slip locking grip
- Convenient, quick, one hand release lever
- Accurate adjustments with screw machined ferrule
- Plated finish
- Lifetime warranty

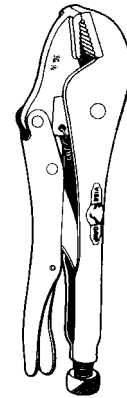

Item #	U/M	Length
M23548	Each	7"
M23550	Each	10"

Curved Jaw Locking Plier :

- Compound action for powerful non-slip locking grip
- Convenient, quick, one hand release lever
- Accurate adjustments with screw machined ferrule
- Plated finish
- Built in wire cutter
- Lifetime warranty

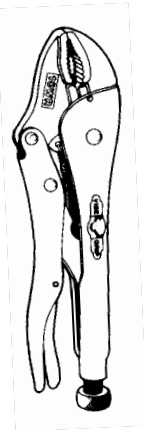

Item #	U/M	Length
M23549	Each	7"
M23551	Each	10"

Locking "C" Clamp :

- Swivel pads on jaws protect surfaces
- Convenient, one-hand quick release lever
- Plated finish
- Lifetime warranty

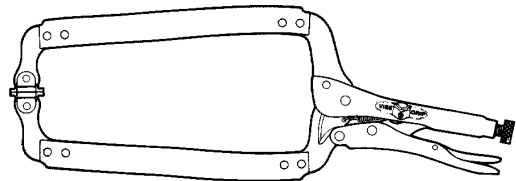

Item #	U/M	Length
M23560	Each	6"
M23561	Each	11"



MILL SUPPLY CO., INC.

Phone (410) 485-3343
Fax (410) 325-2240

Toll Free 1-800-817-8183

Tools

FASTENING TOOLS

Straight Jaw Tongue & Groove Plier :

- Made from finest quality tool steel
- Designed to grip all shapes like rods, pipes and cable connections
- Precision-milled ribs assure smooth, positive interlock between jaws separating or jumping
- Straight jaws and
- Forged, hardened
- Black phosphor
- Red non-slip

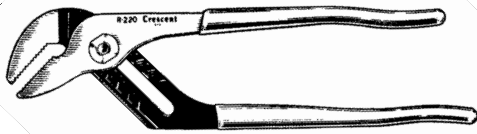

Item #	U/M	Length
M24627	Each	10"
M24614	Each	12"



Box Joint Plier :

- Laminated / riveted construction for the toughest jobs
- Textured air cushioned grips provide excellent hand contact and comfort
- Multiple position jaw provides flexibility for a wide range of applications
- Box joint design has less chance of slippage compared to conventional tongue and groove pliers
- 8" plier has 1-1/2" jaw capacity
- 10" plier has 1-3/4" jaw capacity

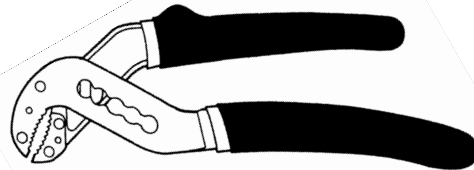

Item #	U/M	Length
M24509	Each	8"
M24510	Each	10"



Combination Slip Joint Plier :

- Designed for gripping and turning round objects such as pipes, rods and pins
- Curved jaws combination with machined gripping teeth and wire cutter
- Forged from carbon steel accurately machined, hardened and
- Bright, plated finish
- Red non-slip cushion

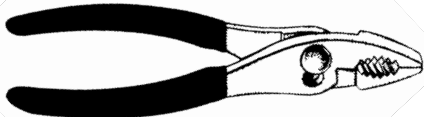

Item #	U/M	Length
M24591	Each	6-1/2"
M24609	Each	8"



6 Point Socket Set :

- Professional industrial quality
- **3/8" fractional drive set** includes; reversible ratchet, 3" and 6" extensions, six point sockets; 3/8", 7/16", 1/2", 9/16", 5/8", 11/16", 3/4", 13/16", 7/8" Deep six point sockets; 3/8", 7/16", 1/2", 9/16", 5/8", 11/16", 3/4", 13/16"-**20pc set**
- **3/8" metric set** (not pictured) includes; reversible ratchet, 8-1/2" flex handle drive, 3" and 6" extensions, six point sockets; 7-19mm, 5/8" spark plug socket-**18pc set**
- Both sets include plastic tool case

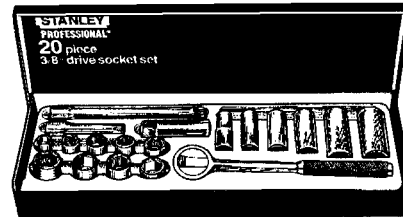

Item # M20799
U/M - Set
3/8" Fractional Drive

Item # M20798
U/M - Set
3/8" Metric Drive



MILL SUPPLY CO., INC.

Phone (410) 485-3343
Fax (410) 325-2240

Toll Free 1-800-817-8183

Tools

Tools

FASTENING TOOLS

Straight Pipe Wrench :

- The original heavy-duty pipe wrench
- Sturdy cast-iron housing and I-beam handle for comfortable grip and strength without excess weight
- Rugged, easy-spin, non-stick adjustment nut that automatically cleans grime from hook jaw shank
- Uniquely braced, extra-strong mount for heel jaw
- Uncompromising Ridge Tool Co. quality product designed to provide many years of dependable use

RIDGID



Item #	UM	Size	Capacity
M21816	Each	6"	3/4"
M21820	Each	8"	1"
M21824	Each	10"	1-1/2"
M21828	Each	12"	2"
M21832	Each	14"	2"
M21836	Each	18"	2-1/2"
M21840	Each	24"	3"

T-50 Staple Gun :

ARROW

- Powerful compression spring action drive
- For hard woods, plywood, composition board, plastics and soft metals
- All steel construction
- All chrome finish
- Double leverage mechanism allows easy operation with minimum squeeze pressure

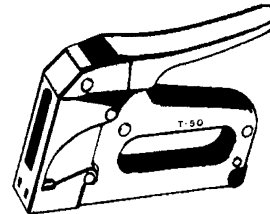

Item # M29132
U/M - Each

Staples :

ARROW

- For use with our #M29132 staple gun



Item #	UM	Size	Quantity
M29126	Pack	1/4"	1250/pk
M29127	Pack	5/16"	1250/pk
M29128	Pack	3/8"	1250/pk
M29129	Pack	1/2"	1250/pk
M29130	Pack	9/16"	1250/pk

Hot Melt Glue Gun :

ARROW

- For woodworking, ceramics, leather, canvas, fabric, cardboard, plastics, metals, etc.
- For fine detail work
- Controls glue flow

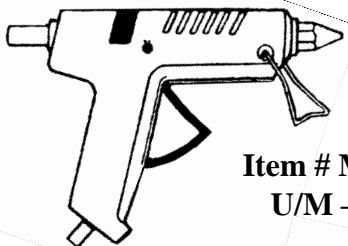

Item # M29134
U/M - Each

All Purpose Glue Sticks :

ARROW

- Fits our #M29134 glue gun
- For crafts, hobbies, and general repair
- Sets in 30-60 seconds
- 6 sticks 4" length
- Clear in color



Item # M29135
U/M - Pack

Spring Clamp :

STANLEY

- Heavy gauge steel with vinyl grips and tips to prevent marring work
- Jaws specially formed to hold flat or round objects
- 4-1/16" length
- 7/8" jaw opening

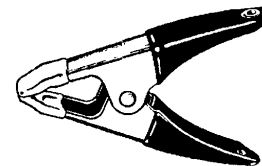

Item # M20751
U/M - Each



MILL SUPPLY CO., INC.

Phone (410) 485-3343
Fax (410) 325-2240

Toll Free 1-800-817-8183

Tools

POWER TOOLS

9.6V Cordless Drill / Driver Set :

- Multi-position adjustable clutch for screwdriving accuracy
- Compact and lightweight: only 3.6lbs.
- 1,100 rpm
- 200 in/lbs. Max torque
- Includes: 1ea 1 hour battery charger, 2ea compact batteries, 1ea kit box

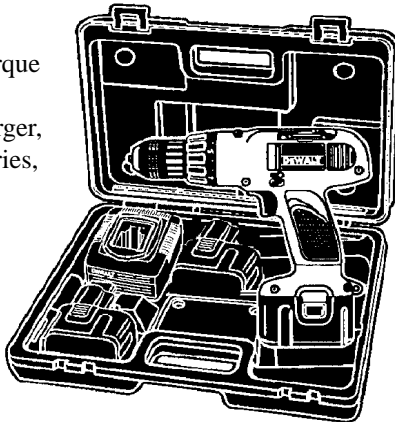

Item # M26314
U/M - Each



12V 3/8" Cordless Drill / Driver Set :

- Multi-position adjustable clutch for screwdriving accuracy
- Compact and lightweight: only 3.8lbs.
- 1,200 rpm / 190 in/lbs. Max torque
- Includes: 1ea 1 hour battery charger, 2ea compact batteries, 1ea kit box

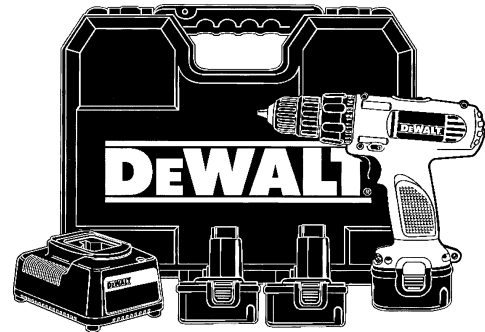

Item # M26335
U/M - Each



Heavy-Duty 18V Cordless 3/8" Adjustable Clutch Drill/Driver Kit :

- Compact & lightweight; 4.8lbs
- Multi-position adjustable clutch for screwdriving accuracy
- Kit includes: 1 ea 1 hour battery charger, 2 ea compact batteries, screwdriver bit, and kit box

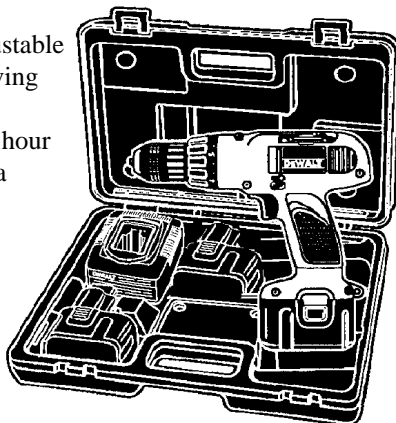

Item # M25049
U/M - Each



Heavy-Duty 24V 1/2" Cordless Drill/ Hammerdrill Kit :

- Variable speed, reversing
- Factory-set clutch reduces sudden, high torque reactions if bit jams
- Electro-pneumatic hammer mechanism for fast penetration and low vibration
- 360 degree side handle
- Kit includes: 1 ea 1 hour charger, 1ea compact battery, side handle, and kit box

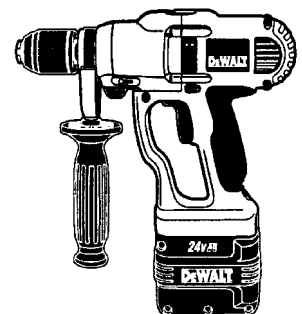

Item # M25047
U/M - Each



MILL SUPPLY CO., INC.

Phone (410) 485-3343
Fax (410) 325-2240

Toll Free 1-800-817-8183

Tools

POWER TOOLS

Heavy-Duty 3/8" VSR Drill :



- Heavy-duty keyless chuck provides greater bit retention
- Built-in two-way level for drilling accurate vertical and horizontal holes
- Contoured textured handle for better grip
- All ball-bearing construction provides greater durability
- 5.4 Amps; 0-2,500 rpm
- Weighs only 3.3 lbs

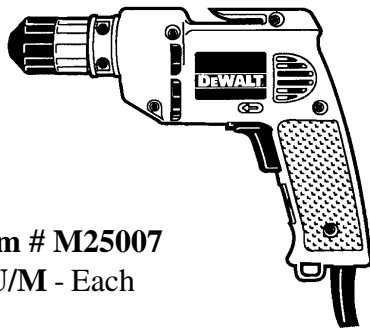

Item # M25007
U/M - Each

Heavy-Duty 3/8" VSR Drill :



- Heavy-duty keyless chuck with spindle lock which ensures maximum holding power and superior slip resistance greater than or equal to keyed systems
- Helical-cut steel, heat treated gears for smooth operation
- Contoured textured handle for better grip
- 6.7 Amps; 0-1,200 rpm
- Weighs only 3.3 lbs

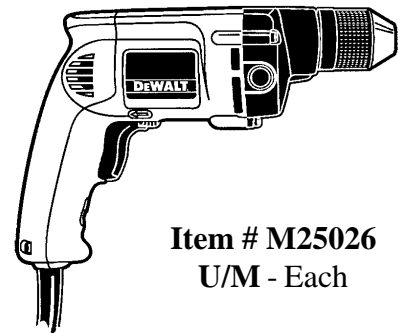

Item # M25026
U/M - Each

Heavy-Duty VSR Deck/Drywall Screwdriver :



- 6.2 Amps; 0-2,500 rpm
- Helical-cut, heat treated gears for smooth operation
- High torque for deck building or drywall
- Depth-sensitive, "set and forget" nosepiece for consistent fastener depth
- Two-finger, rubber trigger for increased comfort

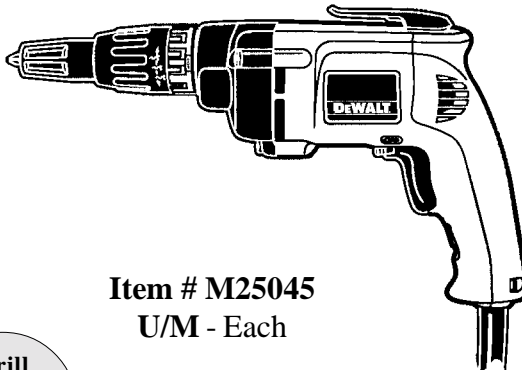

Item # M25045
U/M - Each

Heavy-Duty 1/2" VSR Hammerdrill Kit :



- High power motor for greater durability
- Dual mode: Hammer/drill for wood, steel or masonry applications
- Lightweight design for less user fatigue
- Two-finger rubber trigger for increased comfort
- Kit includes: side handle, depth rod, kit box

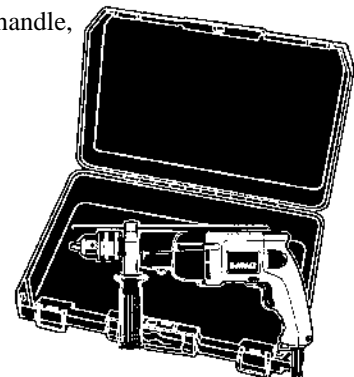

Item # M25053
U/M - Each

Drill
Bits
Page 45-53



MILL SUPPLY CO., INC.

Phone (410) 485-3343
Fax (410) 325-2240

Toll Free 1-800-817-8183

Tools

POWER TOOLS

Heavy-Duty 7-1/4" Circular Saw :

- 15.0 Amps
- High-strength, low-friction aluminum alloy shoe
- Lightweight; 10.9 lbs.
- 100% ball and roller bearings
- 50 degree bevel capacity
- Shoe provides a 1-1/2" edge distance that matches dimensional lumber thickness
- Includes a 20-tooth carbide blade and wrench

Circular
Saw Blades
Page 59

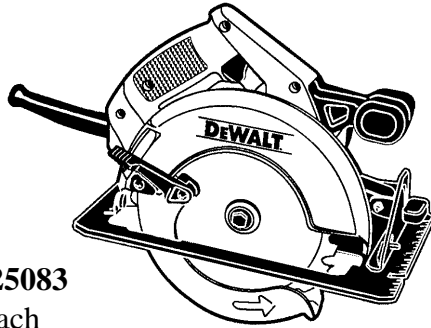

Item # M25083
U/M - Each



Heavy-Duty 18V Cordless 5-3/8" Trim Saw Kit :

- Cuts 2X materials in a single pass
- Left side blade provides maximum visibility
- Replaceable brushes for longer motor life
- DeWALT-built high-performance motor with fan cooling delivers maximum power and durability
- Kit includes: DW9116 charger, DW9096 XR+ PACK battery, 5-3/8" 16-tooth carbide saw blade, blade wrench, and kit box

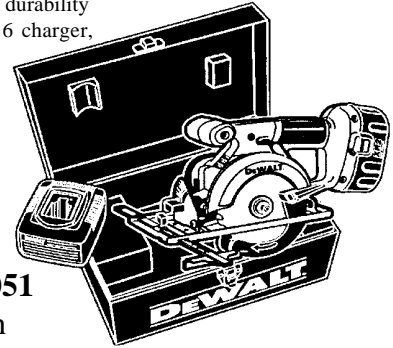

Item # M25051
U/M - Each



Heavy-Duty Reciprocating Saw Kit :

- 6.5 Amps
- Variable speed, 0-2,400 rpm
- 1-1/8" stroke length
- Compact and lightweight; only 6.5 lbs
- 100% ball and roller bearings
- Includes; assorted blades, wrench holder and Allen wrench and kit box

Reciprocating
Saw Blades
Page 61

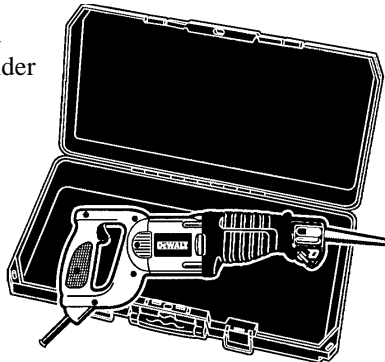

Item # M25064
U/M - Each



Heavy-Duty 1/4" Sheet Palm Grip Sander :

- 2.0 Amp motor moves at 13,500 opm, providing a superior finish
- Counter-balanced low-vibration design reduces user fatigue
- Dust-sealed switch for increased durability
- Sealed 100% ball-bearing construction provides longer life
- Dust bag and sandpaper pouch included
- Weighs only 2.3lbs

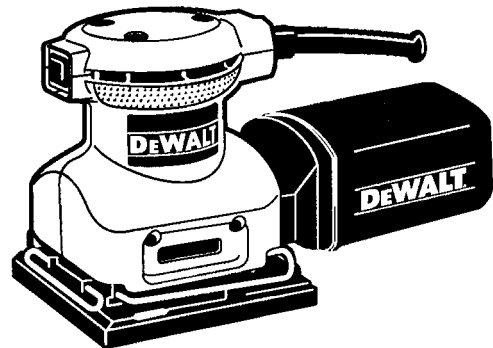

Item # M25102
U/M - Each



MILL SUPPLY CO., INC.

Phone (410) 485-3343
Fax (410) 325-2240

Toll Free 1-800-817-8183

Page 93

Tools

POWER TOOLS

Heavy-Duty 4-1/2" Small Angle Grinder :

DEWALT

- 2-position removable side handle for greater comfort and control
- Sliding switch for extended use applications
- Lightweight; 4.5lbs
- Includes depressed center wheel, wrench, backing flange, clamp nut and guard

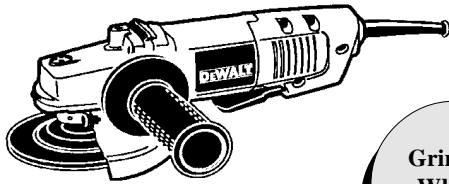

Grinding
Wheels
Page 23

Item # M25057
U/M - Each

Heavy-Duty Jig Saw :

DEWALT

- Variable speed trigger allows the user to match the blade speed with the application
- 4.5 Amps, 0-3100 strokes/min

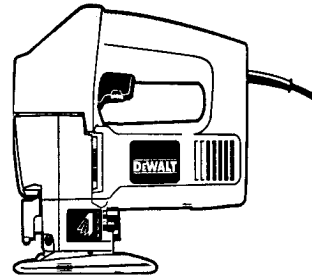

Jig
Saw Blades
Page 62

Item # M25055
U/M - Each

Heavy-Duty 12" Cut-Off Machine :

DEWALT

- Switch and motor are protected from abrasive dust by exclusive filtering system
- Adjustable guard for different cutting depths is mounted at two points to maintain proper alignment
- Rotation throws sparks and debris away from the operator and helps prevent climbing in the cut
- Handle place for lifting a tool centerline to prevent tilting

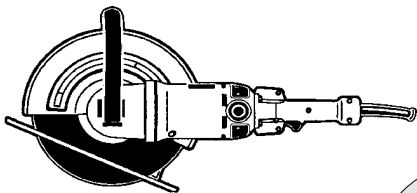

Cutoff
Wheels
Page 23

Item # M25059
U/M - Each

Heavy-Duty 18/14 Gauge Swivel Head and Shear :

DEWALT

- Head Swivels 360 degrees for cutting convenience
- Cuts 7/32" strip which continuously curls out of cutting area
- Variable speed permits cutting of a wide variety of thickness
- Cuts radius of 5-1/2" and larger



Item # M25061
U/M - Each



MILL SUPPLY CO., INC.

Phone (410) 485-3343
Fax (410) 325-2240

Toll Free 1-800-817-8183

Hardware

Hardware



MILL SUPPLY CO., INC.

Phone (410) 485-3343
Fax (410) 325-2240

Toll Free 1-800-817-8183

Hardware

BATHROOM HARDWARE

Ceramic
Bath
Hardware
Page 165

Retractable Clothesline :

- Surface mounted w/concealed screw application
- Includes mounting plate w/ screws
- Cover up unit is polished stainless steel
- Unit is 3-5/8" diameter, 9' cord length

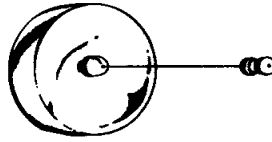

Item # M34706
U/M - Each

Soap Dish :

- Surface mounted with concealed screw application
- Includes mounting plate and screws
- Die cast zinc alloy
- 4" wide x 3" deep

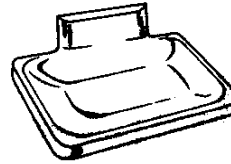

Item #	U/M	Description
M34568	Each	Chrome
M34571	Each	Brass

Toothbrush/Tumbler Holder :

- Surface mounted w/concealed screw application
- Includes mounting plate and screws
- Die cast zinc alloy
- 4" wide x 3" deep

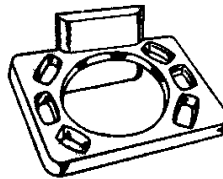

Item #	U/M	Description
M34639	Each	Chrome
M34641	Each	Brass

Paper Holder & Roller :

- Surface mounted w/concealed screw application
- Includes mounting plates and screws
- Post die cast zinc alloy
- White plastic roller
- 6-1/2" center to center

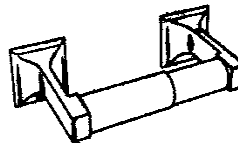

Item #	U/M	Description
M34596	Each	Chrome
M34603	Each	Brass

* Replacement roller Item # M34615

Recessed Paper Holder :

- Die cast zinc alloy
- Roller is white plastic w/spring tension
- Wall opening need: 5" W x 5-1/4" H

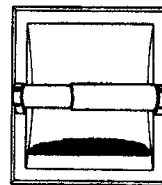

Item # M34599
U/M - Each

* Replacement roller Item # M34615

Installation Clamp :

- Used for all screw mounted recessed fixtures



Item # M34665
U/M - Each



MILL SUPPLY CO., INC.

Phone (410) 485-3343
Fax (410) 325-2240

Toll Free 1-800-817-8183

Hardware

Ceramic
Bath
Hardware
Page 165

BATHROOM HARDWARE

Towel Bars :

- Chrome alloy finish
- 3/4" square
- Posts not included



Item #	U/M	Size
M34511	Each	24" x 3/4"
M34513	Each	36" x 3/4"

Towel Bar Posts :

- Die cast zinc alloy
- Includes mounting plates and screws
- For 3/4" square bars
- Protrudes 3" from the wall



Item # M34544
U/M - Pair

Towel Bars Sets :

- High quality die cast posts
- Concealed screw application
- Includes mounting plates and screws
- 3/4" square



Item #	U/M	Size	Description
M34518	Each	18"	Chrome
M34527	Each	24"	Chrome
M34535	Each	30"	Chrome
M34537	Each	36"	Chrome
M34524	Each	18"	Brass
M34530	Each	24"	Brass

Towel Ring :

- Chrome finish
- Surface mounted w/concealed screw application
- Includes mounting plate and screws
- 6" diameter ring

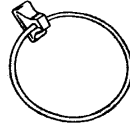

Item # M34657
U/M - Each

Double Robe Hook :

- Chrome finish
- Surface mounted w/concealed screw application
- Includes mounting plate and screws



Item # M34683
U/M - Each

1-1/2" White Finish Grab Bars :

- 18 ga. type 304 SS tubing
- Powder coated white finish
- concealed screw
- Poly bagged w/screws

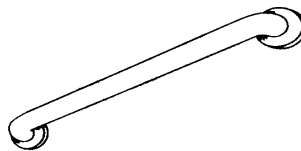

Item #	U/M	Size
M38552	Each	24"
M38553	Each	30"
M38554	Each	36"
M38556	Each	42"

1-1/2" Stainless Steel Grab Bars :

- 18 ga. type 304 SS tubing
- Exposed screw
- Poly bagged w/screws

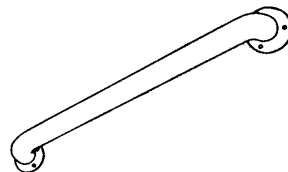

Item #	U/M	Size
M38504	Each	18"
M38506	Each	24"
M38508	Each	30"
M38510	Each	36"
M38512	Each	42"
M38514	Each	48"



MILL SUPPLY CO., INC.

Phone (410) 485-3343
Fax (410) 325-2240

Toll Free 1-800-817-8183

Hardware

Hardware

MEDICINE CABINETS

Medicine Cabinet :

- 16" x 22" overall dimensions
- Polystyrene cabinet body
- 2 fixed shelves, plastic
- Stainless steel frame around cabinet mirror
- Recessed mount (14"x18" R.O.)

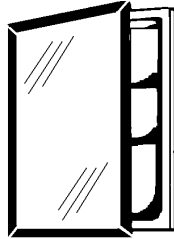

Item # M38657
U/M - Each

Medicine Cabinet :

- 16" x 22" overall dimensions
- Polystyrene cabinet body
- 2 fixed shelves, plastic
- Stainless steel frame around cabinet mirror
- Surface mount

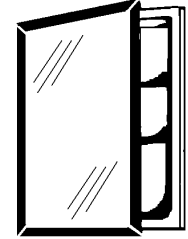

Item # M38659
U/M - Each

Medicine Cabinet :

- 16" x 22" overall dimensions
- Polystyrene cabinet body
- 2 adjustable shelves, metal
- Beveled edge mirror
- Recessed mount (14"x18" R.O.)

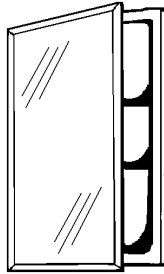

Item # M38733
U/M - Each

Medicine Cabinet :

- 16" x 22" overall dimensions
- Polystyrene cabinet body
- 2 adjustable shelves, plastic
- Polished, pencil edge mirror
- Recessed mount (14"x18" R.O.)

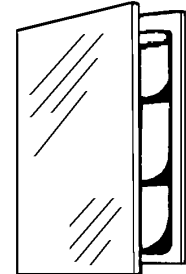

Item # M38656
U/M - Each

Medicine Cabinet :

- 16" x 26" overall dimensions
- Polystyrene cabinet body
- 3 adjustable shelves, plastic
- Beveled edge mirror
- Recessed mount (14"x24" R.O.)

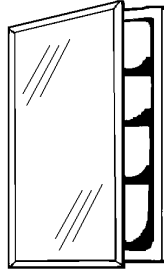

Item # M38814
U/M - Each

Side Medicine Cabinet :

- M38673 features; beveled edge mirror, recessed mount polystyrene body and plastic shelves (10"x34" R.O.)
- M38688 features; pencil edge mirror, flush mount, metal body and metal shelves

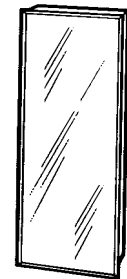

Item #	U/M	Size	Mount
M38673	Each	12" x 36" x 3"	Recessed
M38688	Each	12-1/4" x 34" x 3-1/2"	Flush

Slider Bath Cabinet :

- Steel cabinet
- Surface mount w/outlet
- 2 metal fixed shelves

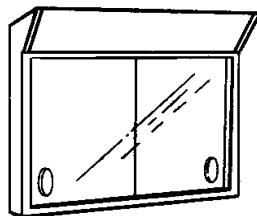

Item #	U/M	Size (WxH)
M38811	Each	24" x 19"
M38829	Each	28" x 19"

Cosmetic Boxes :

- Stainless steel body
- Surface mount

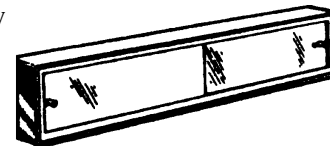

Item #	U/M	Size
M38929	Each	24"
M38932	Each	30"
M38935	Each	36"
M38938	Each	48"

Medicine Cabinet Diffusers
Page 246



MILL SUPPLY CO., INC.

Phone (410) 485-3343
Fax (410) 325-2240

Toll Free 1-800-817-8183

Hardware

MEDICINE CABINET / MIRROR ACCESSORIES

Medicine Cabinet Shelf :

- Clear plastic
- Fits cabinets with polystyrene body only
- Fits our cabinets, #M38657, M38659, M38656 and M38814

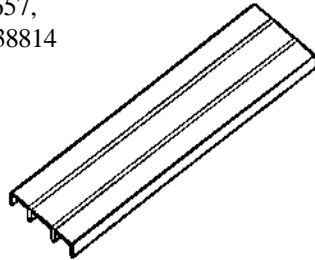

Item # M38916
U/M - Each

Medicine Cabinet Track :

- 36" Length
- Can be cut to length
- Made of durable plastic
- Replaces top and/or bottom track

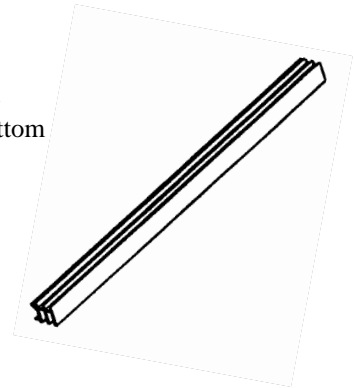

Item # M38914
U/M - Each

Mirror Pull :

- Chrome finish
- Made of high durable plastic
- Adhesive backing
- Sold by the each



Item # M35863
U/M - Each

Mirror Clip :

- Made of clear plastic to match any decor
- Screw included
- For use on 3/16" & 1/4" mirrors

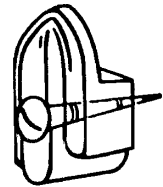

Item # M35869
U/M - Each

J-Bar :

- For use with 3/16" or 1/4" mirrors
- Used as lower channel
- Available in chrome or Brass finish
- Sold by the foot



Item #	U/M	Finish
M35851	Feet	Chrome
M35853	Feet	Brass

High Hat J-Bar :

- For use with 3/16" or 1/4" mirrors
- Used as upper channel
- Available in chrome or Brass finish
- Sold by the foot



Item #	U/M	Finish
M35855	Feet	Chrome
M35857	Feet	Brass



MILL SUPPLY CO., INC.

Phone (410) 485-3343
Fax (410) 325-2240

Toll Free 1-800-817-8183

Hardware

MIRRORS

1/8" Mirror :

- Pencil edge
- Used mainly for replacing medicine cabinet glass

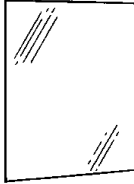

Item #	U/M	Size
M35564	Each	12" x 15"
M35568	Each	12" x 18"
M35582	Each	14" x 15"
M35591	Each	14" x 18"
M35600	Each	16" x 22"

3/16" Mirror :

- Pencil edge

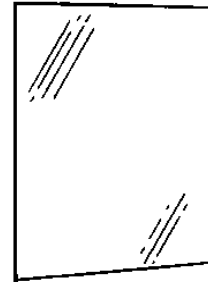

Item #	U/M	Size
M35562	Each	12" x 15"
M35569	Each	12" x 18"
M35590	Each	14" x 18"
M35639	Each	24" x 24"
M35643	Each	24" x 30"
M35648	Each	24" x 36"
M35652	Each	24" x 42"
M35656	Each	24" x 48"
M35668	Each	29" x 42"
M35672	Each	30" x 30"
M35676	Each	30" x 36"
M35679	Each	30" x 48"
M35684	Each	35" x 36"
M35700	Each	36" x 48"
M35708	Each	36" x 54"
M35716	Each	36" x 60"
M35732	Each	42" x 35"
M35744	Each	42" x 47"
M35750	Each	42" x 52"
M35752	Each	42" x 54"
M35756	Each	42" x 58"
M35768	Each	42" x 66"
M35780	Each	42" x 70"
M35784	Each	42" x 72"

1/4" Mirror :

- Pencil edge

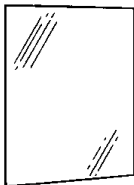

Item #	U/M	Size
M35616	Each	18" x 30"
M35796	Each	42" x 82"
M35809	Each	42" x 91"
M35813	Each	42" x 96"
M35817	Each	48" x 96"

Oval Mirror :

- 24" x 36" with 1/2" oval beveled edge perimeter



Item # M35647
U/M - Each

*** We will cut & sand mirrors to your specifications for a nominal charge. Contact your sales representative for more information**



MILL SUPPLY CO., INC.

Phone (410) 485-3343
Fax (410) 325-2240

Toll Free 1-800-817-8183

Hardware

WINDOW BALANCES

Window Balances :

- 9/16" wide, 5/8" deep
- Style "G"

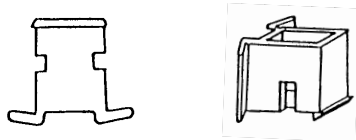

Top View



Bottom View

* The letter of the stamp indicates the weight strength of the balance :
 A = 10lb. sash
 B = 20lb. sash
 C = 30lb. sash

Item #	U/M	Stamped	Letter*	Length
M39258	Each	# 1610	16A	17"
M39266	Each	# 1620	16B	17"
M39270	Each	# 1710	17A	18"
M39274	Each	# 1810	18A	19"
M39282	Each	# 1820	18B	19"
M39290	Each	# 1840	18D	19"
M39298	Each	# 1910	19A	20"
M39306	Each	# 1940	19D	20"
M39314	Each	# 2010	20A	21"
M39322	Each	# 2020	20B	21"
M39330	Each	# 2110	21A	22"
M39338	Each	# 2210	22A	23"
M39346	Each	# 2220	22B	23"
M39354	Each	# 2230	22C	23"
M39362	Each	# 2310	23A	24"
M39370	Each	# 2410	24A	25"
M39378	Each	# 2420	24B	25"
M39386	Each	# 2430	24C	25"
M39394	Each	# 2510	25A	26"
M39402	Each	# 2520	25B	26"
M39410	Each	# 2620	26B	27"
M39418	Each	# 2810	28A	29"
M39426	Each	# 2820	28B	29"

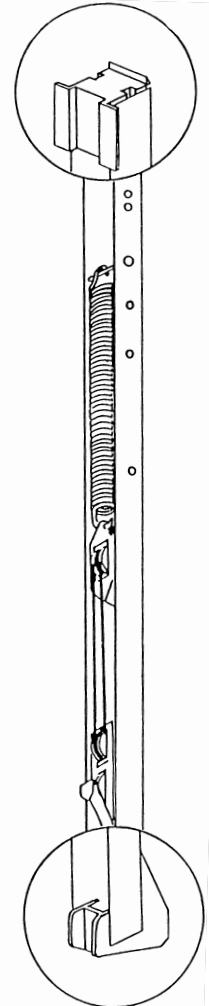

How to order window balances correctly

1. Verify that the ends on your window balance match the ends of *our* window balances. (If they do go to step 2) (If they do not go to step 3)
2. Look for a stamped number or letter that matches the above chart. (If they do go to step 4) (If no stamp or letter is visible go to step 3)
3. Measure the length of the metal balance, not tips. Then match the length to above chart. (If your length is in the above chart go to step 4) (If not go to step 5)
4. Order using our Mill Supply item number.
5. This is not a standard window balance we stock, please call our inside sales department and we will assist you further.

Window Balance Clip :

- Take out clip for window balance
- 1-1/4" x 1/4"
- Sold by the each

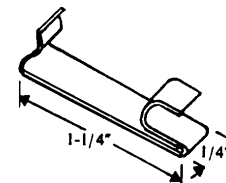

Item # M39831
 U/M - Each



MILL SUPPLY CO., INC.

Phone (410) 485-3343
 Fax (410) 325-2240

Toll Free 1-800-817-8183

Hardware

WINDOW HARDWARE

Corner Insert :

- Die cast

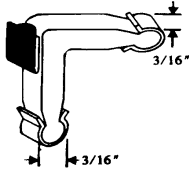

Item # M39825
U/M - Each

Corner Insert :

- Die cast

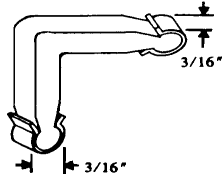

Item # M39823
U/M - Each

Window Rollers :

- Metal with 9/16" diameter roller

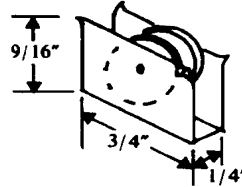

Item # M39478
U/M - Each

Sash Lock :

- Brass finish
- Two piece die cast
- Screws included

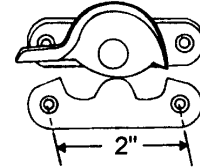

Item # M39468
U/M - Each

Patio Door Security Bar Hardware Kit :

- Includes hinge bracket, plastic socket bracket, and screws
- Sold as a complete set only

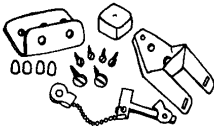

Item # M39991
U/M - Each

Sliding Lock :

- Fits all sliding metal door and window frames
- Excellent safety track lock
- Extruded aluminum mill finish
- Thumb screw locking
- Allows for various vent openings

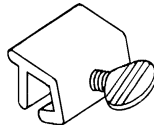

Item # M39482
U/M - Each

Nite Lock Pins :

- For sliding aluminum patio doors
- Knurled head
- 1/4" Diameter pin
- Case hardened
- Furnished with nickel plated chain, hanger bracket and screw
- Chrome finish

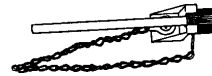

Item #	U/M	Length
M39492	Each	3-1/2"
M39493	Each	4-1/4"

Storm Door Clips :

- For screens and storm doors
- Threaded clips with knurled thumb screws
- Standard reach
- Pack of 8 clips & 8 screws



Item # M39680
U/M - Pack

Patio Door Security Bar :

- Fits 36" to 48" doors
- Plated steel hinge bracket, durable plastic end
- Aluminum finish

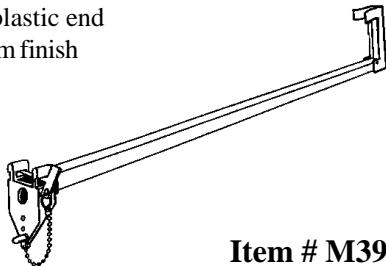

Item # M39977
U/M - Each

Screen Wire :

- Sold in rolls of 100'

Spline
Rollers &
Spline
Page 106



Item #	U/M	Description	Width
M39517	Roll	Gray Fiberglass	36"
M39519	Roll	Gray Fiberglass	48"
M39526	Roll	Charcoal Fiberglass	36"
M39528	Roll	Charcoal Fiberglass	48"
M39529	Roll	Charcoal Fiberglass	60"
M39507	Roll	Bright Aluminum	36"
M39509	Roll	Bright Aluminum	48"



MILL SUPPLY CO., INC.

Phone (410) 485-3343
Fax (410) 325-2240

Toll Free 1-800-817-8183

Hardware

BUILDERS HARDWARE

Steel Adjustable Patio Screen Doors :

- Replaces 90% of existing patio screen doors
- Easy access field adjustments for quick installation
- Comes with heavy duty top and bottom expanders that allow the doors to adjust from 78-1/2" to 80" for a custom fit
- Release the four wheels by turning side screws until wheel pops free, for quiet smooth rolling action
- Tear away vinyl bug flap is designed for hand peeling to custom fit your door
- Reversible for right or left hand doors
- Complete with latch, door pull, keeper, nylon rollers, bug strip and instructions
- Patio doors are 1/2" thick, except at the side expander which is 5/8" thick
- Made of .020 gauge rollform steel

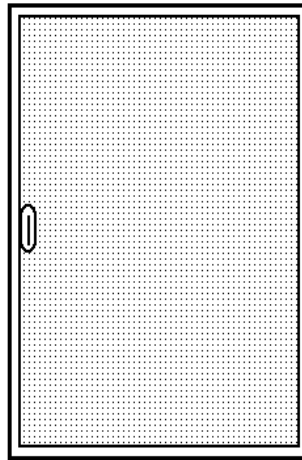

Item #	Finish	Width
M39880	Mill	36"
M39881	White	36"
M39879	Bronze	36"
M39966	Mill	48"
M39967	White	48"
M39965	Bronze	48"

Patio Door Handle :

- 9-3/4" Overall length
- 6-5/8" Hole centers
- All metal, one piece construction
- Chrome finish
- Screws included

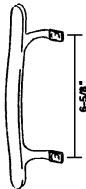

Item # M39760
U/M - Each

Patio Door Handle :

- 10" Overall length
- 6-5/8" Hole centers
- Zinc die cast mounting brackets
- Weather resistant finish
- Fits most patio doors
- Screws included



Item # M39762
U/M - Each

Patio Door Handle :

- 9" Overall length
- Aluminum finish with wood grain handle
- 3-15/16" Hole centers
- Includes all mounting hardware

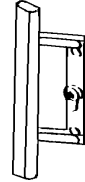

Item # M39768
U/M - Each

Patio Door Keepers :

- Chrome finish
- Fits most patio locks
- With screws

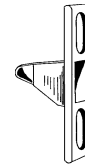

Item #	U/M	Width
M39776	Each	3/4"
M39788	Each	1/2"

Patio Door Locks :

- 6-5/8" Hole centers
- Fits 7" cutout
- Chrome finish
- With screws and standard lock keeper

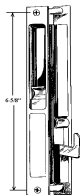

Item # M39764
U/M - Each

Patio Door Key Plugs :

- Keyed different
- B-1 keyway
- 1" Plug length
- Wafer cylinder
- 1/8" Tailpiece



Item # M39774
U/M - Each

Patio Door Keepers :

- Replaces broken patio door keeper
- Made of durable black plastic
- Fits most patio doors

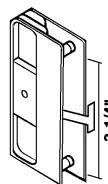

Item # M39772
U/M - Each

Patio Door Decal :

- Highly visible yellow color
- Keeps kids and pets from walking into a closed patio door
- 4-1/2" x 5"
- Sold per each



Item # M15720
U/M - Each



MILL SUPPLY CO., INC.

Phone (410) 485-3343
Fax (410) 325-2240

Toll Free 1-800-817-8183

Hardware

PATIO/SCREEN DOOR ACCESSORIES

Nylon Roller :

- 1" Nylon roller

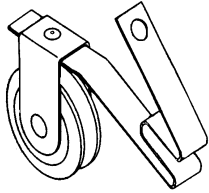

Item # M39748
U/M - Each

Nylon Roller :

- 1" Nylon roller
- 2-1/2" Length

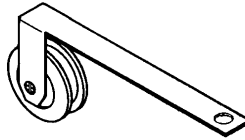

Item # M39754
U/M - Each

Nylon Roller :

- 1" Nylon roller

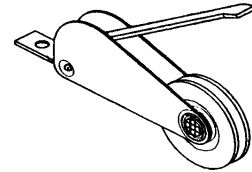

Item # M39756
U/M - Each

Nylon Roller :

- 1" Nylon roller
- 1-3/4" Length
- 9/32" Roller width

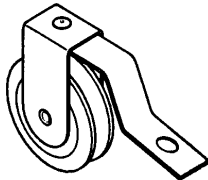

Item # M39750
U/M - Each

Metal Roller :

- 1" Metal roller
- 1-3/4" Length
- 9/32" Roller width

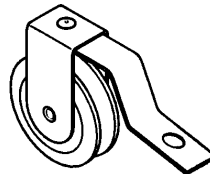

Item # M39829
U/M - Each

Metal Roller :

- 1" Metal roller

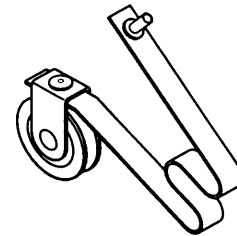

Item # M39752
U/M - Each

Storm Handle Door :

- Push button catch
- Anti lockout feature
- 1-3/4" Mounting hole spacing
- Installs in three 1/4" holes
- Fits outswing doors 7/8" - 1-1/4" Thick
- Black finish

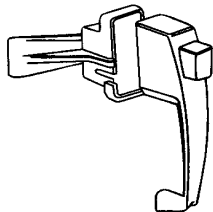

Item # M39674
U/M - Each

Pneumatic Door Closers :

- Positive latching mechanism
- Internal shock absorbing spring
- Provides 90 degree opening for outswing door
- Adjustable closing speed control valve
- Tube permanently lubricated and factory sealed
- 10-1/2" Length
- Black finish

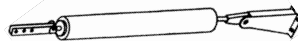

Item # M39682
U/M - Each

Hydraulic Storm Door Closer :

- Heavy duty
- Closing action not affected by temperature
- Provides 90 degree opening for outswing doors
- Adjustable closing speed control
- Permanently lubricated
- Black finish
- 10-1/2" Length

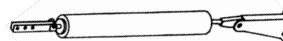

Item # M39654
U/M - Each

Storm Door Strikes :

- Fits all make storm door locks
- Resilient strike
- Fully adjustable
- Black finish

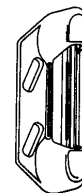

Item # M39699
U/M - Each



MILL SUPPLY CO., INC.

Phone (410) 485-3343
Fax (410) 325-2240

Toll Free 1-800-817-8183

Hardware

Hardware

WINDOW SCREEN ACCESSORIES

Spline Rollers :

- Used to apply spline to screen track
- Wood handle
- Includes convex and concave rollers

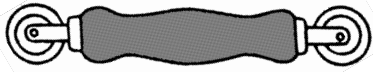

Item #	U/M	Description
M39578	Each	Metal rollers : both 2" diameter
M39581	Each	Metal rollers : both 1-1/2" diameter
M39579	Each	Plastic rollers : lea. 3", lea. 2" diameter

Spline :

- 1000' rolls
- Grey color

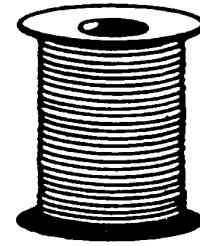

Item #	U/M	Diameter	Trade Diameter
M39553	Roll	.140	9/64"
M39555	Roll	.172	11/64"
M39558	Roll	.250	1/4"

Tension Springs :

- 3" flat tension spring used for window screens

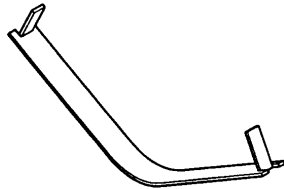

Item # M39608
U/M - Each

Plunger Bolts :

- Snap on white nylon knob
- Aluminum plunger for custom made screening
- 3/16" diameter tip

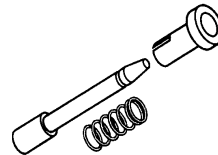

Item # M39833
U/M - Each

Vinyl Lift:

- 1" black vinyl tip

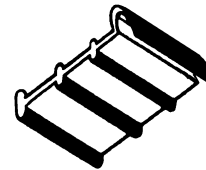

Item # M39604
U/M - Each

5/16" x 3/4" Screen Frame :

- 12' 6" lengths

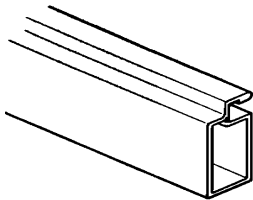

Item #	U/M	Finish
M39565	Each	Mill
M39564	Each	White
M39566	Each	Bronze

Plastic Outside Corner :

- Non-mitered plastic corner for custom made screens
- For 5/16" screen frame

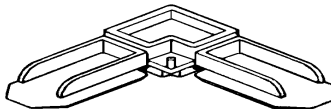

Item #	U/M	Finish
M39587	Each	Gray
M39586	Each	White
M39588	Each	Bronze

Aluminum Corner Angle :

- Mitered corner angles for custom made screens
- Use for 5/16" screen frame

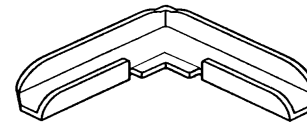

Item # M39847
U/M - Each



MILL SUPPLY CO., INC.

Phone (410) 485-3343
Fax (410) 325-2240

Toll Free 1-800-817-8183

Hardware

BIFOLD/BYPASS DOOR HARDWARE

Metal Bi-Fold Door Pin :

- Bottom pin assembly
- 1/4" diameter pivot pin
- 5-7/8" overall length with 3/8" diameter cap

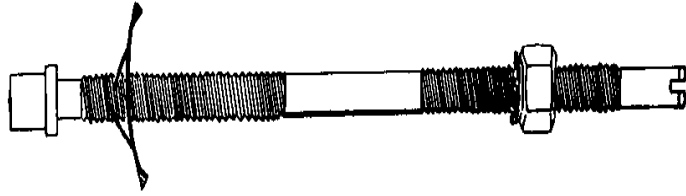

Item # M39782
U/M - Each

Metal Bi-Fold Door Pin :

- Top pivot pin assembly
- 1/4" diameter pivot pin
- 5-7/8" overall length w/ 3/8" diameter cap

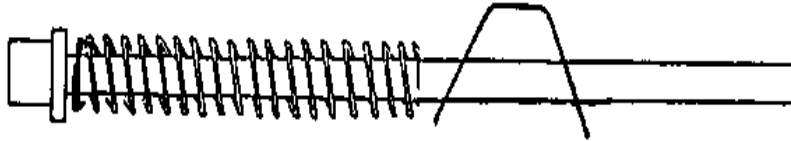

Item # M39734
U/M - Each

Butterfly Aligner :

- For four door installation of wood bifold doors
- Brackets mount on inside of door to keep door closed and aligned
- Zinc plated steel
- Overall size 1-3/4" x 2-3/8"
- Sold by the pair only



Item # M39790
U/M - Pair

Hardware Pack for Bifold Door :

- Set includes: wrench, jamb bracket, bottom pivot, top pivot, snugger, guide wheel, plastic knob, and screws

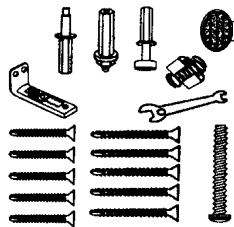

Item # M39792
U/M - Each

Hardware Pack for Bypass Door :

- Includes two pair of slot hangers, floor guide, pair of flush pulls, and screws

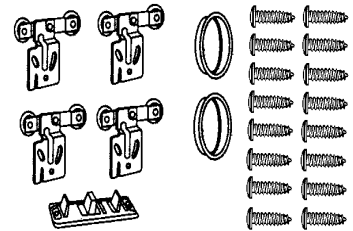

Item # M39796
U/M - Each



MILL SUPPLY CO., INC.

Phone (410) 485-3343
Fax (410) 325-2240

Toll Free 1-800-817-8183

Hardware

BIFOLD/BYPASS DOOR HARDWARE

Bi-Fold Hardware Set w/Track :

- For 7/8" - 1-3/8" doors up to 30 lbs. each
- Set includes: track, top pivot, top guide wheel, bottom pivot, jamb bracket, pair of hinges, and knob (aligners w/48" track and larger)

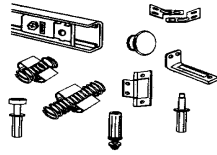

Item #	U/M	Size
M39712	Each	24"
M39714	Each	36"
M39716	Each	48"
M39718	Each	60"
M39720	Each	72"

Sliding Door Hardware Set w/ Aluminum Track :

- For two 3/4" or 1-3/8" doors up to 60 lbs. each
- Includes track, two pairs of hangers, floor guide, and two finger pulls

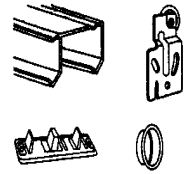

Item #	U/M	Size
M39702	Each	48"
M39704	Each	60"
M39708	Each	72"
M39710	Each	96"

Adjustable Floor Guides :

- Sliding door floor guide
- Adjustable for 3/4", 1", 1-1/3", and 1-3/8" thick by-passing doors



Item # M39731
U/M - Each

Sliding Door Floor Guide :

- 1 piece fixed plastic guide for 1-3/8" by-passing doors

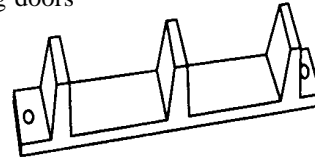

Item # M39742
U/M - Each

Pivot Bracket for Metal Doors :

- 1-3/4" x 3/4"



Item # M39780
U/M - Each

Bifold Track Bracket :

- Pivot bracket only

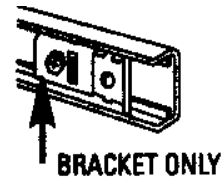

Item # M39724
U/M - Each

Pivot Bracket :

- Pivot bracket
- Bracket is adjustable with wrench or screwdriver after installation

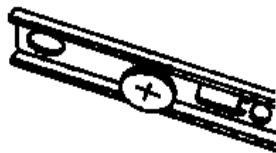

Item # M39730
U/M - Each

Bifold Door Jamb Bracket :

- Plastic pivot socket securely engages pivot and holds horizontal position
- Socket can be horizontally adjusted

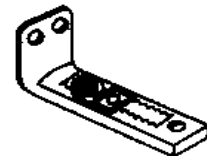

Item # M39736
U/M - Each



MILL SUPPLY CO., INC.

Phone (410) 485-3343
Fax (410) 325-2240

Toll Free 1-800-817-8183

Hardware

BIFOLD/BYPASS DOOR HARDWARE

Bifold Top Guide Wheel :

- 3/8" Hole



Item # M39800
U/M - Each

Bifold Spring Loaded Top Guide Pivot :

- 1/4" Hole

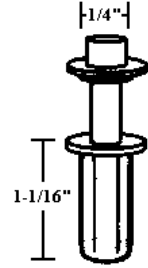

Item # M39739
U/M - Each

Plunger Pins :

- 1/4" Hole

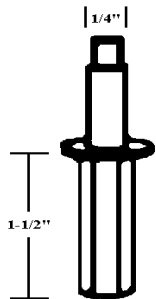

Item # M39726
U/M - Each

Bifold Door Top Pivot :

- 3/8" Hole

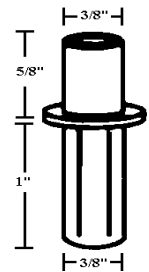

Item # M39728
U/M - Each

Bifold Door Bottom Pivot :

- 7/16" Hole

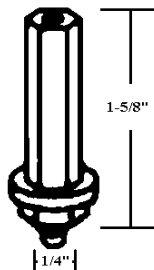

Item # M39798
U/M - Each

Bifold Door Bottom Pivot :

- 7/16" Hole

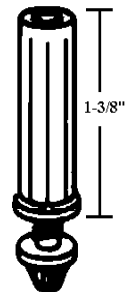

Item # M39738
U/M - Each

Bifold Door Bottom Pivot :

- 3/8" Hole

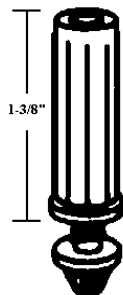

Item # M39740
U/M - Each

Bifold Door Slide Guide :

- Made of durable plastic

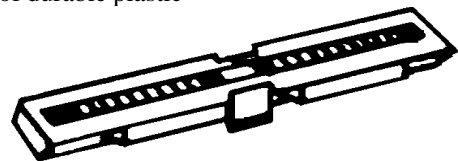

Item # M39802
U/M - Each



MILL SUPPLY CO., INC.

Phone (410) 485-3343
Fax (410) 325-2240

Toll Free 1-800-817-8183

Hardware

Hardware

CLOSET HARDWARE

Free-Slide Shelving :

- Ideal for closets
- Allows continuous movement and convenient selection of hanging garments
- White epoxy coated finish
- Available in 12" and 16" widths

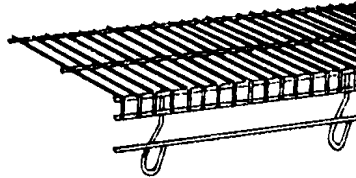

Item #	U/M	Description
M34726	Each	12" Shelving 12' Length
M34727	Each	16" Shelving 12' Length
M34728	Each	12" Corner Shelf
M34729	Each	16" Corner Shelf

Tight Mesh Shelving :

- 1/2" deck wires are stronger, more durable and prevent small items from tipping over and falling through
- Perfect for pantries and garage
- White epoxy coated finish
- Available in 9", 12", 16" and 20" widths

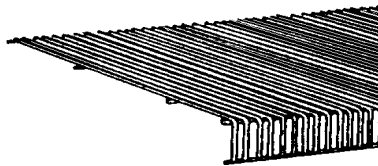

Item #	U/M	Description
M34730	Each	9" Shelving 12' Length
M34731	Each	12" Shelving 12' Length
M34732	Each	16" Shelving 12' Length
M34733	Each	20" Shelving 12' Length

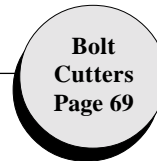

Shelf & Rod Shelving :

- Great for use in hall closets and off season storage closets
- White epoxy coated finish
- Available in 12" and 16" widths

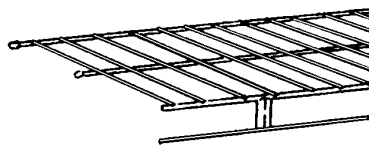

Item #	U/M	Description
M34734	Each	12" Shelving 12' Length
M34735	Each	16" Shelving 12' Length
M34736	Each	12" Corner Shelf
M34737	Each	16" Corner Shelf

Linen Shelving :

- Great for use in hall closets and off season storage closets
- White epoxy coated finish
- Available in 12", 16" and 20" widths

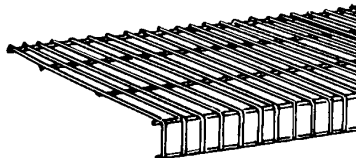

Item #	U/M	Description
M34739	Each	9" Shelving 12' Length
M34740	Each	12" Shelving 12' Length
M34741	Each	16" Shelving 12' Length
M34742	Each	20" Shelving 12' Length



MILL SUPPLY CO., INC.

Phone (410) 485-3343
Fax (410) 325-2240

Toll Free 1-800-817-8183

Hardware

Hardware

CLOSET HARDWARE

1/2" Back Clip:

- With preloaded silver metal pin
- Flap locks shelf into clip
- Made of durable white plastic

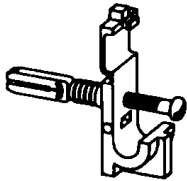

Item # M34756
U/M - Each

Wall Bracket :

- With preloaded metal pin
- Made of durable white plastic



Item # M34758
U/M - Each

Free Slide Wall Bracket :

- With preloaded metal pin
- For use only with free slide shelving
- Made of durable white plastic

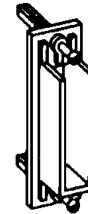

Item # M34759
U/M - Each

Wall Anchor :

- With preloaded metal pin (for support braces)

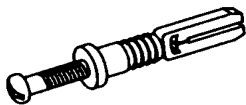

Item # M34757
U/M - Each

Universal Support Braces :

- 9" (Fits all 9" shelving)
- 12" (Fits all 12" shelving, 16" f/s, & 16" shelf & rod)
- 16" (Fits all 16"-20" tight mesh / 16"-20" linen shelving)
- White



Item #	Unit	Size
M34751	Each	9"
M34752	Each	12"
M34753	Each	16"

Caps :

- Used to conceal exposed ends on shelving
- Square caps are for use with support poles
- White

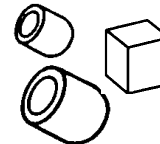

Item #	U/M	Size
M34760	Each	Small
M34761	Each	Large
M34762	Each	Square

Metal Corner Bracket :

- Levels 2 shelves in a 90 degree corner
- White finish

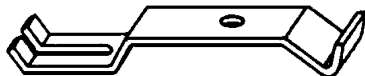

Item # M34772
U/M - Each

Rod Spacer Cap :

- Used to conceal exposed shelf ends
- Made of durable white plastic



Item # M34768
U/M - Each

Free Slide Rod Spacer Cap :

- Used to conceal exposed shelf ends
- For use only with free slide shelving
- Made of durable white plastic

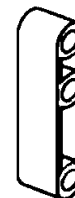

Item # M34769
U/M - Each



MILL SUPPLY CO., INC.

Phone (410) 485-3343
Fax (410) 325-2240

Toll Free 1-800-817-8183

Hardware

CLOSET HARDWARE

Joiner Plate Set :

- Used to join two pieces of shelving
- Two piece
- Made of durable white plastic

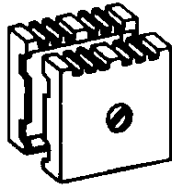

Item # M34755
U/M - Each

All Purpose Clamp :

- Used to support shelf to wall
- Made of durable white plastic
- Screws not included



Item # M34763
U/M - Each

Shoe Shelf Support :

- Can be used on linen and tight mesh shelves
- Snaps into place
- Made of durable white plastic

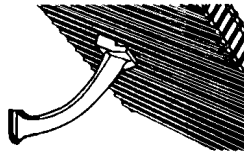

Item # M34773
U/M - Each

Shelf Edge Trim :

- 8' sections
- Covers unfinished shelf ends when shelves are cut at an angle
- White finish

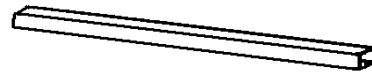

Item # M34770
U/M - Each

84" Pole :

- 1/2" square
- Fits all shelf types
- White finish

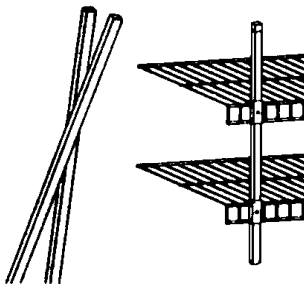

Item # M34764
U/M - Each

Pole Clamp :

- Fits all shelf types except Tight Mesh
- Made of durable white plastic

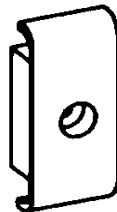

Item # M34767
U/M - Each

Tight Mesh Pole Clamp :

- Fits all shelf types
- Used when pole is on outside of shelf
- Made of durable white plastic

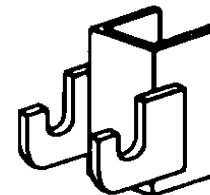

Item # M34766
U/M - Each



MILL SUPPLY CO., INC.

Phone (410) 485-3343
Fax (410) 325-2240

Toll Free 1-800-817-8183

Hardware

CLOSET HARDWARE

Shelf Bracket :

- Grey finish
- Metal

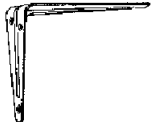

Item #	U/M	Size
M18649	Each	6" x 8"
M18653	Each	8" x 10"
M18655	Each	10" x 12"

Combination Closet Shelf & Rod Support :

- White finish
- With screws
- Metal

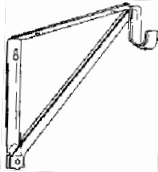

Item # M76609
U/M - Each

Adj. Closet Rod :

- Chrome finish
- 1" Round tube
- Includes all mounting hardware

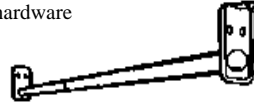

Item #	U/M	Size
M76621	Each	18"- 30"
M76625	Each	30"-48"
M76628	Each	48"-72"
M76630	Each	72"-96"
M76636	Each	72"-120"
M76633	Each	96"-150"

Plastic Pole Sockets :

- Fits poles 1-3/8" or smaller
- Sold by the pair

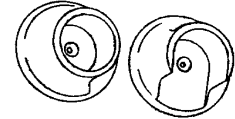

Item # M76603
U/M - Pair

White Plastic Knob :

- 1-1/2" Diameter
- Screw included

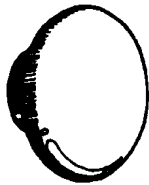

Item # M35546
U/M - Each

Brass Ball Knob :

- 1-1/4" Diameter
- Screw included
- Brass plated



Item # M35537
U/M - Each

Ceramic Ball Knobs :

- 1-1/4" Diameter
- Screw included

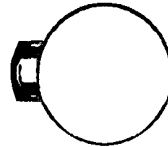

Item #	U/M	Color
M35539	Each	White
M35532	Each	Almond

Ceramic Mushroom Knobs :

- 1-1/2" Diameter
- Screw included



Item #	U/M	Color
M35549	Each	White
M35542	Each	Almond

Cabinet Knobs :

- Screw included

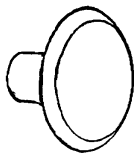

Item #	U/M	Size/Finish
M35518	Each	1-1/2" Brass
M35521	Each	1-1/2" Chrome
M35529	Each	1-7/8" Brass
M35530	Each	1-7/8" Chrome
M35515	Each	1-1/2" Ant. Brass

Cabinet Knob :

- Antique brass
- Screw included



Item # M35509
U/M - Each

Knob Backplates :

- 2-1/2" diameter

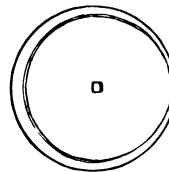

Item #	U/M	Finish
M35516	Each	Ant. Brass
M35526	Each	Brass
M35523	Each	Chrome

Closet Door Pull :

- Polished brass
- Fits 2-1/8" diameter hole
- Recessed mount

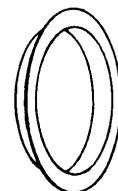

Item # M34997
U/M - Each



MILL SUPPLY CO., INC.

Phone (410) 485-3343
Fax (410) 325-2240

Toll Free 1-800-817-8183

Hardware

Hardware

CABINET HARDWARE/TUB SHOWER HARDWARE

Cabinet Hinge :

- 3/8" Inset design
- Self closing
- Antique brass

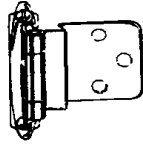

Item # M35501
U/M - Each

Cabinet Hinge :

- Flush type
- Self closing
- Antique brass

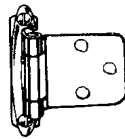

Item # M38414
U/M - Each

Cabinet Pull :

- 5" Length
- 3" Hole spacing
- Polished brass with white insert



Item # M35510
U/M - Each

Cabinet Catch :

- Zinc plated steel housing
- Heavy duty spring tension roller catch
- Nylon wheel
- Elongated screw hole for easy adjustment

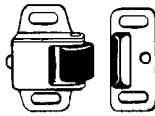

Item # M34852
U/M - Each

Cabinet Catch :

- Double roller
- Twin roller wheels for silent closing
- Elongated screw holes for easy adjustment

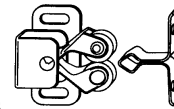

Item # M34855
U/M - Each

Rear Guide :

- For 1-1/8" wood rails
- 2-1/2" wide plate
- White

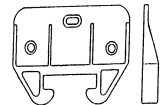

Item # M35454
U/M - Each

Rear Guide :

- For 3/4" wood rails
- 2" wide plate
- White

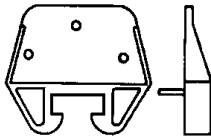

Item # M35460
U/M - Each

Front Roller :

- 15/16" Diameter roller
- Right hand



Item # M35430
U/M - Each

Front Roller :

- 15/16" Diameter roller
- Left hand



Item # M35436
U/M - Each

Shelf Clip :

- Made of durable plastic
- 1/4" diameter pin

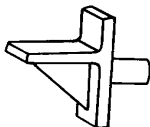

Item # M35308
U/M - Each

Shelf Clip :

- Made of durable plastic
- 1/4" diameter pin
- Lock in type

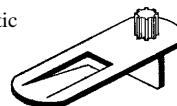

Item # M35316
U/M - Each

Roller Clip :

- 13/16" Nylon roller
- Right hand

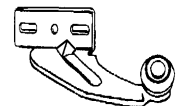

Item # M35424
U/M - Each

Complete Cabinet Drawer Hardware Kit :

- Galvanized
- Includes 2 rollers, track, track mounting bracket and roller bracket
- Sold as a complete set only

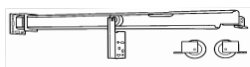

Item # M35484
U/M - Each

Magnetic Catch :

- Designed for entire range of cabinet door applications
- Floating magnetic assembly provides self-alignment
- Plastic casing with adjustable screw slot
- Self-locating strike
- Furnished with screws

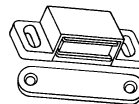

Item # M34867
U/M - Each

Shower Door Roller :

- Flat nylon replacement
- For sliding tub and shower doors
- 3/4" diameter
- Ball bearing axle with machine screws
- Fits most sliding doors
- Furnished with screws



Item # M39810
U/M - Each



MILL SUPPLY CO., INC.

Phone (410) 485-3343
Fax (410) 325-2240

Toll Free 1-800-817-8183

Hardware

SHOWER DOORS

Tub Enclosure :

- 2 Bypassing doors
- Fits 57-1/2" to 59" openings
- Available in chrome or gold finish with clear or obscure glass
- 57-3/4" height

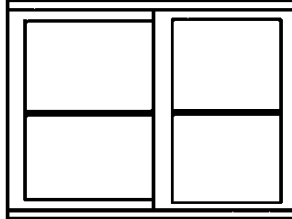

Item #	U/M	Glass	Finish
M35903	Each	Clear	Chrome
M35904	Each	Obscure	Chrome
M35905	Each	Clear	Gold
M35906	Each	Obscure	Gold

Shower Enclosure :

- 2 Bypassing doors
- Available in chrome or gold finish with clear or obscure glass
- 69-3/4" Height

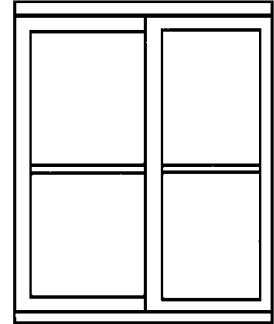

Item #	U/M	Size F/O	Finish	Glass
M35915	Each	45-1/2 - 47"	Chrome	Clear
M35916	Each	45-1/2 - 47"	Chrome	Obscure
M35917	Each	45-1/2 - 47"	Gold	Clear
M35918	Each	45-1/2 - 47"	Gold	Obscure
M35926	Each	57-1/2" - 59"	Chrome	Clear
M35927	Each	57-1/2" - 59"	Chrome	Obscure
M35928	Each	57-1/2" - 59"	Gold	Clear
M35929	Each	57-1/2" - 59"	Gold	Obscure

Silicone
Page 152

Did you know ?

- Installation of shower doors is available
- Any custom shower door can be manufactured to your specifications
- Many other sizes and styles are available

Contact you sales representative for more information.

Levels
Page 80

Shower Door :

- Continuous piano hinge
- 1" Adjustment
- Door is reversible for left or right opening
- Chrome obscure finish
- 68-1/8" height

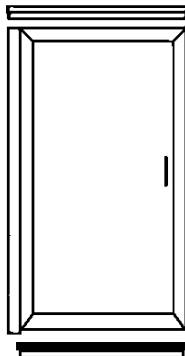

Item #	U/M	Size R/O
M35932	Each	30-1/4" - 31-1/4"
M35936	Each	31-1/4" - 32-1/4"

Shower Door w/Stationary Panel :

- Continuous piano hinge
- 1" Adjustment
- Available in chrome or gold finish with clear or obscure glass
- Door is reversible for left or right opening
- 69-3/4" height

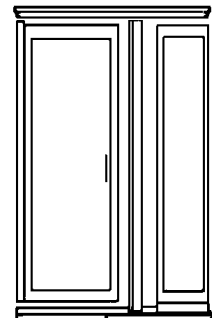

Item #	U/M	Size R/O	Finish	Glass
M35942	Each	34" - 35"	Chrome	Clear
M35943	Each	34" - 35"	Chrome	Obscure
M35944	Each	34" - 35"	Gold	Clear
M35945	Each	34" - 35"	Gold	Obscure
M35951	Each	40" - 41"	Chrome	Clear
M35952	Each	40" - 41"	Chrome	Obscure
M35953	Each	40" - 41"	Gold	Clear
M35954	Each	40" - 41"	Gold	Obscure
M35961	Each	46" - 47"	Chrome	Clear
M35962	Each	46" - 47"	Chrome	Obscure
M35963	Each	46" - 47"	Gold	Clear
M35964	Each	46" - 47"	Gold	Obscure



MILL SUPPLY CO., INC.

Phone (410) 485-3343
Fax (410) 325-2240

Toll Free 1-800-817-8183

Hardware

SHOWER DOORS

Shower Enclosure :

- For use in fiberglass modular showers
- 2 Bypassing doors
- Chrome finish obscure glass
- 65-3/4" Height

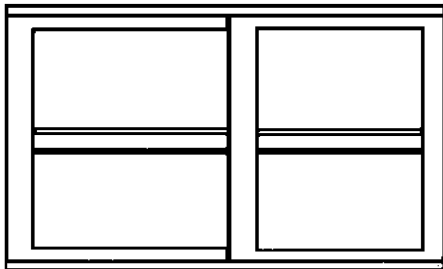

Item #	U/M	Size	R/O
M35970	Each	43-1/2	- 45"

Neo Angle Shower Enclosure :

- 135 Degree Compound Angle
- 18-1/2" x 24" x 18-1/2" Finished Size L/C/R
- Available in chrome or gold finish with clear or obscure glass
- Door is reversible for left or right opening
- Height is 69-3/4"

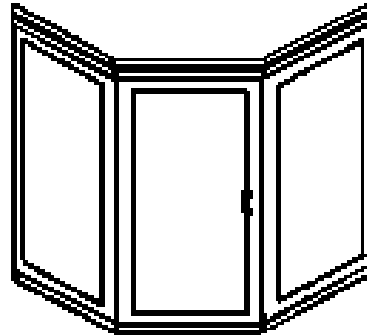

Item #	U/M	Finish	Glass
M35978	Each	Chrome	Clear
M35979	Each	Chrome	Obscure
M35980	Each	Gold	Clear
M35981	Each	Gold	Obscure

Shower Door Accessories

Hardware Kit For Tub / Shower Enclosures :

- Includes : 4/ea clear door bumpers, 4/ea white door rollers, 4/ea towel bar brackets, 4/ea caps for door bottom, 12/ea 8-32 x 1/2" php machine screws for rollers or brackets, 4/ea wall anchors, 4/ea wall anchor screws
- Fits our doors #'s : M35903, M35904, M35905, M35906, M35915, M35916, M35917, M35918, M35926, M35927, M35928 and M35929



Item #	U/M	Finish
M35991	Each	Chrome
M35992	Each	Gold

Towel Bar For Tub / Shower Enclosures :

- 25-1/4" length
- Does not include brackets
- Fits our doors #'s : M35903, M35904, M35905, M35906, M35915, M35916, M35917, M35918, M35926, M35927, M35928 and M35929

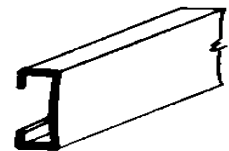

Item #	U/M	Finish
M35993	Each	Chrome
M35994	Each	Gold

Top Track For Tub / Shower Enclosures :

- 61" length
- Fits our doors #'s : M35903, M35904, M35905, M35906, M35915, M35916, M35917, M35918, M35926, M35927, M35928 and M35929

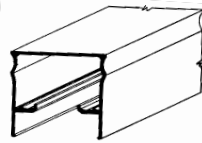

Item #	U/M	Finish
M35995	Each	Chrome
M35996	Each	Gold

Bottom Track For Tub / Shower Enclosures :

- 61" length
- Fits our doors #'s : M35903, M35904, M35905, M35906, M35915, M35916, M35917, M35918, M35926, M35927, M35928 and M35929

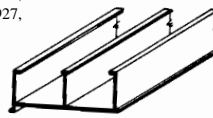

Item #	U/M	Finish
M35997	Each	Chrome
M35998	Each	Gold

Wall Jamb For Tub / Shower Enclosures :

- 56-1/4" length
- Fits our doors #'s : M35903, M35904, M35905, M35906, M35915, M35916, M35917, M35918, M35926, M35927, M35928 and M35929

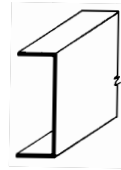

Item #	U/M	Finish
M35999	Each	Chrome
M36000	Each	Gold



MILL SUPPLY CO., INC.

Phone (410) 485-3343
Fax (410) 325-2240

Toll Free 1-800-817-8183

Hardware

Hardware

ECONOMY LOCKSETS

Entry Lockset :

- Adjustable backset, 2-3/8" or 2-3/4"
- Cylinder removable for rekeying and reversible for right/left hand opening
- KW1 keyway
- 5 Pin tumbler solid brass cylinder
- Tubular construction
- Oversize positive turn-button interior locking
- Fits wood or metal doors from 1-3/8" to 1-3/4" thick
- Standard 2-1/8" installation hole
- Value priced

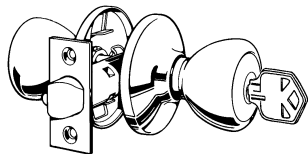

Item #	U/M	Finish
M33080	Each	Ant. Brass
M33081	Each	Polished Brass
M33069	Each	Dull Chrome

Privacy Lockset :

- 2-3/8" Radius corner backset
- Tubular construction
- Oversize positive turn button
- Interior locking
- Fits wood or metal doors from 1-3/8" - 1-3/4" thick
- Standard 2-1/8" installation
- Value priced

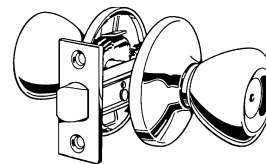

Item #	U/M	Finish
M33085	Each	Ant. Brass
M33087	Each	Polished Brass
M33091	Each	Dull Chrome
M33092	Each	Brass x Chrome

Passage Lockset :

- 2-3/8" Radius corner backset
- Tubular construction
- Fits wood or metal doors from 1-3/8" - 1-3/4" thick
- Standard 2-1/8" installation hole
- Value priced

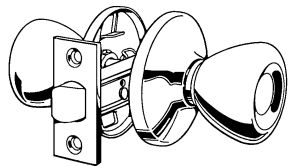

Item #	U/M	Finish
M33097	Each	Ant. Brass
M33099	Each	Polished Brass
M33102	Each	Dull Chrome

Lever Sets :

- Reversible, non-handed
- Tubular construction
- Standard 2-1/8" installation hole
- Elegant scroll design lever handles
- Interior locking with positive turn button (passage)
- Fits wood and metal doors from 1-3/8" to 1-3/4" thick
- Radius corner strikes and latches
- Adjustable backset, 2-3/8" or 2-3/4"
- Value priced

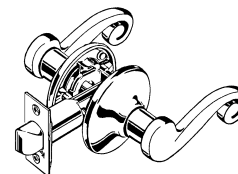

Item #	U/M	Type
M33030	Each	Dummy
M33032	Each	Privacy
M33034	Each	Passage



MILL SUPPLY CO., INC.

Phone (410) 485-3343
Fax (410) 325-2240

Toll Free 1-800-817-8183

Hardware

ECONOMY LOCKSETS

Single Cylinder Deadbolt :

- Meets all ANSI grade 3 specifications
- 5 Pin tumbler cylinder
- KW1 keyway
- Adjustable backset 2-3/8" or 2-3/4"
- Reversible for left or right hand
- Full 1" throw
- Fits wood or metal doors from 1-3/8" - 1-3/4" thick
- Removable and re-keyable solid brass cylinder
- Solid brass construction
- Heavy gauge strike plates and hardened steel core bar

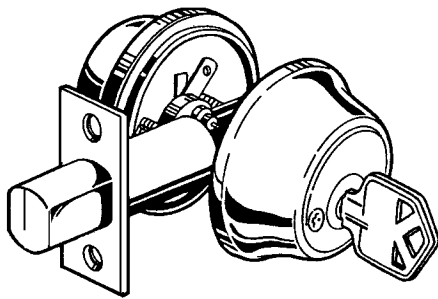

Item #	U/M	Finish
M33075	Each	Stainless
M33077	Each	Pol. Brass
M33078	Each	Ant. Brass

Double Cylinder Deadbolt :

- Meets all ANSI grade 3 specifications
- 5 Pin tumbler cylinder
- KW1 keyway
- Adjustable backset 2-3/8" or 2-3/4"
- Reversible for left or right hand
- Full 1" throw
- Fits wood or metal doors from 1-3/8" - 1-3/4" thick
- Removable and re-keyable solid brass cylinder
- Solid brass construction
- Heavy gauge strike plates and hardened steel core bar
- Excellent for doors with glass inserts.

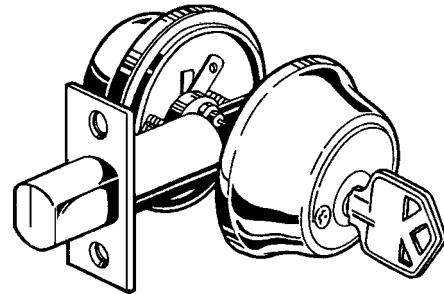

Item #	U/M	Finish
M33076	Each	Stainless
M33079	Each	Pol. Brass
M33080	Each	Ant. Brass

Interior Plastic Locks :

- These locksets are set apart from convention because it cannot rust, tarnish or corrode - even in salt air climates. The smooth-turning, "no rattle" knob is always warm to the touch - and shock-proof too, since it doesn't conduct static electricity. And it needs no lubrication, ever. Speed of installation is remarkable, too, using only a single pre-installed (and concealed) screw to tighten.
- Fewer working parts means longer life. In independent laboratory testing, they have successfully completed one million cycles of operation. These locksets meet the performance requirements of ANSI 156.2, Series 4000, Grade 3 locks.
- Fits all interior doors 1" to 1-1/2" in thickness (1-1/8" min. door thickness when used with round face drive-in latch. For doors over 1-1/2" in thickness, consult your sales representative.

Functions:	Passage, privacy (with push-pull locking mechanism for bath rooms, bedrooms, and dummy knobs. Privacy model has emergency release operated from the outside)
Backset:	2-3/8" Radius corner
Side Bore:	2-1/8"
Latch Bolt:	Full 1/2" throw
Knob/Rosette:	2" diameter/ 2-3/4" diameter

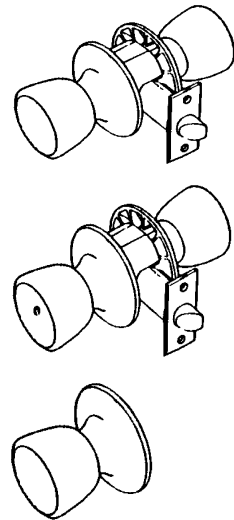

Item #	U/M	Type
M30011	Each	Passage
M30015	Each	Privacy
M30019	Each	Dummy



MILL SUPPLY CO., INC.

Phone (410) 485-3343
Fax (410) 325-2240

Toll Free 1-800-817-8183

Hardware

KWIKSET

Kwikset
CORPORATION

Tylo Design Locksets :

- Form follows function in the economical Tylo design, ideal for new construction or as a replacement lockset

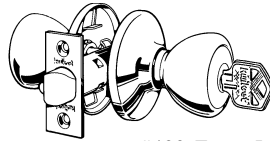

#400 Entry Lock

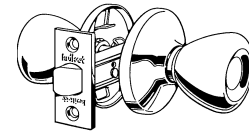

#200 Passage Lock

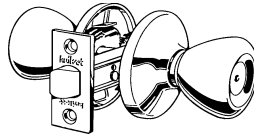

#300 Privacy Lock



#488 Dummy knob

Item #	U/M	Description	Finish	Backset / Latch	Strike
M31002	Each	Entry Lock	Polished Brass	6 Way Adjustable	2-1/4" - Radius Corner
M31003	Each	Entry Lock	Antique Brass	6 Way Adjustable	2-1/4" - Radius Corner
M31004	Each	Entry Lock	Satin Chrome	6 Way Adjustable	2-1/4" - Radius Corner
M31008	Each	Privacy Lock	Polished Brass	2-3/8" - Radius Corner	2-1/4" - Radius Corner
M31009	Each	Privacy Lock	Antique Brass	2-3/8" - Radius Corner	2-1/4" - Radius Corner
M31010	Each	Privacy Lock	Satin Chrome	2-3/8" - Radius Corner	2-1/4" - Radius Corner
M31013	Each	Bathroom Lock	Pol. Brass x Pol. Chrome	2-3/8" - Radius Corner	2-1/4" - Radius Corner
M31017	Each	Passage Lock	Polished Brass	2-3/8" - Radius Corner	2-1/4" - Radius Corner
M31018	Each	Passage Lock	Antique Brass	2-3/8" - Radius Corner	2-1/4" - Radius Corner
M31019	Each	Passage Lock	Satin Chrome	2-3/8" - Radius Corner	2-1/4" - Radius Corner
M31022	Each	Dummy Knob	Polished Brass	N/A	N/A
M31023	Each	Dummy Knob	Antique Brass	N/A	N/A
M31024	Each	Dummy Knob	Satin Chrome	N/A	N/A

Polo Design Locksets :

- Low in price but classic in design. The Polo by kwikset has become one of America's favorite locksets, whether used for new construction or as a replacement lockset

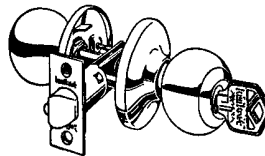

#400 Entry Lock

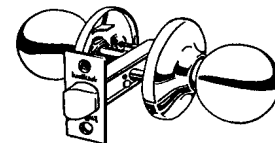

#200 Passage Lock

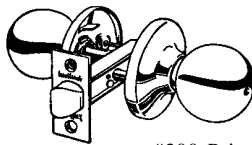

#300 Privacy Lock

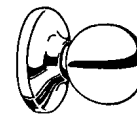

#488 Dummy knob

Kwikset
CORPORATION

Item #	U/M	Description	Finish	Backset / Latch	Strike
M31051	Each	Entry Lock	Polished Brass	6 Way Adjustable	2-1/4" - Radius Corner
M31057	Each	Privacy Lock	Polished Brass	2-3/8" - Radius Corner	2-1/4" - Radius Corner
M31058	Each	Privacy Lock	Polished Chrome	2-3/8" - Radius Corner	2-1/4" - Radius Corner
M31063	Each	Bathroom Lock	Pol. Brass x Pol. Chrome	2-3/8" - Radius Corner	2-1/4" - Radius Corner
M31068	Each	Passage Lock	Polished Brass	2-3/8" - Radius Corner	2-1/4" - Radius Corner
M31069	Each	Passage Lock	Polished Chrome	2-3/8" - Radius Corner	2-1/4" - Radius Corner
M31075	Each	Dummy Knob	Polished Brass	N/A	N/A
M31076	Each	Dummy Knob	Polished Chrome	N/A	N/A



MILL SUPPLY CO., INC.

Phone (410) 485-3343
Fax (410) 325-2240

Toll Free 1-800-817-8183

Hardware

Hardware

KWIKSET

Kwikset
CORPORATION

Belair Design Locksets :

- The most versatile and popular knob design of the century. The delicate tulip shape blends ideally with any style of interior or exterior door.

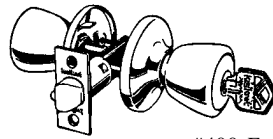

#400 Entry Lock

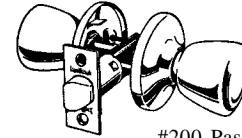

#200 Passage Lock

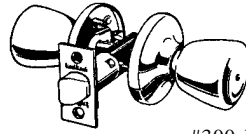

#300 Privacy Lock

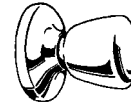

#488 Dummy knob

Item #	U/M	Description	Finish	Backset / Latch	Strike
M31101	Each	Entry Lock	Polished Brass	6 Way Adjustable	2-1/4" - Radius Corner
M31102	Each	Entry Lock	Antique Brass	6 Way Adjustable	2-1/4" - Radius Corner
M31103	Each	Entry Lock	Satin Chrome	6 Way Adjustable	2-1/4" - Radius Corner
M31107	Each	Vestibule Lock	Polished Brass	2-3/8" - Radius Corner	2-1/4" - Radius Corner
M31108	Each	Vestibule Lock	Antique Brass	2-3/8" - Radius Corner	2-1/4" - Radius Corner
M31109	Each	Vestibule Lock	Satin Chrome	2-3/8" - Radius Corner	2-1/4" - Radius Corner
M31114	Each	Privacy Lock	Polished Brass	2-3/8" - Radius Corner	2-1/4" - Radius Corner
M31116	Each	Privacy Lock	Satin Chrome	2-3/8" - Radius Corner	2-1/4" - Radius Corner
M31119	Each	Bathroom Lock	Pol. Brass x Pol. Chrome	2-3/8" - Radius Corner	2-1/4" - Radius Corner
M31123	Each	Passage Lock	Polished Brass	2-3/8" - Radius Corner	2-1/4" - Radius Corner
M31125	Each	Passage Lock	Satin Chrome	2-3/8" - Radius Corner	2-1/4" - Radius Corner
M31132	Each	Dummy Knob	Polished Brass	N/A	N/A
M31134	Each	Dummy Knob	Satin Chrome	N/A	N/A

Valiant Design Locksets :

Kwikset
CORPORATION

- The standard design.....one of the oldest knob shapes in existence, is as pleasing today as it was 50 years ago. Especially recommended for use with colonial styled architecture.

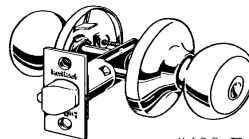

#400 Entry Lock

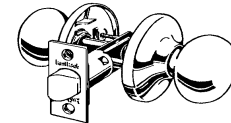

#200 Passage Lock

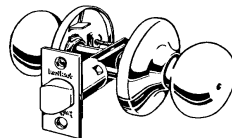

#300 Privacy Lock



#488 Dummy knob

Item #	U/M	Description	Finish	Backset / Latch	Strike
M31152	Each	Entry Lock	Polished Brass	6 Way Adjustable	2-1/4" - Radius Corner
M31158	Each	Privacy Lock	Polished Brass	2-3/8" - Radius Corner	2-1/4" - Radius Corner
M31164	Each	Bathroom Lock	Pol. Brass x Pol. Chrome	2-3/8" - Radius Corner	2-1/4" - Radius Corner
M31167	Each	Passage Lock	Polished Brass	2-3/8" - Radius Corner	2-1/4" - Radius Corner
M31170	Each	Dummy Knob	Polished Brass	N/A	N/A



MILL SUPPLY CO., INC.

Phone (410) 485-3343
Fax (410) 325-2240

Toll Free 1-800-817-8183

Hardware

Copa Design Locksets :

- Any home or apartment, from colonial to contemporary, can benefit from the handsomely styled design

KWIKSET

Kwikset.
CORPORATION

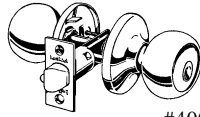

#400 Entry Lock

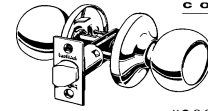

#200 Passage Lock

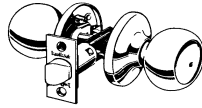

#300 Privacy Lock



#488 Dummy knob

Item #	U/M	Description	Finish	Backset / Latch	Strike
M31202	Each	Entry Lock	Antique Brass	6 Way Adjustable	2-1/4" - Radius Corner
M31214	Each	Privacy Lock	Antique Brass	2-3/8" - Radius Corner	2-1/4" - Radius Corner
M31229	Each	Passage Lock	Antique Brass	2-3/8" - Radius Corner	2-1/4" - Radius Corner
M31236	Each	Dummy Knob	Antique Brass	N/A	N/A

Eclipse Design Locksets :

- A distinctive knob design to enhance any architectural style, will add a touch of luxury to every door

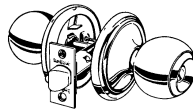

#400 Entry Lock



#200 Passage Lock

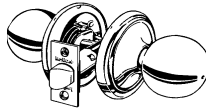

#300 Privacy Lock

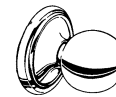

#488 Dummy knob

Item #	U/M	Description	Finish	Backset / Latch	Strike
M31253	Each	Entry Lock	Polished Brass	6 Way Adjustable	2-1/4" - Radius Corner
M31259	Each	Privacy Lock	Polished Brass	2-3/8" - Radius Corner	2-1/4" - Radius Corner
M31264	Each	Bathroom Lock	Pol. Brass x Pol. Chrome	2-3/8" - Radius Corner	2-1/4" - Radius Corner
M31268	Each	Passage Lock	Polished Brass	2-3/8" - Radius Corner	2-1/4" - Radius Corner
M31274	Each	Dummy Knob	Polished Brass	N/A	N/A

Locksets - Specifications & Technical Information

	Tylo / Polo / Valiant	Belair / Copa / Eclipse
Door Prep	Crossbore 2-1/8" Edge Bore 1" Latch Face 1" x 2-1/4"	Crossbore 2-1/8" Edge Bore 1" Latch Face 1" x 2-1/4"
Backset	Lock Specific	Lock Specific
Door Thickness	1-3/8" - 1-3/4" Doors Standard	1-3/8" - 1-3/4" Doors Standard
Cylinder	5-Pin	5-Pin
Faceplates	Lock Specific	Lock Specific
Strikes	2-1/4" Full Lip Radius Corner Standard	2-1/4" Full Lip Radius Corner Standard
Bolt	1/2" Throw (Passage/Privacy/Bathroom 3/8" Throw*)	1/2" Throw
Door Handing	Reversible For Right or Left Hand Doors	Reversible For Right or Left Hand Doors
ANSI/BHMA	A156.2 Grade 3	A156.2 Grade 3

* Tylo & Polo only

Knob Dimensions

Design	A	B	C
Tylo	2-5/8"	2-3/8"	1-7/8"
Polo	2-5/8"	2-3/4"	1-7/8"
Belair	2-5/8"	2-3/8"	1-7/8"
Valiant	2-5/8"	2-1/4"	1-7/8"
Copa	2-5/8"	2-3/8"	2-1/8"
Eclipse	2-5/8"	3"	2-1/8"

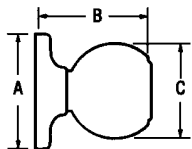

Model	Type / Function
200	Passage/Hall/Closet: Both knobs always free.
300	Privacy/Bed/Bath: Both knobs locked or unlocked by turnbutton inside. Outside knob unlocked by emergency key.
300	Privacy/Bathroom: Same function as 300 above. Inside knob is polished chrome.
400	Entry: Both knobs locked, or unlocked by key outside or turnbutton inside.
450	Storeroom/Vestibule: Outside unlocked only while key is turned. Inside always free.
488	Half Dummy Trim, Surface Mounted: For doors where only a pull is required. No operation.



MILL SUPPLY CO., INC.

Phone (410) 485-3343
Fax (410) 325-2240

Toll Free 1-800-817-8183

Hardware

KWIKSET

Delta Lever Lockset :

- Simplicity is the key to the beauty of the Delta leversets. The design is beautifully functional. It combines a clean contemporary look with Kwikset's high quality craftsmanship.
- Delta levers are reversible for right or left handed applications.

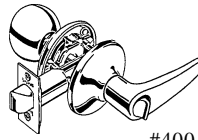

#400 Entry Lock

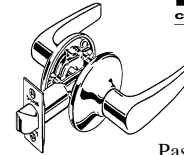

Passage Lock

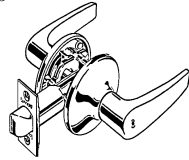

Privacy Lock

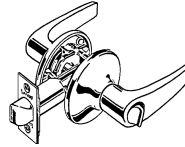

#405 Entry Lock



Dummy Knob

Item #	U/M	Description	Finish	Backset / Latch	Strike
M31301	Each	Entry Lock # 400	Polished Brass	Adjustable - Square Corner	2-1/4" - Radius Corner
M31304	Each	Entry Lock # 405	Polished Brass	Adjustable - Square Corner	2-1/4" - Radius Corner
M31306	Each	Entry Lock # 405	Satin Chrome	Adjustable - Square Corner	2-1/4" - Radius Corner
M31307	Each	Vestibule Lock	Satin Chrome	Adjustable - Square Corner	2-1/4" - Radius Corner
M31322	Each	Privacy Lock	Polished Brass	2-3/8" - Radius Corner	2-1/4" - Radius Corner
M31324	Each	Privacy Lock	Polished Chrome	2-3/8" - Radius Corner	2-1/4" - Radius Corner
M31327	Each	Bathroom Lock	Pol. Brass x Pol. Chrome	2-3/8" - Radius Corner	2-1/4" - Radius Corner
M31329	Each	Passage Lock	Polished Brass	2-3/8" - Radius Corner	2-1/4" - Radius Corner
M31353	Each	Passage Lock	Polished Chrome	2-3/8" - Radius Corner	2-1/4" - Radius Corner
M31356	Each	Dummy Knob	Polished Brass	N/A	N/A
M31357	Each	Dummy Knob	Polished Chrome	N/A	N/A

*Split finishes are listed with Outside lever finish 1st, then inside finish 2nd.

Lido Lever Locksets :

- A stylish scroll-shaped lever that adds beauty and richness to every door throughout the home. Extremely dramatic when used side by side on double doors.
- Lido levers must be ordered right or left handed.

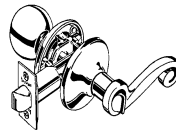

#400 Entry Lock

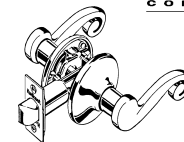

Passage Lock

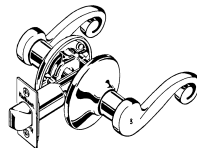

Privacy Lock

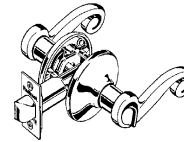

#405 Entry Lock



Dummy knob

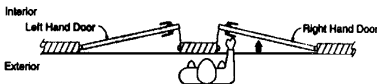

Item #	U/M	Description / Hand	Finish*	Backset / Latch	Strike
M31362	Each	Entry Lock # 400 - Left Hand	Polished Brass	Adjustable - Square Corner	2-1/4" - Radius Corner
M31363	Each	Entry Lock # 400 - Right Hand	Polished Brass	Adjustable - Square Corner	2-1/4" - Radius Corner
M31367	Each	Entry Lock # 405 - Left Hand	Polished Brass	Adjustable - Square Corner	2-1/4" - Radius Corner
M31368	Each	Entry Lock # 405 - Right Hand	Polished Brass	Adjustable - Square Corner	2-1/4" - Radius Corner
M31374	Each	Privacy Lock - Left Hand	Polished Brass	2-3/8" - Radius Corner	2-1/4" - Radius Corner
M31375	Each	Privacy Lock - Right Hand	Polished Brass	2-3/8" - Radius Corner	2-1/4" - Radius Corner
M31381	Each	Bathroom Lock - Left Hand	Pol. Brass x Pol. Chrome	2-3/8" - Radius Corner	2-1/4" - Radius Corner
M31382	Each	Bathroom Lock - Right Hand	Pol. Brass x Pol. Chrome	2-3/8" - Radius Corner	2-1/4" - Radius Corner
M31385	Each	Passage Lock - Left Hand	Polished Brass	2-3/8" - Radius Corner	2-1/4" - Radius Corner
M31386	Each	Passage Lock - Right Hand	Polished Brass	2-3/8" - Radius Corner	2-1/4" - Radius Corner
M31397	Each	Dummy Knob - Right Hand	Polished Brass	N/A	N/A
M31398	Each	Dummy Knob - Left Hand	Polished Brass	N/A	N/A

*Split finishes are listed with Outside lever finish 1st, then inside finish 2nd.



MILL SUPPLY CO., INC.

Phone (410) 485-3343
Fax (410) 325-2240

Toll Free 1-800-817-8183

Hardware

KWIKSET

Saxton Lever Locksets :



- The Saxton brings a new elegance to every door throughout your home. The graceful curve of the lever bends beautifully into a variety of architectural styles and decors, ranging from traditional to contemporary

- Saxton levers must be ordered right or left handed

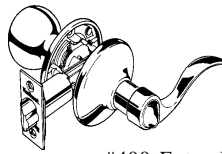

#400 Entry Lock

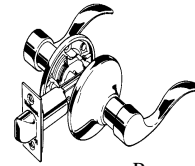

Passage Lock

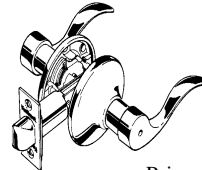

Privacy Lock



Dummy Knob

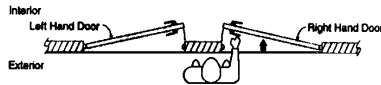

Item #	U/M	Description / Hand	Finish*	Backset / Latch	Strike
M31401	Each	Entry Lock # 400 - Left Hand	Polished Brass	Adjustable - Square Corner	2-1/4" - Radius Corner
M31402	Each	Entry Lock # 400 - Right Hand	Polished Brass	Adjustable - Square Corner	2-1/4" - Radius Corner
M31416	Each	Privacy Lock - Left Hand	Polished Brass	2-3/8" - Radius Corner	2-1/4" - Radius Corner
M31417	Each	Privacy Lock - Right Hand	Polished Brass	2-3/8" - Radius Corner	2-1/4" - Radius Corner
M31425	Each	Passage Lock - Left Hand	Polished Brass	2-3/8" - Radius Corner	2-1/4" - Radius Corner
M31426	Each	Passage Lock - Right Hand	Polished Brass	2-3/8" - Radius Corner	2-1/4" - Radius Corner
M31432	Each	Dummy Knob - Right Hand	Polished Brass	N/A	N/A
M31433	Each	Dummy Knob - Left Hand	Polished Brass	N/A	N/A

Leversets - Specifications & Technical Information

Lever Dimensions

	Design	A	B	C	KEL
	Delta	2-5/8"	3-5/8"	1-7/8"	2-5/8"
	Lido	2-5/8"	3-3/4"	15-7/8"	2-5/8"
	Saxton	2-5/8"	3-3/4"	2"	2-5/8"

Finishes

US3	Polished Brass
US5	Antique Brass
US26	Polished Chrome
US26D	Satin Chrome

	Delta / Lido / Saxton
Door Prep	Crossbore 2-1/8" Edge Bore 1" Latch Face 1" x 2-1/4"
Backset	Lock Specific
Door Thickness	1-3/8" - 1-3/4" Doors Standard
Cylinder	5-Pin
Faceplates	Lock specific
Strikes	2-1/4" Full lip radius, Corner standard
Bolt	1" Throw
Door Handing	Lock Specific
ANSI/BHMA	A156.5 Grade 3

	Model	Type / Function
	200	Passage/Hall/Closet: Both knobs always free.
	300	Privacy/Bed/Bath: Both knobs locked or unlocked by turnbutton inside. Outside knob unlocked by emergency key.
	300	Privacy/Bathroom: Same function as 300 above. Inside knob is polished chrome.
	400	Entry: Both knobs locked, or unlocked by key outside or turnbutton inside.
	405	Keyed Entry Lever: Both sides locked or unlocked by key outside or turnbutton inside.
	488	Half Dummy Trim, Surface Mounted: For doors where only a pull is required. No operation.
	462	Vestibule: Outside unlocked only while key is turned. Inside always free.



MILL SUPPLY CO., INC.

Phone (410) 485-3343
Fax (410) 325-2240

Toll Free 1-800-817-8183

Hardware

Hardware

KWIKSET DEADBOLTS

Single Cylinder Deadbolt :

- A standard quality crafted 1" deadbolt offers extra protection at an economical price
- Turnpiece operates bolt from interior only
- Automatically locked when fully extended

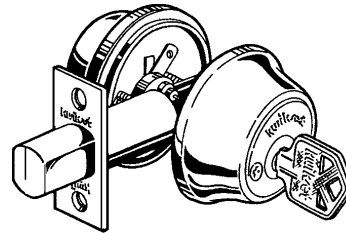

Kwikset.
CORPORATION

Item #	U/M	Finish	Backset / Latch	Strike
M31456	Each	Polished Brass	Adjustable - Square Corner	2-3/4" - Square Corner
M31457	Each	Antique Brass	Adjustable - Square Corner	2-3/4" - Square Corner
M31458	Each	Satin Chrome	Adjustable - Square Corner	2-3/4" - Square Corner

Double Cylinder Deadbolt :

- A standard quality crafted 1" deadbolt offers extra protection at an economical price
- Uses key from either exterior or interior to retract deadbolt
- Ideal for doors with glass areas

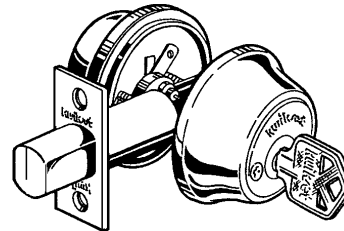

Kwikset.
CORPORATION

Item #	U/M	Finish	Backset / Latch	Strike
M31465	Each	Polished Brass	Adjustable - Square Corner	2-3/4" - Square Corner
M31466	Each	Antique Brass	Adjustable - Square Corner	2-3/4" - Square Corner
M31467	Each	Satin Chrome	Adjustable - Square Corner	2-3/4" - Square Corner

Deadbolts - Specifications & Technical Information

Deadbolt Demensions								
	Cylinder	A	B	C	D	E	F	
	Single	2-1/2"	1-1/8"	2-1/2"	1"	3/8"	1-3/4"	
Double	2-1/2"	1-1/8"	2-1/2"	1-1/8"	N/A	N/A		

	Single & Double Cylinder Deadbolts
Door Prep	Crossbore 2-1/8" Edge Bore 1" Latch Face 1" x 2-1/4"
Backset	2-3/8" or 2-3/4" Adjustable
Door Thickness	1-3/8" - 1-3/4" Doors Standard
Cylinder	5-Pin
Faceplates	1" x 2-1/4" Square Corner Standard
Strikes	2-1/4" Square Corner Standard
Bolt	1" Throw
Door Handing	Reversible For Right or Left Hand Doors
ANSI/BHMA	A156.5 Grade 3

Finishes	
US3	Polished Brass
US5	Antique Brass
US26D	Satin Chrome

	Cylinder	Type / Function
	Single	Single Cylinder: Deadbolt operated by key outside and thumbturn inside.
	Double	Double Cylinder: Deadbolt operated by key both sides.



MILL SUPPLY CO., INC.

Phone (410) 485-3343
Fax (410) 325-2240

Toll Free 1-800-817-8183

Hardware

KWIKSET COMMERCIAL LEVERS / TRIM ROSETTES

Kingston Commercial Lever :

- Grade 2 lever
- Reversible for left or right hand applications
- Available in Polished Brass or Satin Chrome
- U.L. Approved
- A.D.A. Approved

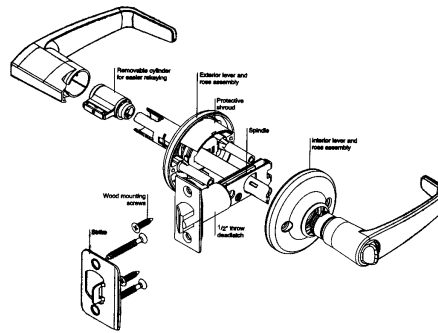

Kwikset
CORPORATION



Item #	U/M	Description	Finish	Backset / Latch	Strike
M31525	Each	Entry Lock	Polished Brass	2-3/4" - Square Corner	2-5/8" - "T" Square Corner
M31527	Each	Entry Lock	Satin Brass	2-3/4" - Square Corner	2-5/8" - "T" Square Corner
M31529	Each	Vestibule Lock	Polished Brass	2-3/4" - Square Corner	2-5/8" - "T" Square Corner
M31531	Each	Vestibule Lock	Satin Brass	2-3/4" - Square Corner	2-5/8" - "T" Square Corner
M31533	Each	Passage Lock	Polished Brass	2-3/4" - Square Corner	2-5/8" - "T" Square Corner
M31535	Each	Passage Lock	Satin Brass	2-3/4" - Square Corner	2-5/8" - "T" Square Corner

Kwikset Commercial Levers - Specifications & Technical Information

Lever Dimensions					
	Design	A	B	C	D
	Kingston	2-5/8"	3-11/16"	3-5/8"	1/2"

Finishes	
US3 US26D	Polished Brass Satin Chrome

	Kingston
Door Prep	Crossbore 2-1/8" Edge Bore 1" x 2-1/4"
Backset	2-3/4"
Door Thickness	1-3/8" - 1-3/4" Doors Standard
Cylinder	5-Pin
Faceplates	1" x 2-1/4" - Square Corner Standard
Strikes	2-5/8" Steel "T" Standard
Bolt	1/2" Throw
Door Handing	Reversible For Right or Left Hand Doors
ANSI/BHMA	Grade 2

	Model	Type / Function
	409	Keyed Entry Lever: Outside locked or unlocked by key outside or turnbutton inside. Inside always free.
	412	Storeroom/Vestibule: Outside unlocked only while key is turned. Inside always free.
	420	Passage/Hall/Closet: Both knobs always free.

Combo Trim Rosette :

- Designed for use with any Kwikset Knob design or lever
- 3-1/2" x 8-1/2"
- Knobs not included

Item #	U/M	Type
M32515	Each	Pol. Brass
M32516	Each	Sat. Chrome
M32517	Each	Ant. Brass

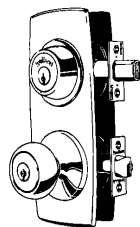

Kwikset
CORPORATION

Handle Trim #239 :

- Polished Brass finish
- 12" Long curved handle adds a touch of class to any entrance way
- Knob not included



Kwikset
CORPORATION

Item # M32501
U/M - Each



MILL SUPPLY CO., INC.

Phone (410) 485-3343
Fax (410) 325-2240

Toll Free 1-800-817-8183

Hardware

Hardware

KWIKSET - DEADBOLTS / HANDLESET / STRIKES

Single Cylinder Deadbolt :

Kwikset
CORPORATION

- Commercial deadbolt
- 6 Pin removable core cylinder
- Adjustable backset
- 1" Throw
- Meets all grade 2 Specs.
- Square corner latch and strike

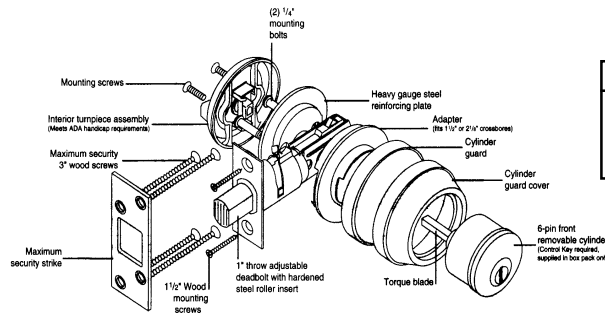

Item #	U/M	Finish
M31616	Each	Polished Chrome
M31617	Each	Polished Brass
M31618	Each	Antique Brass

Handlesets :

Kwikset
CORPORATION

- A stylish scroll-shaped interior lever that adds beauty and richness to the home. Extremely dramatic when used side by side on double doors.
- Polished brass finish
- Meets all grade 2 specs.
- 6 Pin deadbolt with adjustable backset
- Square corner latches and strikes
- 1" Throw on deadbolt
- 1/2" Throw on handle

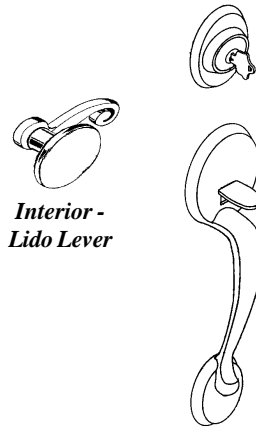

- Handlesets must be ordered right or left handed.

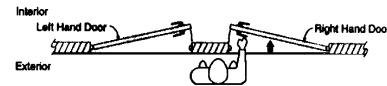

Item #	U/M	Hand
M31598	Each	Left Hand
M31599	Each	Right Hand

Strikes :

Kwikset
CORPORATION

- Sold by the each
- Screws included

2-1/4" Overall height

Latch strikes



Square corner

Radius corner

Item #	Item #	U/M	Finish
Square Corner	Radius Corner		
M32402	M32416	Each	Polished Chrome
M32403	M32417	Each	Polished Brass
M32405	M32418	Each	Antique Brass

2-5/8" Overall height

Latch strike



Item #	U/M	Finish
M32433	Each	Polished Chrome
M32434	Each	Polished Brass
M32435	Each	Antique Brass

2-3/4" Overall height

Deadbolt strike



Item #	U/M	Finish
M32451	Each	Polished Chrome
M32452	Each	Polished Brass
M32453	Each	Antique Brass

4-7/8" Overall height

Latch strike



Item #	U/M	Finish
M39713	Each	Polished Chrome
M39715	Each	Polished Brass



MILL SUPPLY CO., INC.

Phone (410) 485-3343
Fax (410) 325-2240

Toll Free 1-800-817-8183

Hardware

LOCK SERVICES - KEYING OPTIONS

We can professionally key locks to your specifications - Please contact your sales representative for more information.

Keyed Different

Where 2 or more locks have different keys. Keys will not open any other lockset.

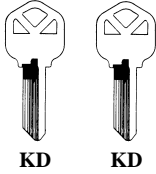

Keyed Alike

Where 2 or more locks are keyed the same. Keys will open either lockset.

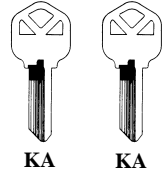

Builder (Construction) Keyed Different

Where 2 or more locks have different keys. Keys will not open any other lockset. Builder key will open all locks in group until tenant key is used. **Once tenant key is used builder key becomes obsolete and will not operate either lockset.**

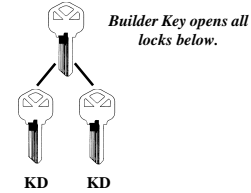

Master Keyed Keyed Different

Where 2 or more locks have different keys. Keys will not open any other lockset but Master key will open either lockset.

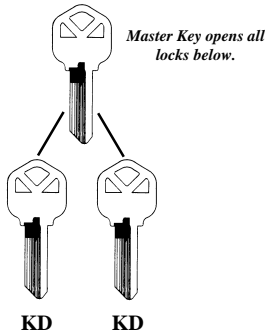

Master Keyed Keyed Alike

Where 2 or more groups have different keys. Keys will not open any other lockset but in there group. Master key will open all locks in either group.

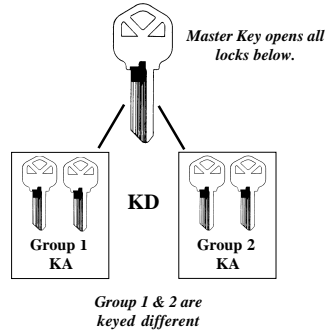

Builder (Construction) Keyed Alike

Where 2 or more groups have different keys. Keys will not open any other lockset. Builder key will open all locks in group until tenant key is used. **Once tenant key is used builder key becomes obsolete and will not operate either lockset.**

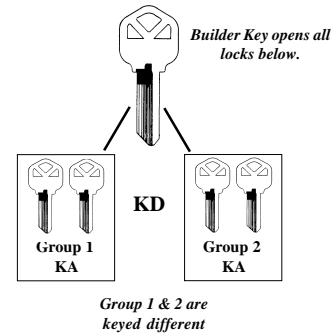

Grand Master Keyed

Where any lock in the system can be opened by one grand master key. In a grand master key system, master keys can open groups within them in the system but will not open locks under a different master key. Groups can be keyed alike or different but will not operate outside of their group.

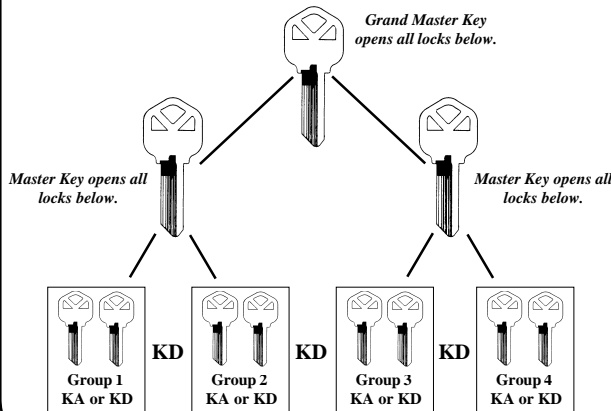

Builder (Construction) Master or Grand Master Keyed

Where any lock in the system can be opened by one grand master key. In a builder grand master key system, master keys can open groups within them in the system but will not open locks under a different master key. Groups can be keyed alike or different but will not operate outside of their group. **Once the tenant key is used, the construction key will no longer operate the lock. The grand master and the master key will always operate the locksets in their specific groups.**

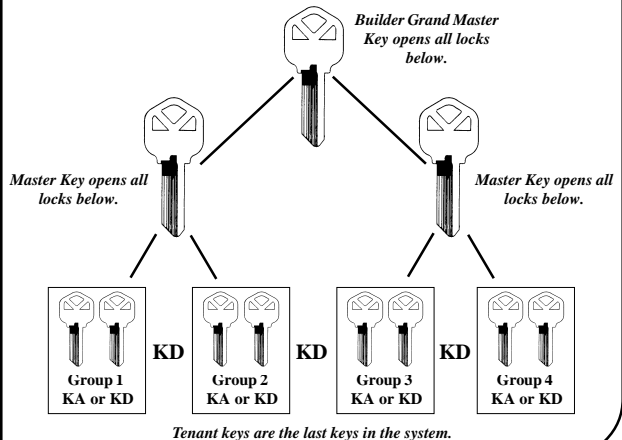

Hardware



MILL SUPPLY CO., INC.

Phone (410) 485-3343
Fax (410) 325-2240

Toll Free 1-800-817-8183

Hardware

KWIKSET LATCHES

Square Corner Deadlatch :

- For entry locks
- 1" Front, 2-1/4" Height
- Available in 2-3/8" or 2-3/4" Backset

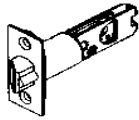

Item #	U/M	B.S.	Finish
M32202	Each	2-3/8"	Satin Chrome
M32203	Each	2-3/8"	Polished Brass
M32204	Each	2-3/8"	Antique Brass
M32206	Each	2-3/4"	Satin Chrome
M32207	Each	2-3/4"	Polished Brass
M32208	Each	2-3/4"	Antique Brass

Radius Corner Deadlatch :

- For entry locks
- 1/4" Radius corner
- 1" Front, 2-1/4" Height
- Available in 2-3/8" or 2-3/4" Backset

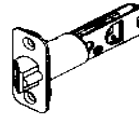

Item #	U/M	B.S.	Finish
M32219	Each	2-3/8"	Polished Chrome
M32220	Each	2-3/8"	Polished Brass
M32221	Each	2-3/8"	Antique Brass
M32225	Each	2-3/4"	Polished Brass

Convertible Deadlatch :

- For entry locks
- Adjustable for 2-3/8" or 2-3/4" Backsets
- Includes both square corner and 1/4" radius corner front plates
- 1" Front, 2-1/4" Height
- Polished Brass finish

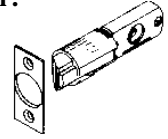

Item # M32231
U/M - Each

Drive-In Deadlatch :

- For entry locks
- 1" Diameter
- Available in 2-3/8" or 2-3/4" Backset

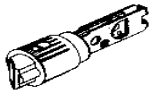

Item #	U/M	B.S.	Finish
M32236	Each	2-3/8"	Die Cast Brass
M32242	Each	2-3/4"	Die Cast Brass

Square Corner Latch :

- For interior locks
- 1" Front, 2-1/4" Height
- Available in 2-3/8" or 2-3/4" Backset

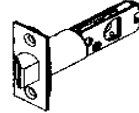

Item #	U/M	B.S.	Description
M32249	Each	2-3/8"	Polished Chrome
M32250	Each	2-3/8"	Polished Brass
M32251	Each	2-3/8"	Antique Brass
M32258	Each	2-3/4"	Polished Chrome
M32259	Each	2-3/4"	Polished Brass
M32260	Each	2-3/4"	Antique Brass

Radius Corner Latch :

- For interior locks
- 1/4" Radius corner
- 1" Front, 2-1/4" Height
- Available in 2-3/8" or 2-3/4" Backset

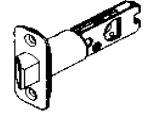

Item #	U/M	B.S.	Finish
M32267	Each	2-3/8"	Polished Chrome
M32268	Each	2-3/8"	Polished Brass
M32269	Each	2-3/8"	Antique Brass

Drive-In Latch :

- For interior locks
- 1" Diameter
- Available in 2-3/8" or 2-3/4" Backset

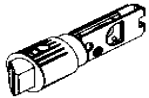

Item #	U/M	B.S.	Finish
M32284	Each	2-3/8"	Die Cast Brass
M32289	Each	2-3/4"	Die Cast Brass

Looking for strikes ?
Page 126

Lock installation kit
Page 54

Pre-Hung doors
Page 167

Square Corner Deadbolt Latch :

- For Titan deadbolts
- 1" Front, 2-1/4" Height
- For use with 580, 630, 780 and 880 series deadbolts

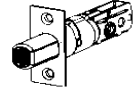

Item #	U/M	B.S.	Finish
M32292	Each	Adj.	Polished Chrome
M32293	Each	Adj.	Polished Brass
M32294	Each	Adj.	Antique Brass

Square Corner Deadbolt Latch :

- For Kwikset deadbolts
- 1" Front, 2-1/4" Height
- For use with 660 series deadbolts

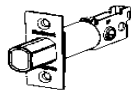

Item #	U/M	B.S.	Description
M32305	Each	2-3/8"	Satin Chrome
M32306	Each	2-3/8"	Polished Brass
M32307	Each	2-3/8"	Antique Brass
M32312	Each	2-3/4"	Satin Chrome
M32313	Each	2-3/4"	Polished Brass
M32314	Each	2-3/4"	Antique Brass

Radius Corner Deadbolt Latch :

- For Kwikset deadbolts
- 1" Front, 2-1/4" Height
- 1/4" Radius corner
- For use with 660 series deadbolts
- Available in 2-3/8" or 2-3/4" Backset

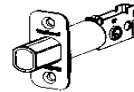

Item #	U/M	B.S.	Finish
M32323	Each	2-3/8"	Polished Brass
M32331	Each	2-3/4"	Polished Brass

Drive-In Deadbolt Latch :

- For Kwikset deadbolts
- 1" Diameter, 2-1/4" Height
- For use with 660 series deadbolts
- Available in 2-3/8" or 2-3/4" Backset

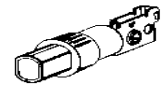

Item #	U/M	B.S.	Finish
M32339	Each	2-3/8"	Polished Brass
M32347	Each	2-3/4"	Polished Brass



MILL SUPPLY CO., INC.

Phone (410) 485-3343
Fax (410) 325-2240

Toll Free 1-800-817-8183

Hardware

KWIKSET ACCESSORIES

Installation Jig :

- OEM # 108

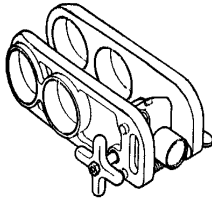

Item # M32101
U/M - Each

Installation Kit :

- OEM # 136

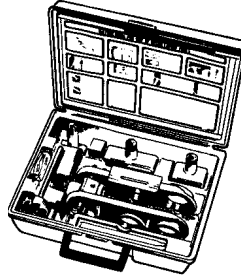

Item # M32102
U/M - Each

Key Gauge :

- OEM # 049

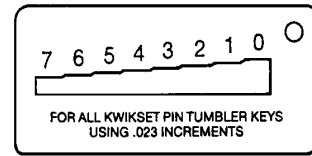

Item # M32068
U/M - Each

Cylinder Removal Tool :

- OEM # 1467



Item # M32067
U/M - Each

Plug Following Tool :

- OEM # 152



Item # M32065
U/M - Each

Deadlock Tongue Blade :

- OEM # 4991

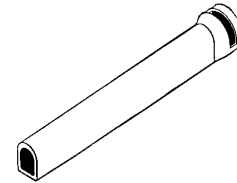

Item # M32062
U/M - Each

Kwikset Plug Chip :

- OEM # 4345



Item # M32071
U/M - Each

Deadlock Plug Chip :

- OEM # 4215



Item # M32070
U/M - Each

Replacement Cylinder :

- OEM # 1850

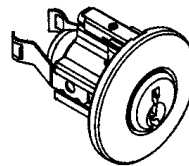

Item #	U/M	Type
M32075	Each	Pol. Brass
M32076	Each	Sat. Chrome
M32077	Each	Ant. Brass

Pin Cover Cap :

- 50/pk

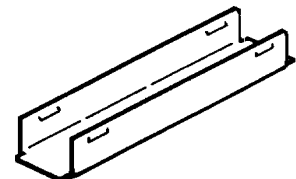

Item #	U/M	Type
M32035	Pack	5-Pin
M32036	Pack	6-Pin



MILL SUPPLY CO., INC.

Phone (410) 485-3343
Fax (410) 325-2240

Item # M32075
U/M - Each

Toll Free 1-800-817-8183

Hardware

Hardware

SCHLAGE LOCKSETS

Plymouth Design :

- Meets all Grade 2 Specs.
- Polished brass finish
- Adjustable backset & latch
- Ultima bright brass lifetime finish

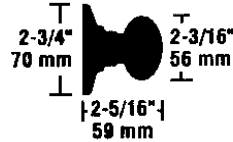
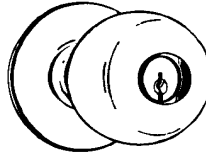

SCHLAGE
Residential Security & Safety

Item #	U/M	Description	Finish	Backset / Latch	Strike
M33453	Each	Passage	Polished Brass	Adjustable	2-1/4" Square Corner
M33454	Each	Privacy	Polished Brass	Adjustable	2-1/4" Square Corner
M33455	Each	Dummy	Polished Brass	Adjustable	2-1/4" Square Corner
M33456	Each	Entry	Polished Brass	Adjustable	2-1/4" Square Corner
M33457	Each	Vestibule	Polished Brass	Adjustable	2-1/4" Square Corner

Plymouth Design Entrance Handleset :

- Single cylinder deadbolt
- Meets all Grade 2 Specs.
- Latch and throw both adjustable for 2-3/8" and 2-3/4" doors
- Ultima bright brass lifetime finish

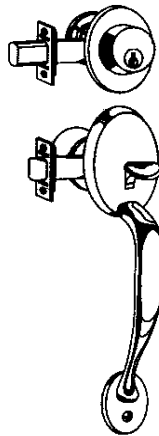

SCHLAGE
Residential Security & Safety

Item # M33459
U/M - Each

Flair Design :

- Meets all Grade 2 Specs.
- Polished brass finish
- Adjustable backset & latch
- Ultima bright brass lifetime finish
- **Flair levers must be ordered right or left handed.**

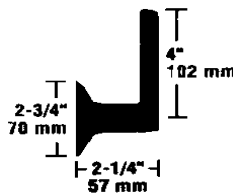

SCHLAGE
Residential Security & Safety

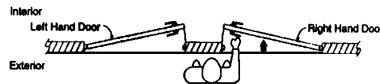

Item #	U/M	Description	Handing	Finish	Backset / Latch	Strike
M33470	Each	Passage	LH	Polished Brass	Adjustable	2-1/4" Square Corner
M33471	Each	Passage	RH	Polished Brass	Adjustable	2-1/4" Square Corner
M33472	Each	Privacy	LH	Polished Brass	Adjustable	2-1/4" Square Corner
M33473	Each	Privacy	RH	Polished Brass	Adjustable	2-1/4" Square Corner
M33474	Each	Dummy	LH	Polished Brass	N/A	N/A
M33475	Each	Dummy	RH	Polished Brass	N/A	N/A



MILL SUPPLY CO., INC.

Phone (410) 485-3343
Fax (410) 325-2240

Toll Free 1-800-817-8183

Hardware

SCHLAGE LOCKSETS

Elan Design :

- Meets all Grade 2 Specs.
- Polished brass finish
- Adjustable backset & latch
- Ultima bright brass lifetime finish
- Reversible for left or right hand application

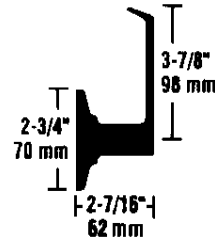
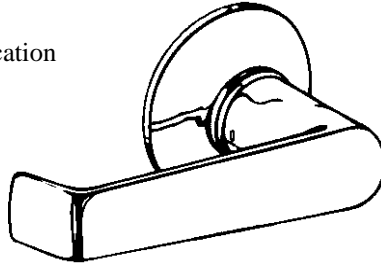

Item #	U/M	Description	Finish	Backset / Latch	Strike
M33463	Each	Passage	Polished Brass	Adjustable	2-1/4" Square Corner
M33464	Each	Privacy	Polished Brass	Adjustable	2-1/4" Square Corner
M33465	Each	Dummy	Polished Brass	Adjustable	2-1/4" Square Corner

F-Series - Specifications & Technical Information Plymouth / Flair / Elan

-	Standard Features
Entrance Handsets	
Certification	ANSI A156.2, 1992, Grade 2. Auxiliary lock
Latch	1" x 2-1/4", 1/4" Radius corner faceplate, 7/8" housing diameter, 1/2" throw springlatch, with Triple Option latch fits square corner, radius corner, round corner or circular drive in applications
Deadbolt	1" x 2-1/4" Radius corner faceplate, 7/8" housing diameter, 1" throw, with Triple-Option latch fits square corner, radius corner, round corner or circular drive-in applications
Strikes	1-5/8" x 2-1/4", Square corner, full lip, no box, latch strike & 1-1/8" square corner, box, deadbolt strike
Reinforcement	Door frame reinforcer with 3" screws
Backset	Universal backset latch & deadbolt, fits either 2-3/8" or 2-3/4" backsets
Cylinder	6-Pin solid brass, keyed 5-Pin, C keyway, keyed different
Door Range	1-5/8" - 1-3/4". Packed with extra mounting screws to accommodate 2" doors
Keys	Four nickel silver cut keys per lock. 5-Pin. C section
Knobs & Levers	
Certification	ANSI A156.2, 1996, Series 4000, Grade 2. Available UL listed for 3 hour fire door
Latch	1" x 2-1/4", Square corner faceplate, 7/8" housing diameter, 1/2" throw, with Triple-Option square corner and circular corner faceplate
Strike	1-5/8" x 2-1/4", square corner, full lip, no box
Backset	Dual backset latches, fits either 2-3/8" or 2-3/4" backsets
Cylinder	5-Pin, C keyway, keyed different
Door Range	1-3/8" - 1-3/4"
Keys	Two nickel silver cut keys per lock, 5-Pin, C section



MILL SUPPLY CO., INC.

Phone (410) 485-3343
Fax (410) 325-2240

Toll Free 1-800-817-8183

Hardware

Hardware

SCHLAGE LOCKSETS

Saturn Design :

- Meets all Grade 2 Specs.
- UL Listed for 3 hour fire door
- Adjustable backset & latch
- Available in polished brass or satin chrome finish
- Reversible for left or right hand doors



SCHLAGE
Residential Security & Safety



Item #	U/M	Description	Finish	Backset / Latch	Strike
M33481	Each	Passage	Polished Brass	Adjustable	Square T-Strike
M33482	Each	Passage	Satin Chrome	Adjustable	Square T-Strike
M33483	Each	Privacy	Polished Brass	Adjustable	Square T-Strike
M33484	Each	Privacy	Satin Chrome	Adjustable	Square T-Strike
M33485	Each	Dummy	Polished Brass	Adjustable	Square T-Strike
M33486	Each	Dummy	Satin Chrome	Adjustable	Square T-Strike

Jupiter Design :

- Meets all Grade 2 Specs.
- UL Listed for 3 hour fire door
- Adjustable backset & latch
- Available in polished brass or satin chrome finish
- Reversible for left or right hand doors



SCHLAGE
Residential Security & Safety



Item #	U/M	Description	Finish	Backset / Latch	Strike
M33491	Each	Passage	Polished Brass	Adjustable	Square T-Strike
M33492	Each	Passage	Satin Chrome	Adjustable	Square T-Strike
M33493	Each	Privacy	Polished Brass	Adjustable	Square T-Strike
M33494	Each	Privacy	Satin Chrome	Adjustable	Square T-Strike
M33495	Each	Dummy	Polished Brass	Adjustable	Square T-Strike
M33496	Each	Dummy	Satin Chrome	Adjustable	Square T-Strike

Schlage Levers - Specifications & Technical Information

Knob Demensions				
	Design	A	B	C
	Saturn	2-9/16"	4-1/4"	2-1/2"
	Jupiter	2-9/16"	4-1/4"	2-1/2"

-	Standard Features
Certification	ANSI A156.2, 1996, Series 4000, Grade 2, UL Listed for 3 hour fire door
Latch	1" x 2-1/4", Square corner faceplate, 7/8" housing diameter, 1/2" throw
Strike	1-1/8" x 2-3/4", Square corner, T-Strike, box
Backset	Dual backset latch, fits either 2-3/8" or 2-3/4" backsets
Cylinder	6-Pin solid brass, keyed 5-Pin, C Keyway, keyed different
Door Range	1-3/8" - 2"
Keys	Two nickel silver cut keys per lock, 5-Pin, C section

Finishes	
US3	Polished Brass
US26D	Satin Chrome



MILL SUPPLY CO., INC.

Phone (410) 485-3343
Fax (410) 325-2240

Toll Free 1-800-817-8183

Hardware

SCHLAGE LOCKSETS

Saturn Design :

- Meets all Grade 2 Specs.
- Single and multi-family residential, office hotel/motel and commercial applications
- Simultaneous latch and bolt retraction for rapid exit
- UL Listed for 3 hour fire door
- Available in polished brass or satin chrome finish
- Reversible for left or right hand doors

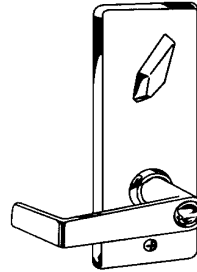

Item #	U/M	Description	Finish	Backset / Latch
M33514	Each	Passage	Polished Brass	2-3/8"
M33515	Each	Passage	Satin Chrome	2-3/8"
M33516	Each	Entry	Polished Brass	2-3/8"
M33517	Each	Entry	Satin Chrome	2-3/8"

Specifications & Technical Information

Finishes	
US3	Polished Brass
US26D	Satin Chrome

-	Standard Features
Certification	ANSI A156.12, 1992, Grade 2, UL Listed for 3 hour fire door
Deadbolt	1-1/8" x 2-1/8", Square corner faceplate, 1" housing diameter, 1" throw
Deadlatch	1-1/8" x 2-1/4", Square corner faceplate, 1" housing diameter, 1/2" throw
Strikes	1-1/8" x 2-3/4", Square corner, box (deadbolt) and 1-1/8" x 2-3/4", Square corner, T-Strike, box (deadlatch)
Reinforcement	Door frame strike reinforcer with 3" screws
Backset	2-3/8"
Cylinder(s)	6-Pin upper cylinder and 6-Pin lower cylinder, solid brass, C keyway, keyed different - upper and lower cylinders are keyed alike
Door Range	1-3/8" - 2"
Keys	Two nickel silver cut keys per lock, 5-Pin, C section

BC Series Deadbolts :

- Meets all Grade 2 Specs.
- Adjustable for 2-3/8" or 2-3/4" backsets
- Features a 1" throw, with a concealed hardened steel roller to prevent cutting or sawing the bolt
- UL Listed for 3 hour fire door
- The 1" reinforced trim ring rotates to protect against wrenching the cylinder
- Solid brass 6-pin cylinder for added protection and durability
- Solid steel door frame reinforcer with 1/4" steel screws protect against kick-in attack



Item #	U/M	Description	Finish	Backset / Latch
M33522	Each	Single Cylinder	Polished Brass	Adjustable
M33528	Each	Single Cylinder	Satin Chrome	Adjustable
M33529	Each	Double Cylinder	Polished Brass	Adjustable
M33530	Each	Double Cylinder	Satin Chrome	Adjustable



MILL SUPPLY CO., INC.

Phone (410) 485-3343
Fax (410) 325-2240

Toll Free 1-800-817-8183

Hardware

Hardware

Jimmyproof #1200 Single Cylinder Lock :

ILCO UNICAN.

- #04 Satin brass finish
- Keyed different
- X1014F keyway
- Available with flat or angled strike

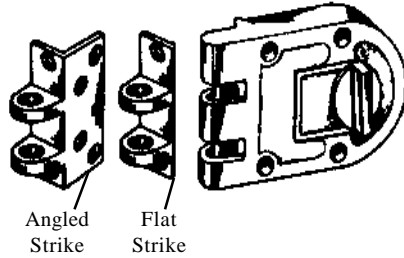

Item #	U/M	Strike
M33556	Each	Flat
M33559	Each	Angled

Jimmyproof #1250 Double Cylinder Lock :

ILCO UNICAN.

- #04 Satin brass finish
- Keyed different
- HR1 keyway
- Angled strike

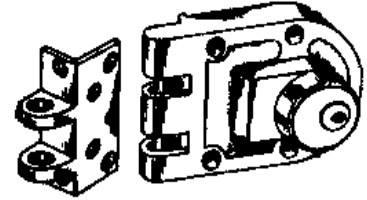

Item # M33565
U/M - Each

Rim Deadlock #545 :

ILCO UNICAN.

- #54 Brass lacquer finish
- Keyed different
- IN35 keyway
- Angled strike

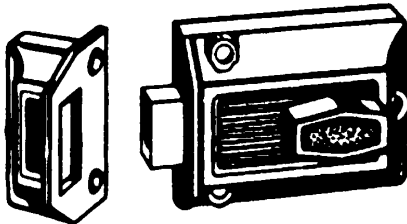

Item # M33568
U/M - Each

Night Latch #3000 :

ILCO UNICAN.

- #04 Satin brass finish
- **Does not include cylinder**
- Angled strike

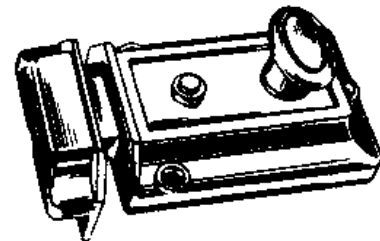

Item # M33580
U/M - Each

Rim Cylinders Die Cast :

ILCO UNICAN.

- All have EA27 keyway
- A low cost alternative to solid brass cylinders
- Replacement key blank #M3400

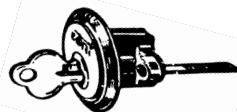

Item #	U/M	Finish	Keyway
M33589	Each	Satin Brass	Differ...
M33586	Each	Satin Brass	Alike #3030
M33595	Each	Satin Aluminum	Alike #3030

Rim Cylinders Solid Brass :

ILCO UNICAN.

- Available in several keyways and finishes

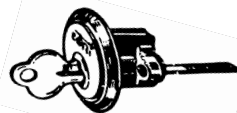

Item #	U/M	Finish	Keyway	Replacement Keyblank #
M33628	Each	Satin Alum.	Schlage SC1	M34136
M33637	Each	Bright Brass	Schlage SC1	M34136
M33622	Each	Satin Alum.	Yale Y1	M34178
M33619	Each	Bright Brass	Yale Y1	M34178
M33625	Each	Satin Alum.	Kwikset KW1	M34060
M33640	Each	Bright Brass	Kwikset KW1	M34060

Mortise Cylinders :

ILCO UNICAN.

- Available in several keyways and finishes



Item #	U/M	Finish	Keyway	Replacement Keyblank #
M33464	Each	Satin Alum.	Schlage SC1	M34136
M33643	Each	Bright Brass	Schlage SC1	M34136
M33652	Each	Satin Alum.	Yale Y1	M34178
M33661	Each	Bright Brass	Yale Y1	M34178
M33660	Each	Satin Alum.	Kwikset KW1	M34060
M33658	Each	Bright Brass	Kwikset KW1	M34060



MILL SUPPLY CO., INC.

Phone (410) 485-3343
Fax (410) 325-2240

Toll Free 1-800-817-8183

Hardware

KEYING KITS/KEY MACHINES

Kwikset
CORPORATION

Generic Keying For Kwikset :

- Contains the parts necessary to re-key and master key Kwikset knobs, deadbolts and leversets



Item # M34270
U/M - Each

Kwikset Keying Kit # 271 :

Kwikset
CORPORATION

- Contains the parts necessary to re-key and master key Kwikset knobs, deadbolts and leversets



Item # M32003
U/M - Each

Kwikset Pins & Springs :

- Sold in packs of 100 only

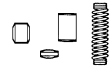

Item #	U/M	Mfg. #	Description
M32010	Pack	3100	#1 Bottom pin
M32011	Pack	3101	#2 Bottom pin
M32012	Pack	3103	#3 Bottom pin
M32013	Pack	3105	#4 Bottom pin
M32014	Pack	3106	#5 Bottom pin
M32015	Pack	3107	#6 Bottom pin
M32016	Pack	3108	#1 Master pin
M32017	Pack	3110	#2 Master pin
M32018	Pack	3112	#3 Master pin
M32019	Pack	3113	#4 Master pin
M32020	Pack	3114	#5 Master pin
M32021	Pack	3125	#6 Master pin
M32022	Pack	3117	.160 Driver
M32023	Pack	1858	.180 Driver
M32024	Pack	1777	Tumbler spring

Key Machine # 027 :

ILCO UNICOR

- Minikey, manual, bench model, cuts cylinder keys, direct drive cutter, 110 volt motor

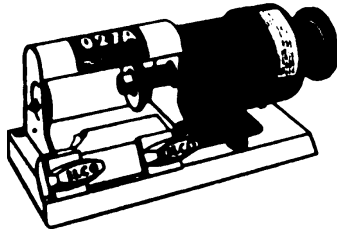

Item # M34256
U/M - Each

Key Machine # 045 :

ILCO UNICOR

- Manual, bench model, cuts cylinder keys, side by side vises, 110 volt motor

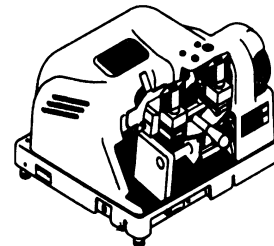

Item # M34253
U/M - Each

Key Machine Accessories

Nylon Brush :

ILCO UNICOR

- Fits both our #027 & #045 machines
- Sold by the each

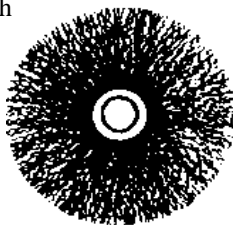

Item # M34264
U/M - Each

Cutter Wheel for Key Cutting Machine :

ILCO UNICOR

- Fits both our #027 & #045 machines
- Sold by the each

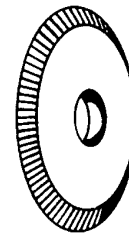

Item # M34267
U/M - Each



MILL SUPPLY CO., INC.

Phone (410) 485-3343
Fax (410) 325-2240

Toll Free 1-800-817-8183

Hardware

Hardware

KEY BLANKS

Arrow Key Blank :

- Sold by the box of 50

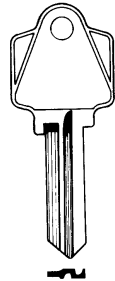

ESP # AR1
Ilco # 1179

Item # M34017
U/M - Box

Dexter Key Blank :

- Sold by the box of 50

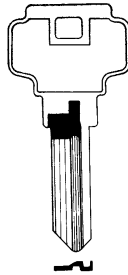

ESP # DE6
Ilco # D1054K

Item # M34028
U/M - Box

Eagle Key Blank :

- Sold by the box of 50

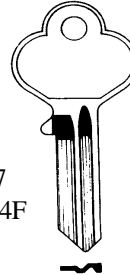

ESP # EA27
Ilco # X1014F

Item # M34035
U/M - Box

ESP Key Blank :

- Sold by the box of 50

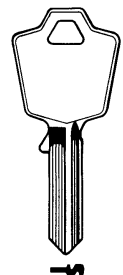

ESP # ES9
Ilco # 1503

Item # M34039
U/M - Box

Hudson Key Blank :

- Sold by the box of 50

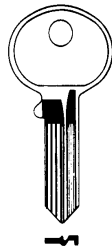

ESP # HL1

Item # M34042
U/M - Box

Hudson Key Blank :

- Sold by the box of 50

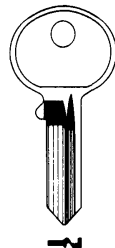

ESP # HL2

Item # M34046
U/M - Box

Ilco Key Blank :

- Sold by the box of 50

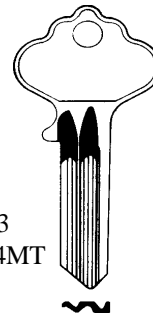

ESP # IN33
Ilco # 1054MT

Item # M34053
U/M - Box

Ilco Key Blank :

- Sold by the box of 50

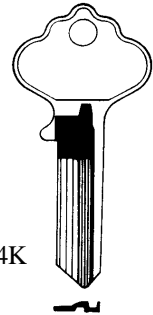

ESP # IN3
Ilco # X1054K

Item # M34054
U/M - Box

Kwikset Key Blank :

- Sold by the box of 50
- 5 pin

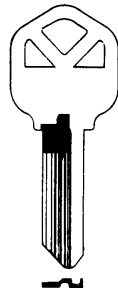

ESP # KW1
Ilco # 1176

Item # M34060
U/M - Box

Kwikset Key Blank :

- Sold by the box of 50
- 6 pin

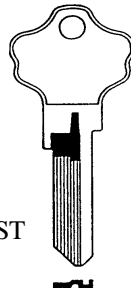

ESP # KW10
Ilco # A1176ST

Item # M34067
U/M - Box

Lockwood Key Blank :

- Sold by the box of 50



ESP # L1
Ilco # 1004

Item # M34074
U/M - Box

Master Key Blank :

- Sold by the box of 50

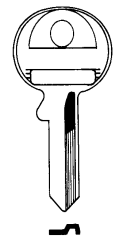

ESP # M1
Ilco # 1092

Item # M34081
U/M - Box



MILL SUPPLY CO., INC.

Phone (410) 485-3343
Fax (410) 325-2240

Toll Free 1-800-817-8183

Hardware

KEY BLANKS

National Key Blank :

- Sold by the box of 50

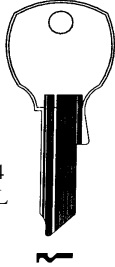

ESP # NA14
Ilco # 1069L

Item # M34105
U/M - Box

National Key Blank :

- Sold by the box of 50

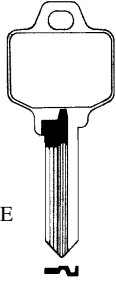

ESP # NA6
Ilco # R1064E

Item # M34098
U/M - Box

National Key Blank :

- Sold by the box of 50

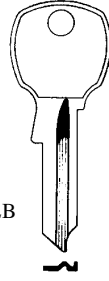

ESP # NA12
Ilco # 1069LB

Item # M34101
U/M - Box

Russwin Key Blank :

- Sold by the box of 50

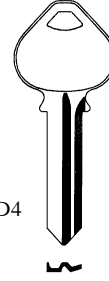

ESP #
Ilco # A1011D4

Item # M34003
U/M - Box

Russwin Key Blank :

- Sold by the box of 50

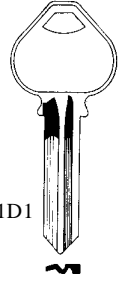

ESP # RU46
Ilco # A1011D1

Item # M34122
U/M - Box

Sargent Key Blank :

- Sold by the box of 50

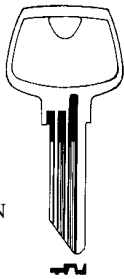

ESP # 568
Ilco # 1010N

Item # M34133
U/M - Box

Schlage Key Blank :

- Sold by the box of 50

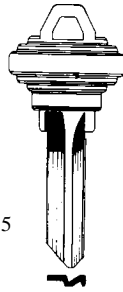

ESP # SC1
Ilco # 1145

Item # M34136
U/M - Box

Schlage Key Blank :

- Sold by the box of 50

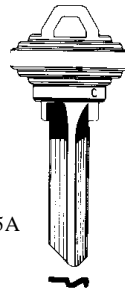

ESP # SC4
Ilco # 1145A

Item # M34140
U/M - Box

Schlage Key Blank :

- Sold by the box of 50

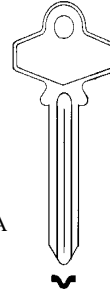

ESP # SC6
Ilco # 1307A

Item # M34143
U/M - Box

Schlage Key Blank :

- Sold by the box of 50

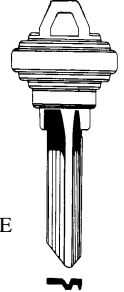

ESP # SC8
Ilco # 1145E

Item # M34150
U/M - Box

Schlage Key Blank :

- Sold by the box of 50

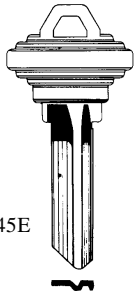

ESP # SC9
Ilco # A1145E

Item # M34153
U/M - Box

Schlage Key Blank :

- Sold by the box of 50

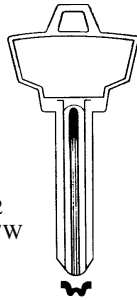

ESP # SC22
Ilco # 1307W

Item # M34157
U/M - Box

Weiser Key Blank :

- Sold by the box of 50

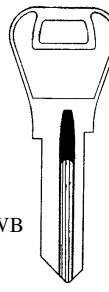

ESP # WR3
Ilco # 1054WB

Item # M34168
U/M - Box

Weiser Key Blank :

- Sold by the box of 50

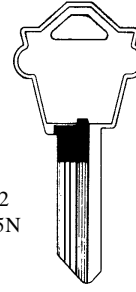

ESP # WK2
Ilco # 1175N

Item # M34165
U/M - Box

Yale Key Blank :

- Sold by the box of 50

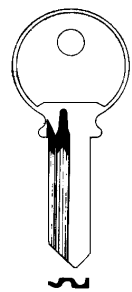

ESP # Y1
Ilco # 999

Item # M34178
U/M - Box



MILL SUPPLY CO., INC.

Phone (410) 485-3343
Fax (410) 325-2240

Toll Free 1-800-817-8183

Hardware

Hardware

KEY CABINETS/DOOR HARDWARE

Key Cabinets :

- Sturdy welded steel construction
- Precision spot welded end caps and double reinforced door corners prevent prying
- Key strips have smooth corners and edges to prevent snagging
- Can be mounted flush or recessed
- Sand color

MMF
INDUSTRIES

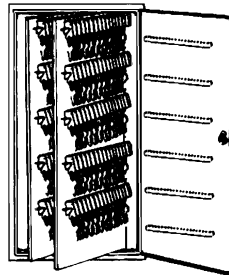

Item #	U/M	Capacity
M34294	Each	60
M34297	Each	110
M34301	Each	160
M34304	Each	240

Key Tags :

MMF
INDUSTRIES

- Can be used in key cabinets or on hooks
- Chrome plated snap hook accommodates one or more keys
- Sold by the pack of 20 only

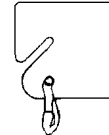

Item # M34281
U/M - Pack

Key Tags :

- Can be used in key cabinets or on hooks
- Nylon rope accommodates one or more keys
- Paper tag with chrome ring
- Sold by the box of 100 only

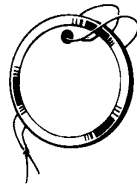

Item # M34286
U/M - Box

Wrap Around For 2-3/8" Backset Door :

- For doors with 2-1/8" hole
- Built in stainless steel insert
- Dimensions 4" x 9"

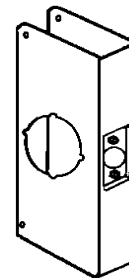

Item #	U/M	Finish	Door
M41159	Each	Brass	1-3/8"
M41162	Each	Chrome	1-3/8"
M41165	Each	Brass	1-3/4"
M41168	Each	Chrome	1-3/4"

Wrap Around for Deadbolts :

- For deadbolts with 2-1/8" hole
- Built in stainless steel threaded insert
- Dimensions for wrap that fits 2-3/8" backset: 4" x 4-1/2"
- Dimensions for wrap that fits 2-3/4" backset: 4-1/4" x 4-1/2"

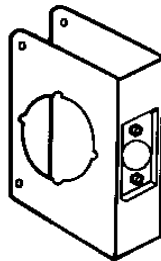

Item #	U/M	Back Set	Door	Finish
M41186	Each	2-3/8"	1-3/8"	Brass
M41189	Each	2-3/8"	1-3/8"	Chrome
M41192	Each	2-3/8"	1-3/4"	Brass
M41195	Each	2-3/8"	1-3/4"	Chrome
M41201	Each	2-3/4"	1-3/4"	Brass
M41204	Each	2-3/4"	1-3/4"	Chrome

Wrap Around For 2-3/4" Backset Door :

- For doors with 2-1/8" hole
- Built in stainless steel insert
- Dimensions 4-1/4" x 9"

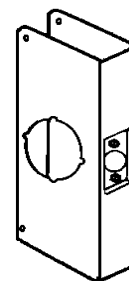

Item #	U/M	Door	Finish
M41171	Each	1-3/8"	Brass
M41174	Each	1-3/8"	Chrome
M41180	Each	1-3/4"	Brass
M41183	Each	1-3/4"	Chrome



MILL SUPPLY CO., INC.

Phone (410) 485-3343
Fax (410) 325-2240

Toll Free 1-800-817-8183

Hardware

DOOR HARDWARE

Door Closers :

- Easy surface mounted installation
- Universal application, non-handed for standard, top jamb, parallel or corner bracket installation
- Narrow design permits installation on most modern glass and aluminum doors without adapters
- Closing and latching speed controlled by two regulating valves fully adjustable after installation
- Rack and pinion mechanism contained in high tensile precision housing assures the highest
- #4 closer size rated for 121-187 lb. doors

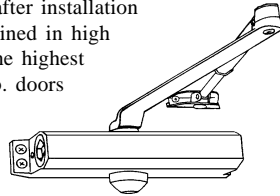

Item#	U/M	Finish
M39656	Each	Aluminum
M39657	Each	Bronze

Latch Protector :

- Aluminum finish steel
- Aluminum powder coated finish
- Weather resistant
- Solid single piece heavy gauge steel construction
- For single, outswinging doors
- Covers strike plate of key-in-knob or mortise locks
- Includes all mounting hardware
- 3" W x 11" L



Item # M33553
U/M - Each

Surface Bolt :

- Solid brass, polished brass finish
- Furnished with surface and mortise strikes
- Features extruded solid brass construction
- Excellent for fixed doors and regular doors
- Furnished with screws
- Size 4"

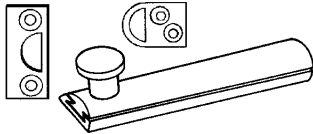

Item # M34890
U/M - Each

Door Edge Pull :

- Solid brass construction
- Lacquered polished brass finish
- 3/4" W x 3-7/8" L x 1-7/16" H
- Back plate included
- Furnished with screws



Item # M34994
U/M - Each

Ball Catches "Drive In" :

- Polished brass finish
- Adjustable tension ball
- For wood or metal doors
- 7/8" body diameter, 1-3/16" body length
- Strike plate is 1-1/8" x 1-11/16"

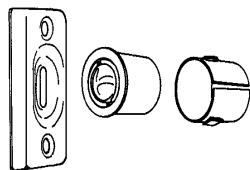

Item # M34831
U/M - Each

Magnetic Door Catch :

- For wardrobe or closet doors
- High power magnets
- Small catch packed 2 per polybag
- Furnished with screws
- Brass finish

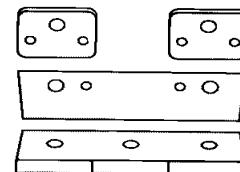

Item # M34870
U/M - Each



MILL SUPPLY CO., INC.

Phone (410) 485-3343
Fax (410) 325-2240

Toll Free 1-800-817-8183

Hardware

DOOR HARDWARE

Address Plates :

- Dimensions 4-1/2" x 12"
- Made of care free, rustproof aluminum

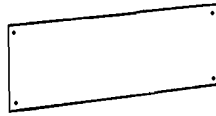

Did you know ?

- We can mount #'s on address plates to your specifications.

Contact you sales representative for more information.

Item#	UM	Finish
M38173	Each	Aluminum
M38182	Each	Brass Tone

Kick Plates :

- For commercial or residential door use
- Prevents scuffing, marking, chipping, and damage to door
- Protection for all types of surfaces
- Made of care free, rustproof aluminum
- Shipped with protective peel-off film mask
- Heavy gauge .040 thick metal
- Furnished with sheet metal screws*

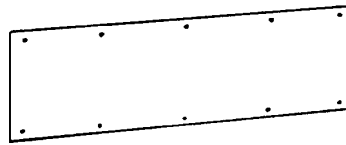

Item #	U/M	Finish	Size	Description
M38128	Each	Brass Tone	6" x 34"	w/ screws
M38130	Each	Sat. Anodized	6" x 34"	w/ screws
M38143	Each	Brass Tone	8" x 34"	Adhesive Back
M38140	Each	Brass Tone	8" x 34"	w/ screws
M38146	Each	Sat. Anodized	8" x 34"	w/ screws

* M38143 has an adhesive back

Push / Pull Plates:

- Both are 3-1/2" x 15"
- Pull plates have a 5/8" diameter handle
- Handle is 5-1/2" CTC



Push Pull

Item#	U/M	Type	Finish
M38206	Each	Push	Anodized Aluminum
M38204	Each	Push	Brass Tone
M38202	Each	Pull	Anodized Aluminum
M38198	Each	Pull	Brass Tone

Surface Hinges :

- Non-Removable Pin
- Must be "welded on"
- Plain steel
- Sold by the each

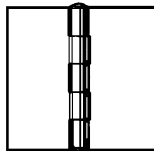

Item#	UM	Size
M18821	Each	2" x 2"
M18825	Each	3" x 3"
M18829	Each	4" x 4"

Square Corner Hinges :

- Standard weight full mortise hinge
- Satin brass finish
- For wood or metal doors
- Button tip - loose pin
- Furnished with phillips fly cut T17 screws
- Template hole pattern
- Sold by the pair of 2 hinges only

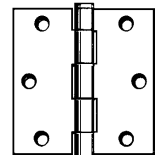

Item#	UM	Size
M18793	Pair	3-1/2" x 3-1/2"
M18801	Pair	4" x 4"



MILL SUPPLY CO., INC.

Phone (410) 485-3343
Fax (410) 325-2240

Toll Free 1-800-817-8183

Hardware

Hardware

DOOR HARDWARE

5/8" Radius Corner Hinges :

- Standard weight full mortise hinges
- For wood or metal doors
- Button tip - loose pin
- Furnished with phillips fly cut T17 screws
- Template hole pattern
- Satin brass finish
- 3-1/2" x 3-1/2"
- Sold by the pair of 2 hinges only

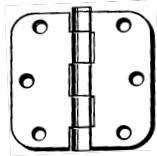

Item # M18785
U/M - Pair

Hand Rail Bracket :

- 3" Projection
- Zinc die cast construction
- Polished brass finish

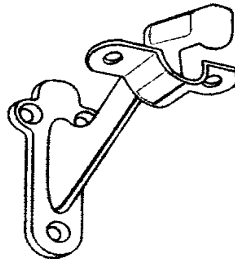

Item # M34824
U/M - Each

Cone Shape Spring Door Stop :

- 3" overall length
- Brass finish with plastic bumper
- Separate screw and base plate for easy installation

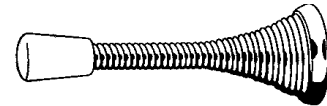

Item # M38317
U/M - Each

Heavy Duty Wall Door Stop :

- 4" overall length
- Heavy duty die cast construction
- Easy to install with self start screw
- Heavy cushion bumper tip



Item#	UM	Finish
M38357	Each	Chrome
M38355	Each	Brass

Heavy Duty Wall Door Stop :

- Heavy duty zinc die cast construction
- Reinforced square shank body
- Easy to install with self start screw



Item#	UM	Finish
M38335	Each	Ant. Brass
M38333	Each	Brass
M38331	Each	Chrome

Spring Door Stop :

- 3" overall length
- Flexible for safe & easy cleaning
- Easy to install with self start screw

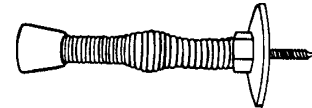

Item#	UM	Finish
M38319	Each	Chrome
M38321	Each	Brass

Deluxe Hinge Pin Door Stop :

- Doorstop is held in place by hinge pin
- Adjustable to stop door at any angle
- Large self adjusting pad makes full contact with door
- Oversize bumper mounted on adjusting screw protects door trim

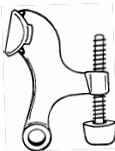

Item # M38227
U/M - Each

Hinge Pin Door Stop :

- Furnished with rubber bumper tips and white plastic bumper
- Adjustable door stop can be set to stop at any desired angle
- Fits pin of any average door hinge
- Polished brass finish

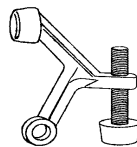

Item # M38311
U/M - Each

Hinge Pin Door Stop :

- Heavy duty steel construction
- Adjustable
- Furnished with plastic bushing and 2 rubber tips
- Brass plated finish

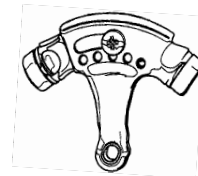

Item # M38279
U/M - Each



MILL SUPPLY CO., INC.

Phone (410) 485-3343
Fax (410) 325-2240

Toll Free 1-800-817-8183

Hardware

Hardware

DOOR HARDWARE

Round Wall Door Stop :

- Zinc die cast construction
- 2-3/8" overall diameter
- Concealed screw mount
- Grey vinyl bumper insert
- Furnished with anchor and screw
- Concave face to fit interior lock button
- Lacquered finish

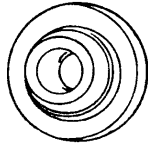

Item #	U/M	Finish
M38369	Each	Chrome
M38371	Each	Brass

Commercial Wall Stop :

- Non-marring bumper
- Cast aluminum construction
- 3-1/2" projection with 2-1/2" base plate
- 3 hole surface mount
- Furnished with spindle keeper, and 5 wood screws
- Chrome

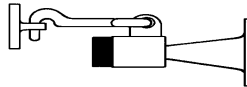

Item # M38287
U/M - Each

Replacement Bumpers for Door Stop :

- Designed to fit spring or cast steps
- Durable white plastic
- Deep cushion tip

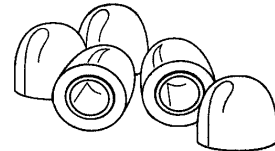

Item # M38307
U/M - Each

Plastic Wall Protectors :

- Protects and prevents walls from damage caused by door knob or lever handle locks
- Neutral white finish can be painted to match surface if desired
- Smooth finish

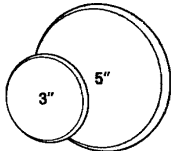

Item #	U/M	Diameter
M41226	Each	3"
M41229	Each	5"

Dome Door Stop :

- Polished and lacquered finish
- 1-3/4" overall diameter
- Concealed screw mount application
- High impact vinyl bumper
- Furnished with installation anchor and screw

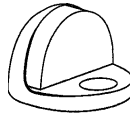

Item #	U/M	Finish
M38365	Each	Chrome
M38363	Each	Brass

Metal Door Silencer :

- Fits most metal door jams that are pre-punched with holes
- Shock absorbing virgin rubber
- Cone shape end easily installed
- Prevents door slams
- Neutral gray color

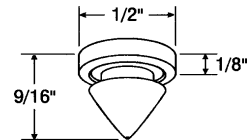

Item # M41232
U/M - Each

Replacement Door Holder Tip :

- Screw type with hole stops
- Furnished with screw

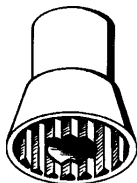

Item # M38341
U/M - Each

Drop Down Door Holder :

- 4-hole bracket
- Heavy duty die cast construction
- 5" drop arm
- Provides positive holding action
- Holds door open in any position
- Wedge foot effectively prevents door from closing
- Foot operated for easy use
- Non-marring, no-slip replaceable rubber foot
- Screws included

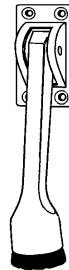

Item # M38286
U/M - Each

Drop Down Door Holder :

- 3 hole bracket
- Heavy duty die cast construction
- 4" overall size
- Provides positive holding action
- Holds door open in any position
- Wedge foot effectively prevents door from closing
- Non-marring, no-slip replaceable rubber foot
- Screws included

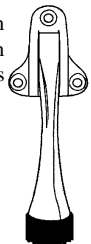

Item #	U/M	Finish
M38351	Each	Chrome
M38345	Each	Brass



MILL SUPPLY CO., INC.

Phone (410) 485-3343
Fax (410) 325-2240

Toll Free 1-800-817-8183

Hardware

Hardware

DOOR HARDWARE

Door Knocker :

- Polished brass
- Zinc die cast construction
- Surface mount application
- Weatherproof lacquered finish for outdoor use
- 3-1/4" wide x 6-1/4" long

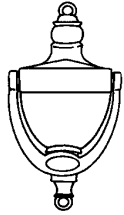

Item # M36060
U/M - Each

Door Knocker w/Viewer :

- Chrome plated finish
- 160 degree with plastic lens
- Overall size is 2-1/8" x 4-3/4"
- Fits all doors 1-3/8" - 2-1/4" thick
- 1/2" diameter viewer
- Surface mount application

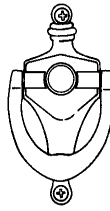

Item # M36084
U/M - Each

Door Knocker w/Viewer :

- Polished brass finish
- Zinc die cast construction
- 1/2" installation hole
- 1/2" diameter, 160 degree viewer with plastic lens
- Adjusts to doors 1-3/8" - 1-3/4"
- Overall dimensions 2" x 4"
- Surface mount application

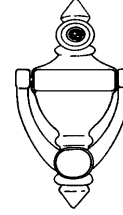

Item # M36067
U/M - Each

Door Knocker w/Viewer & Name Plate :

- Zinc die cast construction
- Polished brass finish
- 160 degree viewer with plastic lens
- Adjusts to 1-3/8" - 1-3/4" thick doors
- 2" x 5/8" name plate
- 1/2" diameter viewer
- Overall dimensions 2-1/8" x 4-3/4"
- Surface mount application



Item # M36086
U/M - Each

160 Degree Door Viewer :

- Solid brass construction
- 160 degree angle plastic lens
- Fits all doors 1-3/8" - 2-1/4" thick
- 1/2" installation hole

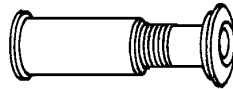

Item #	UM	Finish
M36017	Each	Brass
M36014	Each	Chrome

200 Degree Door Viewer :

- Solid brass construction
- Designed for easy viewing
- 200 degree angle plastic lens
- 3/4" installation hole
- Fits all doors 1-3/8" - 2-3/8"

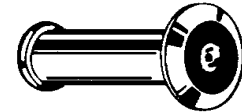

Item #	UM	Finish
M36025	Each	Brass
M36023	Each	Chrome

Black House #'s :

- Textured surface
- Each includes 2 brads
- 4" black finish

0 1 2 3 4 5 6 7 8 9

Item #	UM	#
M37070	Each	0
M37071	Each	1
M37072	Each	2
M37073	Each	3
M37074	Each	4
M37075	Each	5
M37076	Each	6
M37077	Each	7
M37078	Each	8
M37079	Each	9

Brass House #'s :

- Weatherproof
- Hand crafted
- High polished finish
- Anti-tarnish lacquer finish for outdoor use
- Furnished with solid brass screws
- 4" brass finish

0 1 2 3 4 5 6 7 8 9

Item #	UM	#
M37010	Each	0
M37011	Each	1
M37012	Each	2
M37013	Each	3
M37014	Each	4
M37015	Each	5
M37016	Each	6
M37017	Each	7
M37018	Each	8
M37019	Each	9



MILL SUPPLY CO., INC.

Phone (410) 485-3343
Fax (410) 325-2240

Toll Free 1-800-817-8183

Hardware

Hardware

DOOR HARDWARE

Chain Door Guard :

- Stamped steel construction
- Hardened steel chain
- Furnished with self tapping sheet metal screws

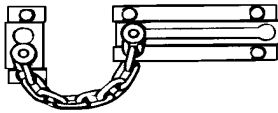

Item #	UM	Finish
M39664	Each	Brass
M39666	Each	Chrome

Storm Door Crash Chain :

- Single spring door chain with hold-up spring and nail
- Features high tensile plated steel spring & chain
- Hold-up spring prevents spring from rattling against glass
- Bright zinc plated finish
- Screws included

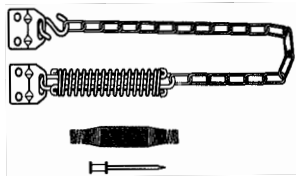

Item # M39668
U/M - Each

Door Bell :

- 2-1/2" bell
- 3-6 VDC
- 8-16 VAC low voltage

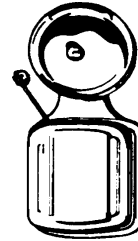

Item # M84015
U/M - Each

Door Chime :

NuTone®

- Easy to install
- No wiring
- Sounds two tones
- Includes gold anodized name plate with push button
- M39028, fits walls 1" to 3-3/4", thick white finish, has an optical lens viewer
- M39026, fits walls 1-1/4" to 2" thick, french white finish, has no optical lens viewer

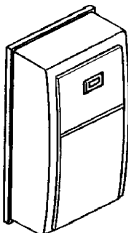

Item #	UM	Description
M39028	Each	With viewer
M39026	Each	No Viewer

Door Chime :

AuthChimes

- Easy to install
- No wiring
- Sounds two tones
- Model # 684
- 5" H x 2" W
- One-way viewing mirror
- Apartment identification plate
- Name plate

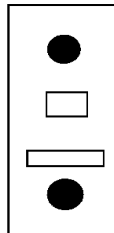

Item #	UM	Finish
M39005	Each	Silver
M39007	Each	Gold

Door Chime :

AuthChimes

- Easy to install
- No wiring
- Sounds two tones
- Model # 686
- 5" H x 2" W
- One-way wide angle viewing lens
- Apartment identification plate
- Name plate

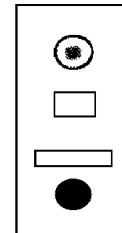

Item #	UM	Finish
M39009	Each	Silver
M39011	Each	Gold



MILL SUPPLY CO., INC.

Phone (410) 485-3343
Fax (410) 325-2240

Toll Free 1-800-817-8183

Hardware

Hardware

DOOR HARDWARE

Door Chime Grommet :

AuthChimes

- Replaces your damaged or missing grommet
- Sold by the each
- Fits Auth chimes

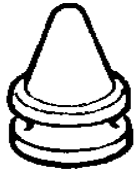

Item # M39003
U/M - Each

Push Button :

- For all chimes and bells to 16 volts
- No special wiring required
- Easy "do it yourself" installation
- Wood screws included
- Chrome finish



Item #	U/M	Description
M84018	Each	Lighted
M84021	Each	Unlighted

Push Button :

- 5/8" Insert / low voltage
- Weatherproof for indoor or outdoor use
- Unlighted

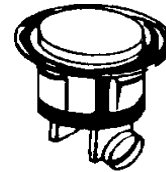

Item #	U/M	Finish
M84019	Each	Chrome
M84020	Each	Brass

Bell Wire :

- For all chimes and bells to 16 volts
- Easy to install
- 65 ft. to a spool

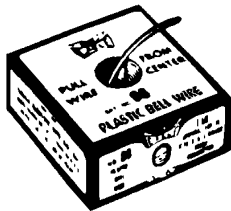

Item # M84016
U/M - Each

Transformer :



- For bells, buzzer, electric strikes
- 10 volt / 5va
- Hardwired transformers feature solid construction with heavy duty lead and ground wires
- UL and CSA approved

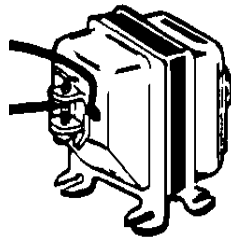

Item # M84024
U/M - Each

Apartment Speaker :

NuTone®

- White and gold speaker features a built-in buzzer, talk/listen switch and a volume control
- Speaker activates only when tenant operates talk/listen switch
- Installs easily in walls as thin as two inches
- Speaker-to-speaker wiring saves installation time
- Part of Nutone's Direct-A-Com 3 apartment security system

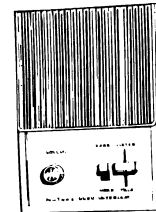

Item # M39061
U/M - Each



MILL SUPPLY CO., INC.

Phone (410) 485-3343
Fax (410) 325-2240

Toll Free 1-800-817-8183

Hardware

MAILBOXES / LETTER SLOTS

Auth Mailboxes :

- Vertical mailboxes
- USPS approved
- Designed for use in small multi-family apartment buildings
- Constructed of durable, heavy gauge extruded aluminum
- Door size - 16" H x 5-1/2" W
- Includes 5 pin cylinder locks with 2 keys each
- 6-3/4" wall depth for full recess mount
- When collar is added unit can be surface or semi-recess mounted.

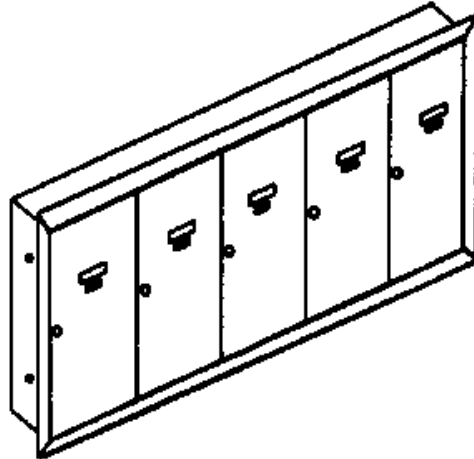

# of Boxes	Aluminum Finish		Gold Finish	
	Box #	Collar #	Box #	Collar #
3	M39118	M39122	M39120	M39124
4	M39126	M39133	M39128	M39135
5	M39137	M39145	M39139	M39147
6	M39149	M39165	M39151	M39167
7	M39169	M39173	M39171	M39177

Vertical Mailbox :

- All weather, heavy gauge plastic body
- Easy access & empty door that is lockable
- Top leading slot with weatherproof flap
- Black, 6" x 12-1/2"

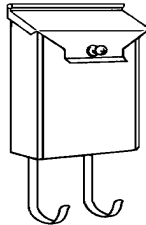

Item # M39107
U/M - Each

Horizontal Mailbox :

- All weather, heavy gauge plastic body
- Easy access & empty door that is lockable
- Top leading slot with weatherproof flap
- Black, 12" x 7-1/2"

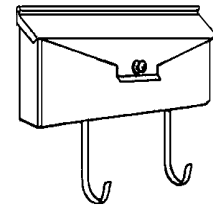

Item # M39111
U/M - Each

Letter Slot :

- Fits all wood and metal entrance doors
- Spring loaded flap opening
- Conforms to postal regulations
- Furnished with matching trim plate
- Overall size: 3" x 10"
- Opening size: 1-7/8" x 7-3/4"
- Double inside and outside flap
- Brass plated steel
- Brass finish



Item # M34472
U/M - Each



MILL SUPPLY CO., INC.

Phone (410) 485-3343
Fax (410) 325-2240

Toll Free 1-800-817-8183

Hardware

MAILBOX LOCKS

Auth-Florence Mailbox Lock :

- Fixed cam lock
- Replaces Auth Florence #C8715

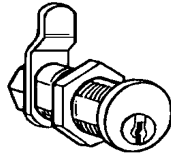

Item # M34401
U/M - Each

Bommer Mailbox Lock :

- Pin tumbler lock with removable cam
- Replaces Bommer #8710

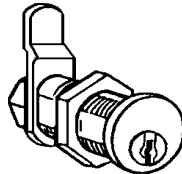

Item # M34439
U/M - Each

Bommer Mailbox Lock :

- Fixed cam lock
- Replaces Bommer #C8724

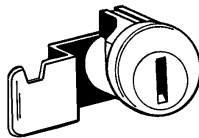

Item # M34430
U/M - Each

Cutler Mailbox Lock :

- Pin tumbler mailbox lock with removable cam
- Replaces Cutler #8718

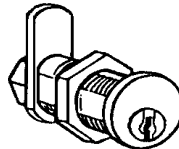

Item # M34441
U/M - Each

Auth-Florence Mailbox Lock :

- Fixed cam lock
- Replaces Auth Florence #C8713

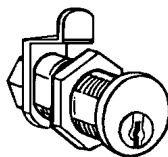

Item # M34413
U/M - Each

Miami-Carey Mailbox Lock :

- Fixed cam lock
- Replaces Miami-Carey #C8719

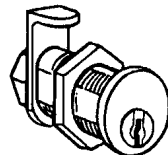

Item # M34416
U/M - Each

Bomer Mailbox Lock :

- Fixed cam lock
- Replaces Bommer #C8711

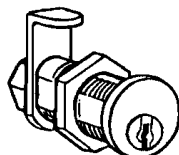

Item # M34421
U/M - Each



MILL SUPPLY CO., INC.

Phone (410) 485-3343
Fax (410) 325-2240

Toll Free 1-800-817-8183

Hardware

MAILBOX LOCKS

Mailbox Lock Deluxe :

- Replaces Auth, Eagle, United,
& Lori #1600

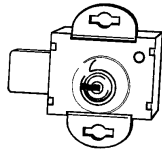

Item # M34403
U/M - Each

Lori Mailbox Lock :

- OEM Lori #1600

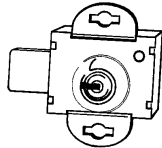

Item # M34433
U/M - Each

ILCO UNICAN

Mailbox Lock For Bommer :

- Replaces Bommer #25389

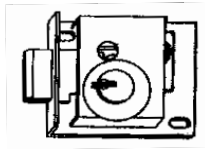

Item # M34407
U/M - Each

Bommer Mailbox Lock :

- OEM Bommer #25389

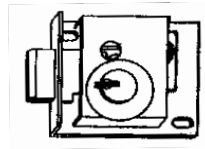

Item # M34424
U/M - Each

Mailbox Lock For American Device :

- Replaces American Device #C8714
- Fixed cam lock

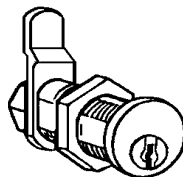

Item # M34419
U/M - Each

Mailbox Lock For Permabilt :

- Replaces Permabilt #XL201
- Fixed cam lock

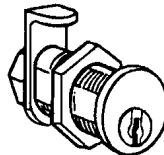

Item # M34444
U/M - Each

Fits Most Mailbox Lock :

- Disc tumbler mailbox lock w/5 cams
- Replaces American Device, Bommer,
Auth-Florence and Miami Carey
- Replacement keyblank #M34042

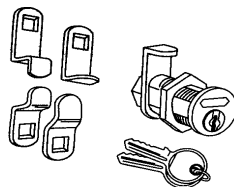

Item # M34427
U/M - Each



MILL SUPPLY CO., INC.

Phone (410) 485-3343
Fax (410) 325-2240

Toll Free 1-800-817-8183



Construction & Building Supplies

Construction & Building Supplies

DOW CORNING®



UGL®

Armstrong

OSI®
SEALANTS INC.



Red Devil®

POLYSEAMSEAL®



INSTANT Krazy®
GLUE

USG



3M



Bruce®

Congoleum®

PEMKO

Georgia-Pacific



MILL SUPPLY CO., INC.

Phone (410) 485-3343
Fax (410) 325-2240

Toll Free 1-800-817-8183

Construction & Building Supplies

CAULKS & SEALANTS

Tub & Tile Caulk :



- Latex compound fortified with silicone
- For tubs, showers and sinks, setting plastic metal and ceramic tile
- Waterproof and mildew resistant
- Long wearing - will not discolor
- Easy to use
- 6oz tube
- **White**



Item # M42280
U/M - Each

Case Qty.
12/ea

Tub & Tile Caulk :



- Bonds and seals
- Mildew resistant
- Flexible, paintable
- Water clean-up
- Excellent adhesion
- 5.5oz tube
- **White**



Item # M42139
U/M - Each

Case Qty.
12/ea

Tub & Tile Caulk :



- Bonds and seals
- Mildew resistant
- Flexible, paintable
- Water clean-up
- Excellent adhesion
- 5.5oz tube
- **Almond**



Item # M42147
U/M - Each

Case Qty.
12/ea

Tub & Tile Caulk :



- Bonds and seals
- Mildew resistant
- Flexible, paintable
- Water clean-up
- Excellent adhesion
- 10.1oz cartridge
- **White**



Item # M42143
U/M - Each

Case Qty.
12/ea

All purpose Adhesive Caulk :



- Excellent adhesion to wood, metal, ceramic, vinyl, porcelain, masonry and more
- Stays flexible
- Mildew resistant
- Soap and water cleanup
- Paintable
- Interior & exterior
- 4oz tube
- **White**



Item # M42127
U/M - Each

Case Qty.
35/ea

All purpose Adhesive Caulk :



- Excellent adhesion to wood, metal, ceramic, vinyl, porcelain, masonry and more
- Stays flexible
- Mildew resistant
- Soap and water cleanup
- Paintable
- Interior & exterior
- 10oz cartridge



Item #	U/M	Color
M42123	Each	White
M42119	Each	Clear
M42131	Each	Almond

Case Qty.
12/ea

Acrylic Latex Caulk :



- Latex sealant for general purpose interior and exterior applications
- Formulated with silicones for superior adhesion
- Mildew-resistant
- Will not yellow
- 10.5oz cartridge



Item #	U/M	Color
M42185	Each	Brown
M42189	Each	Bronze
M42193	Each	Ivory
M42201	Each	Almond
M42205	Each	White

Case Qty.
10/ea

Painter's Acrylic Latex Caulk :



- Multi-purpose caulk designed for the special needs of painters
- Exterior / interior use
- Adheres to wood, plaster, drywall, and masonry
- Paintable in 30 Min. with latex-based paints
- 10.1oz cartridge
- **White**



Item # M42155
U/M - Each

Case Qty.
10/ea

Acrylic Latex Caulk :



- Smooth easy to use latex formula for everyday, all-purpose household use
- Flows on easily, non-yellowing
- Good adhesion and paintability
- Inside and outside use, to fill cracks, openings and joints subject to low to moderate movement. Water clean up
- 10oz cartridge
- **White**



Item # M42271
U/M - Each

Case Qty.
12/ea



MILL SUPPLY CO., INC.

Phone (410) 485-3343
Fax (410) 325-2240

Toll Free 1-800-817-8183

Construction & Building Supplies

CAULKS & SEALANTS

Paintable Silicone Sealant :



- Lifetime durability guarantee
- 100% silicone rubber
- Excellent paintability & adhesion
- Non-offensive odor. Water clean-up
- Ideal for caulking and sealing: windows, door frames, siding, trim, skylights, gutters, vents and pipes
- 10.1oz cartridge
- **White**



Item # M42179
U/M - Each

Case Qty.
12/ea

Silicone Building & Glazing Sealant :

DOW CORNING®

- Conventional glazing sealant
- General construction applications
- Windshield and backlite replacement sealant
- One part sealant capable of +/- 25% joint movement
- 10.3oz cartridge

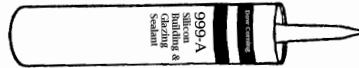

Item #	U/M	Color
M42110	Each	White
M42107	Each	Clear

Case Qty.
12/ea

Contractors Silicone Sealant :



- Designed for contractors
- For general glazing : glass, plastic, channel or stop
- For general sealing : sheet metal, skylights, ventilators, a/c, metal / plastic signs, glass block structures, bedding of marine hardware
- 10.1oz cartridge



Item #	U/M	Color
M42239	Each	Clear
M42231	Each	White

Case Qty.
24/ea

General Purpose Silicone :



- 100% silicone
- Provides excellent adhesion and strong weather-resistant seals to most non-porous surfaces indoors or outdoors
- Resists cracking, shrinking or peeling and provides excellent weatherproof, watertight seal against air and moisture
- 10.1oz cartridge



Item #	U/M	Color
M42177	Each	White
M42176	Each	Clear

Case Qty.
12/ea

Roof Cement :



- For cementing and waterproofing chimney, dormer, flashing, valley joints and all types of roof seams
- Remains pliable and resilient for years
- Contains no asbestos, coal tar, or other adulterants
- May be used on wet and dry surfaces
- 10.5oz cartridge
- **Black**



Item # M44242
U/M - Each

Case Qty.
10/ea

Concrete Sealant :



- Fills and seals cracks in concrete and masonry
- Contains silicone for improved adhesion and water resistance
- Repairs cracks in steps, driveways, sidewalks, mortar joints, and similar surfaces
- 10.3oz cartridge
- **Grey**



Item # M42409
U/M - Each

Case Qty.
12/ea

Driveway Crack Filler :



- Special acrylic formulation fortified with silicone
- Use on asphalt surfaces - easy to gun
- Excellent adhesion even to damp surfaces
- May be subjected to traffic two hours after application
- 10.5oz cartridge
- **Black**



Item # M42417
U/M - Each

Case Qty.
10/ea

Expanding Foam :



- Interior / exterior
- Triple-expanding foam seals gaps, bonds, and insulates
- Large and small holes
- Formaldehyde free
- Makes up to 5 gallon.
- Contains fire retardant
- Equals as much as 20 times of caulk
- Trigger / hose dispenser
- 12oz can



Item # M42418
U/M - Each

Case Qty.
12/ea

Epoxy Putty :

- Hardens like steel in 20 minutes
- Can be drilled, filed, tapped, sanded and machined after 1 hour of curing
- Can be painted as soon as applied
- For sink traps, oil and water tanks, pipe joints, drain leaks, cracked wall and floor tile, small dent repairs, fuel tanks, radiators, concrete swimming pools, fish tanks, etc
- Knock off what you need, store the rest in tube



Item # M99971
U/M - Each



MILL SUPPLY CO., INC.

Phone (410) 485-3343
Fax (410) 325-2240

Toll Free 1-800-817-8183

Construction & Building Supplies

ADHESIVES

Panel & Construction Adhesive :



- Excellent for paneling, drywall, hardboard / inboard wood
- Provides a secure, permanent bond
- Minimizes nailing and unsightly "nail popping"
- Waterproof and weatherproof



Item #	U/M	Size
M42304	Each	10.5oz
M42305	Each	29oz

Case Qty. 12/ea

Krazy Glue :



- All purpose
- Forms a strong, long - lasting bond on most surfaces
- Excellent for: ceramic, wood, plastic, rubber, metal and glass
- Stay fresh container
- One drop applicator
- .07oz container



Item # M42569
U/M - Each

Super Fast Epoxy :

- Setting time 5 minutes
- 2 part epoxy
- Easy to use dispenser
- Bonds to wood, metal, glass, china, concrete, tile, brick and most hard plastics
- Curing time 24 hours
- Bond strength up to 1,500 lbs. psi.
- 1oz container



Item # M42683
U/M - Each

Wood Glue :



- Specially formulated for wood gluing
- Grabs fast but allows for repositioning, reduces clamping time
- Penetrates wood deeply for strong bond
- Can be painted and stained
- Will not gum up from heat



Item #	U/M	Size
M42563	Each	4oz
M42564	Each	8oz
M42565	Each	16oz
M42568	Each	Gallon

All Purpose Glue :



- Pure white ready to use adhesive
- Fast drying with a transparent bond
- Unmatched for general gluing of wood, paper, pottery, leather, cloth and other porous materials where waterproof joints aren't essential
- 4oz container



Item # M42552
U/M - Each

Contact Cement :



- Non-flammable, solvent type adhesive
- Use to install formica, linoleum and tile
- Bonds on contact
- Waterproof and heat resistant
- Use on metal, china, wood, masonry or leather
- 3oz bottle contains applicator brush



Item #	U/M	Size
M44041	Each	3oz
M44044	Each	Pint
M44046	Each	Quart
M44047	Each	Gallon

Spray Adhesive :



- Multipurpose adhesive
- Bonds many foils, plastics, papers, foams, metals and cardboards
- Low mist formula
- Fast, aggressive tack - immediate grab lets you assemble parts faster
- Almost double the coverage than most competitive brands
- 16-1/2oz can



Item # M42570
U/M - Each

Case Qty. 12/ea

Cove Base Adhesive :

- White acrylic cove base adhesive formulated for the installation of rubber and vinyl cove base over wood, concrete, brick, plaster, wallboard or other porous surfaces
- Fast drying
- Low odor
- Non-staining
- Low V.O.C.'s
- 1 gallon container



Item # M43206
U/M - Each

Vinyl Floor Tile Adhesive :



- For installing Armstrong residential and commercial felt-back sheet flooring and linoleum
- Fast grab - prevents edge curl
- Excellent bond integrity
- Moisture and alkali resistant
- Solvent free
- 1 gallon container



Item # M43176
U/M - Each



MILL SUPPLY CO., INC.

Phone (410) 485-3343
Fax (410) 325-2240

Toll Free 1-800-817-8183

Construction & Building Supplies

ADHESIVES / PATCHES & FILLERS

Ceramic Tile

Adhesive :

- Type I multi-purpose ceramic floor and wall tile adhesive
- Nonflammable
- For use with approved concrete, gypsum, wallboard and exterior douglas fir plywood
- No mixing required
- Meets ANSI A136.1, Type I requirements



Item #	U/M	Size
M43186	Each	1gal
M43188	Each	3.5gal

Vinyl Floor Tile

Adhesive :

- Clear set and solvent free adhesive made for the installation of asphalt and vinyl composition tile on floors of concrete, plywood, hardboard or association grade particle board
- Not recommended in areas of excessive alkali, moisture or hydrostatic pressure



Item #	U/M	Size
M43178	Each	1 gal
M43182	Each	4 gal

Water Putty :

- Meets thousand repair needs
- Just add water and use
- Hardens in aprox. 1 hour
- Fills cracks - knot, nail, and screw holes
- Permanently adheres in wood, cement, plaster, tiles, composition and stone
- Hundreds of uses
- 4 lb container

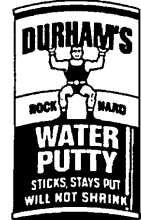

Item # M42697
U/M - Each

Cellulose Fibre

Filler :

- Sticks to metals, wood, glass and stone
- High performance wood fibre that hardens on exposure to air, giving a surface body that looks and acts like wood
- Can be sanded, cut, drilled, planed, whittled, stained, varnished, painted or laquered
- Resists water and grease
- Natural - color
- 4oz container



Item # M42699
U/M - Each

Easy Sand

Joint Compound :

- Ideal for drywall finishing and patching drywall and plaster surfaces
- Weighs up to 25% less than conventional setting powder compounds for easier handling
- Sands similar to ready-mixed, all purpose compounds for faster, smoother finishing
- Resists shrinkage & cracking
- 18 lb. bag

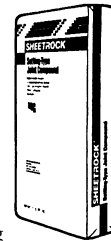

Item #	U/M	Set Up Time	Working Time
M42007	Each	20-30 min	15 min
M42010	Each	30-80 min	20 min

Wall Repair Patch :

- Metal reinforced patch for repairing holes in drywall or plaster walls and ceilings
- Self adhesive for easy application
- Lightly sand edges, center patch over hole, and press on
- Cover with spackle, sand and paint



Item #	U/M	Size
M10154	Each	4" x 4"
M10158	Each	6" x 6"
M10160	Each	8" x 8"

Lightweight

Joint Compound :

- Ready mixed / Non-asbestos
- More forgiving than other joint compounds for embedding joint tape and for filling and finishing gypsum panel joints, corner bead, trim and fasteners
- Also for skim coating and for applying simple textures
- Reclosable plastic lid
- 44lbs
- 4.5 gallon bucket

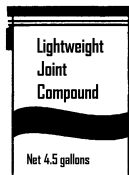

Item # M42005
U/M - Each

Joint Compound :

- Ready mixed / Non-asbestos
- For covering fasteners and corner beads
- Repairs cracks in interior plastic, gypsum, and masonry that has not been subject to moisture
- Resealable plastic lid
- 62lbs
- 5 gallon bucket

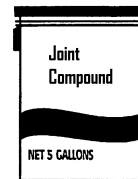

Item # M42003
U/M - Each



MILL SUPPLY CO., INC.

Phone (410) 485-3343
Fax (410) 325-2240

Toll Free 1-800-817-8183

Construction & Building Supplies

PATCHES & FILLERS

Spackling Paste :



- All purpose, ready to use spackling compound
- Interior or exterior use for patching cracked plaster, filling nail holes, smoothing surface imperfections on unprimed wood
- May be painted
- Sands easily
- 1qt container



Item # M44020
U/M - Each

Lightweight Spackling :



- Lightweight premixed formula fills cracks, nailheads, and all size holes in just a single application
- Use on plaster, wallboard, wood and stucco
- Eliminates the need for secondary patching
- Can be used indoors or outdoors
- No sanding required



Item #	U/M	Size
M44028	Each	1 quart
M44029	Each	1 gallon

Plaster Of Paris :



- Used to patch and repair large holes in interior plaster or wallboard
- Ideal for hobby molding and casting
- Dries to a smooth, hazy snow-white finish that is easily sanded
- Sets in approximately 30 minutes
- Mixes with water
- 3lb container



Item # M44031
U/M - Each

Plaster Patch :



- Pure white, slow set, glue base marble patching plaster
- Easily troweled to a feather edge
- Plasticity prevents crumbling and rolling under trowel
- Setting time 1 - 1-1/2 hours in mixing receptacle
- Asbestos free
- Mixes with water
- 2-1/2lb box



Item # M44066
U/M - Each

Pre-mix Tile Grout :



- Water-resistant compound grouts all ceramic and mosaic tile
- Formulated with premium acrylic latex for fast, easy-to-use application
- 1qt container



Item # M44130
U/M - Each

Powder Grout :



- Mixes easily with water and dries hard and white
- Excellent for repairing and restoring ceramic and mosaic tile
- Use to fill cracks and breaks around bathtubs, sinks and towel racks
- Contains no asbestos
- 5lb box

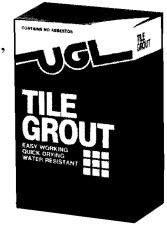

Item # M44128
U/M - Each

Floor & Wall Tile Grout :

- Sanded
- For grout joints 1/8" to 5/8"
- Interior / exterior use
- For grouting slate, granite and most types of ceramic, porcelain and quarry tiles
- Mixes with water
- Polymer modified
- 25lb bag

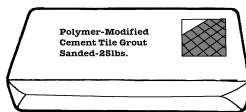

Item #	U/M	Color
M44115	Each	Grey
M44121	Each	White

Wall Tile Grout :

- Unsanded
- For grout joints 1/16" to 1/8"
- Use only for interior grouting of non vitrious ceramic wall tiles
- Polymer modified
- Mixes with water
- White
- 25lb bag

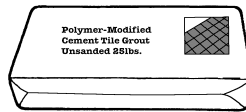

Item # M44118
U/M - Each

Glazing Compound :



- Cures quickly while remaining flexible
- Superior adhesion
- Quality formula for all glass installation applications
- Won't stain
- Paintable



Item #	U/M	Size
M44093	Each	Pint
M44095	Each	Quart



MILL SUPPLY CO., INC.

Phone (410) 485-3343
Fax (410) 325-2240

Toll Free 1-800-817-8183

Construction & Building Supplies

Construction & Building Supplies

LEVELERS & CONCRETE REPAIR

Concrete Protector :



- Provides a clear, protective coating for new or old masonry
- Use in basements, driveways, sidewalks, garages or patios
- Can be used as a sealer, primer or hardener
- Coverage approx. 400 square feet
- Retards concrete spalling caused by salt application during winter months
- 1 gallon container

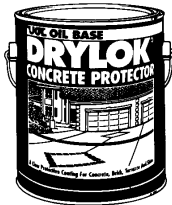

Item # M44076
U/M - Each

Leveler Patch :



- A highly adhesive, multi-purpose repair compound for leveling floors and repairing wood, stone, concrete and plaster
- Excellent for setting bathroom fixtures and casting patterns
- For filling nail holes, knot holes in wood and cracks in plaster
- Easily mixed with water
- Contains no asbestos
- 25lb bucket



Item # M44069
U/M - Each

Leveling Patch :

- Quick setting, nonshrinking dry powder which when mixed with water, provides a fast drying material for patching uneven suspended floors prior to installation of all types of hard and soft surface flooring materials
- Fills in low spots, holes and cracks
- Coverage approx. 33.3 square ft. at 1/8" thick
- 10lb bag



Item # M44148
U/M - Each

Hydraulic Cement :



- Sets in 3-5 minutes
- Ideal for anchoring machinery, iron railings, hooks and eye bolts
- Reduces radon gas penetration
- Stops water leaks through cracks in masonry
- Excellent for sealing floor and wall joints
- Mixes with water
- Instantly stops running water, even under pressure
- 10lb can



Item # M44065
U/M - Each

Anchoring Cement :

- Sets in 15-20 minutes
- 5,090 psi compression strength after only 60 minutes.
- Controlled expansion, only .003" per linear inch which mechanically locks bolts in place. Excellent for grouting
- Mixes with water
- Use for anchoring, bolts, dowels, railings, machinery, ceramic fixtures, reinforcing rods
- 50lb bucket

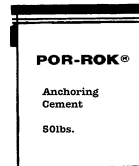

Item # M44146
U/M - Each

Concrete Resurfacer :

- Used for resurfacing broken or chipped concrete
- Leaves a bright, new finish
- Bonds stronger than regular cement mixes
- May also be used as a brush-coat application
- Easy to use
- Mixes with water
- 40lb bag

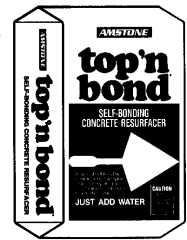

Item # M44143
U/M - Each

Concrete Mix :

- A mixture of Portland cement, washed and graded sand, and gravel
- For repair and building jobs where concrete thickness exceeds 2"
- Ideal for pouring footings, anchoring poles and posts, and building walks, drives, curbs and steps
- Exceeds ASTM Spec. C 387
- 4000 psi average compressive strength
- 80lb bag



Item # M44133
U/M - Each

Sand Mix :

- A blend of Portland cement and washed sand
- Designed for repair and building jobs of less than 2" in thickness
- Can be used for patching steps, sidewalks and floors
- Can be used for topping over existing concrete or as a grout for drain tile
- Exceeds ASTM Spec. C 387
- 5000 psi average compressive strength
- 80lb bag



Item # M44138
U/M - Each

Mortar Mix :

- A mixture of masonry mortar cement and graded bank sand
- Especially designed for laying brick, block or stone
- Can be used to repair masonry or used as stucco
- Exceeds ASTM Spec. C 387
- 1000 psi average compressive strength
- 80lb bag



Item # M44135
U/M - Each

Cement Finishing Tools
Page 72 & 73



MILL SUPPLY CO., INC.

Phone (410) 485-3343
Fax (410) 325-2240

Toll Free 1-800-817-8183

Construction & Building Supplies

BLACKTOP / SAND / ROOF REPAIR

Blacktop Mix :

- A blend of steam cured asphalt and graded aggregates
- Can be used to build or repair any blacktop area
- Just place material over desired area and tamp firmly into place
- Specifically designed for pothole applications
- 60lb bag



Item # M44139
U/M - Each

High Performance Blacktop Mix :

- Special additives produce a premium product that remains soft and pliable in sub-freezing weather, bonds equally well in wet and dry conditions, and requires less work than conventional asphalt patching materials
- Can be driven on immediately after repair
- 60lb bag

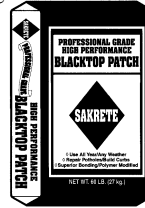

Item # M44144
U/M - Each

All Purpose Sand :

- A uniformly graded and sterilized sand
- Perfect for use as a soil conditioner, traction material on icy walks, as an absorbent in greasy areas and in pet boxes
- 60lb bag

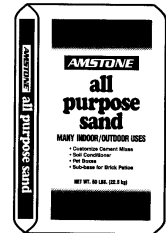

Item # M44141
U/M - Each

Natural Play Sand :

- A finely graded limestone that is sterilized for use in children's sand boxes
- Other uses include soil conditioning, traction on ice, and as an absorbent
- 60lb bag



Item # M44140
U/M - Each

Please Note

- 11oz Tubes of :
- Roof Cement
 - Driveway Crack Filler
 - Concrete Sealer.

Pages (151 & 152)

Plastic Roof Cement :

- A fabricated asphalt cement for repairing holes and cracks in roofing
- Also repairs rust spots and joints in leaky gutters, water tanks and corrugated sheeting
- Repair pointing around chimneys, troughs, copings and adhering loose shingles
- 5gal pail



Item # M44238
U/M - Each

Roof Coating :

- Recommended for sealing and rejuvenating of build-up and old composition roofs
- Restores protective properties destroyed by exposure
- Protects against deterioration due to exposure, ensuring greater roof surface
- Can be used on metal roofs and concrete decks
- 5gal pail



Item # M44239
U/M - Each

Roof Felt :

- 15lb residential felt
- Applied to roof before shingles
- Provides a moisture barrier between plywood and shingles
- 144' x 36" wide
- Rolls easily onto roof
- 45lb roll



Item # M44216
U/M - Each

Aluminum Flashing :

- .010 gauge
- Applied around chimneys, under easements, soffit vents and for general purpose repair
- 50' x 14" wide

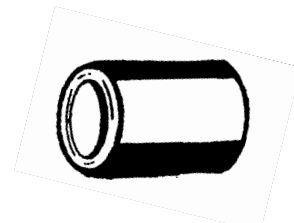

Item # M44202
U/M - Each

Metal Snips
Page 67 &
68



MILL SUPPLY CO., INC.

Phone (410) 485-3343
Fax (410) 325-2240

Toll Free 1-800-817-8183

Construction & Building Supplies

ROOF DRAINAGE

Downspout Strap :

- Made of aluminum
- Replaces old or damaged downspout straps
- Universal straps fit both 2" x 3" and 3" x 4" applications

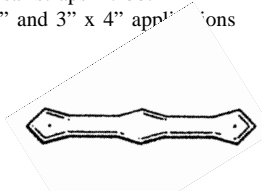

Item #	U/M	Color
M40627	Each	White
M40626	Each	Brown

Gutter Spikes :

- Galvanized spike 7"
- Used to attach rain gutter
- Head end is painted white to match exterior surface

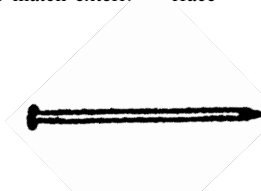

Item # M40649
U/M - Each

Downspout Adapter :

- Diverts water from downspout into drainage pipe
- Made of PVC
- White

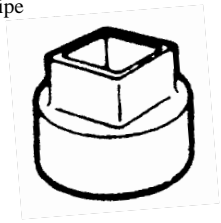

Item #	U/M	D/S	Size	Pipe Size
M40672	Each	2"x3"	3"	3"
M40673	Each	2"x3"	4"	4"
M40674	Each	3"x4"	4"	4"

"A" Elbows :

- Replaces old or damaged elbows
- 19 gauge aluminum is thicker than most economy downspouts to ensure longer life

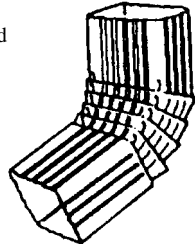

Item #	U/M	Color	Size
M40632	Each	White	2"x3"
M40641	Each	White	3"x4"
M40629	Each	Brown	2"x3"
M40639	Each	Brown	3"x4"

"B" Elbows :

- Replaces old elbows
- 19 gauge aluminum is thicker than most economy downspouts to ensure longer life

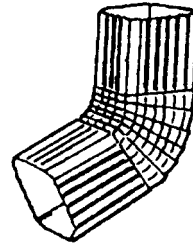

Item #	U/M	Color	Size
M40638	Each	White	2"x3"
M40642	Each	White	3"x4"
M40635	Each	Brown	2"x3"
M40640	Each	Brown	3"x4"

Down Spout :

- Replaces old or damaged down spouts
- 19 gauge aluminum is thicker than most economy down spouts to ensure longer life
- 10' long

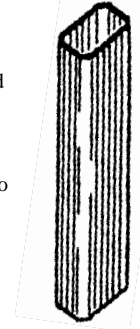

Item #	U/M	Color	Size
M40655	Each	White	2"x3"
M40657	Each	White	3"x4"
M40656	Each	Brown	2"x3"
M40658	Each	Brown	3"x4"

Downspout Extension :

- Fits 2"x3" or 3"x4" downspouts
- Each interlocking section extends up to 55"
- Controlled drainage
- Diverts water away from foundation
- Diverts water around trees, shrubs and decks
- Made of high density plastic
- Can be trimmed to fit (as pictured)
- Green

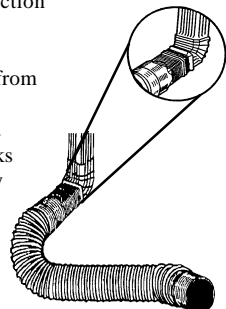

Item # M40651
U/M - Each

Splash Block :

- 30" length
- Made of heavy duty plastic
- Green
- Diverts water away from residence

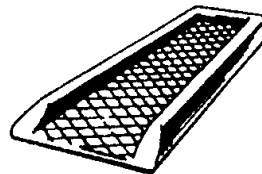

Item # M40613
U/M - Each

Splash Block :

- 30" length
- Made of high strength concrete
- Grey
- Diverts water away from residence

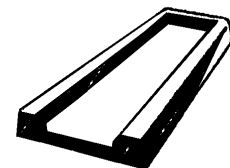

Item # M40607
U/M - Each



MILL SUPPLY CO., INC.

Phone (410) 485-3343
Fax (410) 325-2240

Toll Free 1-800-817-8183

Construction & Building Supplies

WEATHER STRIP

Foam Weather Strip :

- Wide gap foam weather strip
- Instant installation
- Self adhesive- just peel and press
- Closed cell vinyl foam fills larger gaps
- Resists moisture extremely well
- Great for sealing air conditioners or loose fitting doors
- Grey



Air Conditioner Foam Seal :

- 1-1/4" thick
- 1-1/4" wide
- 42" long
- Great for sealing window air conditioners
- Keeps in cool air during summer months
- Poly foam cushions and dampens vibrations
- Removable and reusable
- Grey

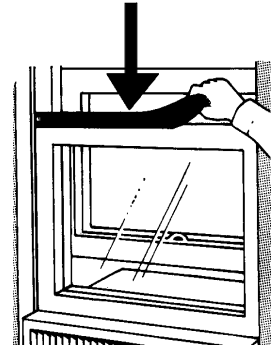

Item #	U/M	Thickness	Width	Length
M41704	Each	1/8"	1/4"	17'
M41708	Each	3/16"	3/8"	17'
M41712	Each	1/4"	3/8"	17'
M41716	Each	3/8"	1/2"	10'
M41720	Each	3/8"	3/4"	10'
M41728	Each	1/2"	3/4"	10'

Item # M41766
U/M - Each

Magnetic & Compression Door Set :

- Made specifically for metal doors
- Kerf fit
- Seals completely against drafts and moisture
- PVC material self-adjusts to uneven surfaces
- Fits up to 36" door
- No tools required
- Includes; 2ea 7' pieces and 1ea 3' piece
- White

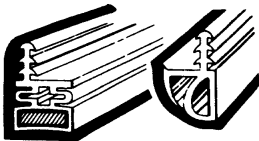

Item # M41755
U/M - Each

Wood & Foam Weather Strip Door Set :

- Closed cell foam
- Foam compresses against door for a tight seal
- Weatherproof and water resistant
- Wood can be painted to match door color
- Fits all doors up to 36"
- Nails included
- Includes; 2ea 7' pieces and 1ea 3' piece

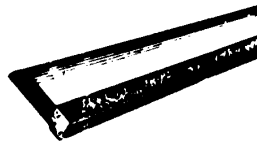

Item # M41528
U/M - Each

Aluminum & Vinyl Weather Strip Door Set :

- Seals against air, dust, water and sound
- Screws included
- Slotted holes for easy adjustment
- Includes; 2ea 7' pieces and 1ea 3' piece

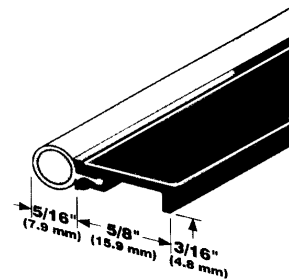

Item # M41527
U/M - Each



MILL SUPPLY CO., INC.

Phone (410) 485-3343
Fax (410) 325-2240

Toll Free 1-800-817-8183

Construction & Building Supplies

SWEEPS / DOOR BOTTOMS & THRESHOLDS

Door Bottom Sweep :

- Fills up to 1" gaps
- Seals against air, dust, water and sound
- Most effective when mounted to outside of outswing door
- Screws included
- Slotted holes for easy adjustment
- 36" long
- Mill finish aluminum with vinyl seal

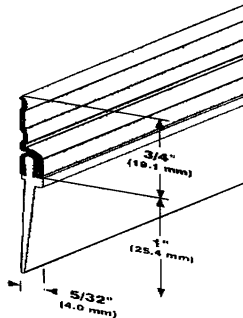

Item # M41533
U/M - Each

Door Bottom Sweep :

- Fills up to 1-1/2" gaps
- Seals against air, dust, water and sound
- Most effective when mounted to outside of outswing door
- Screws included
- Slotted holes for easy adjustment
- 36" long
- Mill finish aluminum with vinyl seal
- Heavy-duty

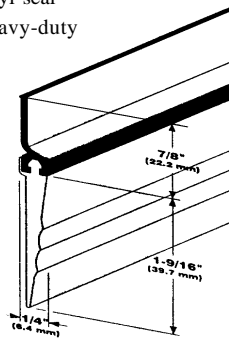

Item # M41530
U/M - Each

Self-Adhesive

Door Bottom Sweep :

- Just peel and stick
- Fits all doors up to 36"
- Seals gaps up to 1/2"
- White
- 1-1/2" x 36"
- For both metal and wood doors



Item # M41513
U/M - Each

Door Bottom Shoe with Rain Drip :

- 3/8" to 1/2" clearance required between bottom of door and top of threshold
- Seals against air, dust, water and sound
- Screws included
- Slotted holes for easy adjustment
- 36" long
- Mill finish aluminum with vinyl seal

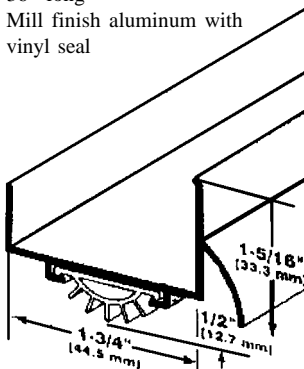

Item # M41512
U/M - Each

Combination Door Shoe & Kick Plate :

- Seals against air, dust, water and sound
- Screws included
- Slotted holes for easy adjustment
- 36" long
- Mill finish aluminum with vinyl seal

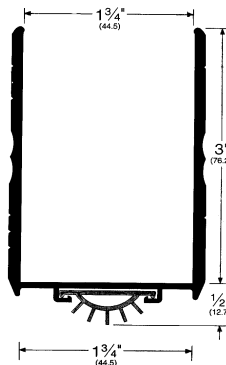

Item # M41524
U/M - Each

Marble Threshold :

- Attractive white color
- 4" wide
- 5/8" thick
- Replaces damaged or old threshold



Item #	U/M	Length
M43353	Each	24"
M43356	Each	28"
M43359	Each	30"
M43368	Each	36"



MILL SUPPLY CO., INC.

Phone (410) 485-3343
Fax (410) 325-2240

Toll Free 1-800-817-8183

Construction & Building Supplies

THRESHOLDS

Vinyl Top Threshold :



- 3-1/2" wide
- 36" long
- Used to seal gap at bottom of door
- Vinyl-top creates a seal at the bottom of the door, eliminating the need for door sweeps or door shoes
- Fills gaps up to 3/4"
- Seals against air, dust, water and sound
- Screws, vinyl seal and vinyl feet included
- Mill finish aluminum with seal and vinyl feet

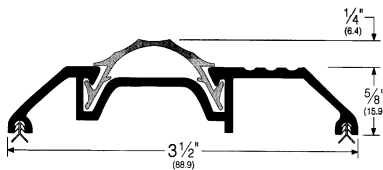

Item # M41506
U/M - Each

Vinyl Top Threshold :

- 3-1/4" wide
- 36" long
- Used to seal gap at bottom of door
- Vinyl-top creates a seal at the bottom of the door, eliminating the need for door sweeps or door shoes
- Fills gaps up to 3/4"
- Seals against air, dust, water and sound
- Screws, vinyl seal and vinyl feet included
- Mill finish aluminum with seal and vinyl feet

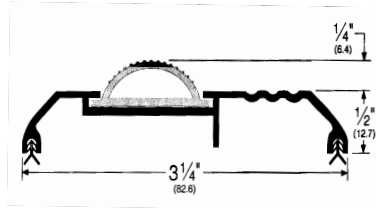

Item # M41509
U/M - Each

Threshold :



- 5/8" high
- 3-1/2" wide
- 36" long
- Use with a door bottom or door sweep
- Seals against air, dust, water and sound
- Screws and vinyl feet included
- Mill finish aluminum with vinyl feet

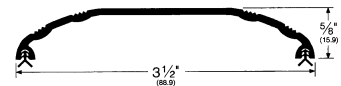

Item # M41515
U/M - Each

Threshold :



- 1" high
- 4" wide
- 36" long
- Use with a door bottom or door sweep
- Seals against air, dust, water and sound
- Screws and vinyl feet included
- Mill finish aluminum with vinyl feet

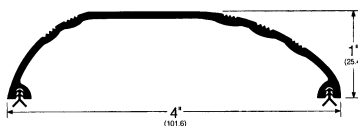

Item # M41521
U/M - Each

Threshold & Bottom Shoe w/Rain Drip Set :



- 2 piece set includes both threshold and bottom shoe
- For 1-3/4" door
- Threshold is 5/8" high, 3-1/2" wide and 36" long
- Bottom shoe is 36" long
- Seals against air, dust, water and sound
- Set includes all screws, vinyl seals and feet
- Slotted holes for easy adjustment
- Mill finish aluminum with vinyl seal and feet

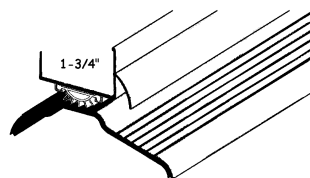

Item # M41518
U/M - Each

Handicapped Threshold :

- Meets requirements of: ADAAG-1992, CABO/ANSI A117.1-1992, and title 24, CAC Sec 2-3303(i)
- Sound tested to: ASTM E 90-90 and ASTM E 1408-91
- Smoke tested to UL 1784-1990
- Meets: NFPA-105-1993
- 1/2" high by 4" wide
- Screws included
- 36" wide
- Mill finish aluminum

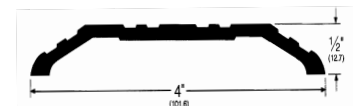

Item # M41511
U/M - Each



MILL SUPPLY CO., INC.

Phone (410) 485-3343
Fax (410) 325-2240

Toll Free 1-800-817-8183

Construction & Building Supplies

MISC. BUILDING PRODUCTS

Polyethylene :

- Plastic sheeting uses: equipment covering, vapor barrier, insulation, paint protection and moisture barrier

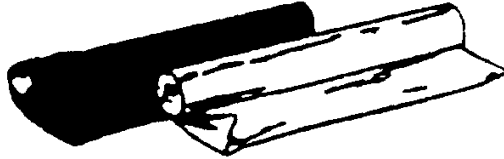

Item #	U/M	Color	Size	Mil
M44378	Roll	Clear	10'x100'	4
M44380	Roll	Clear	20'x100'	4
M44386	Roll	Clear	10'x100'	6
M44388	Roll	Clear	20'x100'	6
M44390	Roll	Black	20'x100'	6

Perimeter & Safety Fence :

- Both are highly visible safety orange in color
- Perimeter fence is lightweight and easy to work with
- Safety fence is reinforced with metal for superior durability

Perimeter Fence

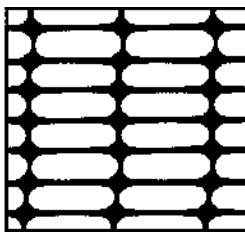

Safety Fence

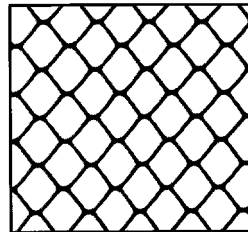

Item #	U/M	Style	Size
M44398	Roll	Perimeter	4'x100'
M44399	Roll	Safety	4'x50'

Polyethylene Carpet Protector :

- For temporary use on carpets
- Protects from dirt and spills
- Removes easily without residue
- Excellent for high traffic areas
- Designed for model homes and model rental units
- Self-adhering



Item #	U/M	Color	Size
M44213	Roll	Clear	24'x200'
M44214	Roll	Clear	36'x500'

Silt Fence :

- Silt fence is specifically designed to reduce soil sediment run off from, or into, protected areas
- Water is allowed to filter through the fabric while suspended soil particles settle to the ground
- Restricts the loss of costly soil from the site while permitting the water to drain efficiently
- With stakes
- 36'x100'

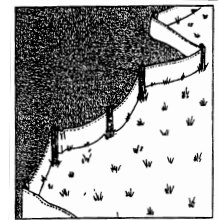

Item # M44394
U/M - Roll

Safety Rail :

- Powdered coated white aluminum patio door safety rail
- Available in 3,4 & 6' lengths



Item #	U/M	Length
M45011	Each	3'
M45019	Each	5'
M45026	Each	6'



MILL SUPPLY CO., INC.

Phone (410) 485-3343
Fax (410) 325-2240

Toll Free 1-800-817-8183

Construction & Building Supplies

MISC. BUILDING PRODUCTS

Carpet Bar :

- Used between carpeted and flat finished floor
- Hammered finish
- Pre-drilled holes for easy installation
- Sold in 12' lengths only

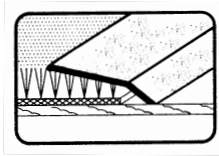

Item #	U/M	Size	Color
M43305	Each	12'x1-1/2"	Silver
M43301	Each	12'x1-1/2"	Gold
M43307	Each	12'x2"	Silver
M43304	Each	12'x2"	Gold

Carpet Bar

Screw Nails :

- Used for tacking down carpet bars
- Sold per box only
- Approx. 400 screw nails per box
- Rounded heads for smooth finish



Item #	U/M	Color
M43283	Box	Silver
M43286	Box	Gold

Cove Base :

- .080" thick, 4" wide
- Toe edge
- Replaces old or damaged cove base
- Installs with adhesive (not shown)

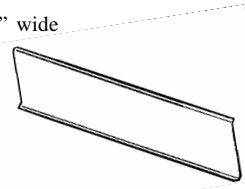

Item #	U/M	Contains:	Color
M43226	Box	30ea / 4' Pieces	Almond
M43235	Carton	1ea / 120' Roll	Almond
M43231	Box	30ea / 4' Pieces	White
M43241	Carton	1ea / 120' Roll	White
M43229	Box	30ea / 4' Pieces	Black
M43239	Carton	1ea / 120' Roll	Black

Walk Off Mat :

- 3'x5' 12oz fiber
- 100% continuous filament olefin bonded to a stain, and slip-resistant base
- Indoor and outdoor use

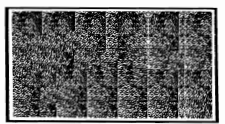

Item #	U/M	Color
M44801	Each	Brown
M44806	Each	Grey

Builder's Shims :

- Cedar shingles grade D
- Used for shimming doors and windows or replacing damaged cedar shingles
- Sold per bundle
- 20sf per bundle



Item # M40676
U/M - Each

Rosin Paper :

- Used to cover and protect floors in new construction homes
- Can be used to cover almost anything before painting
- 3'x144' rolls
- Will not bleed when wet
- 432 square feet per roll



Item # M44211
U/M - Roll

Ceiling Tile Light Panel :

- Clear replacement panel for light fixture
- Cracked ice surface finish
- 23-11/16" x 47-11/16"

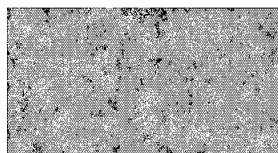

Item # M40935
U/M - Each

Case Qty.
20/ea

Ceiling Tile :

- 2' x 4' x 5/8" panels
- Suspended ceiling panels
- Easy to cut, lightweight
- Clean with water
- White #345
- 8 panels per case, 64 square feet



Item # M40943
U/M - Case

Access Panel :

- Plastic panel used to conceal plumbing, electrical and wiring
- Provides easy access
- Cover snaps into frame
- Can be installed in wall or ceiling
- White



Item #	U/M	Size
M40005	Each	6"x9"
M40002	Each	14"x14"



MILL SUPPLY CO., INC.

Phone (410) 485-3343
Fax (410) 325-2240

Toll Free 1-800-817-8183

Construction & Building Supplies

CERAMIC WALL TILES

* Many other colors of ceramic wall tiles are available that are not pictured in this catalog. (Contact your sales representative for more information).

#1 Outside Corner :

- White
- 2"x2"
- Sold per each
Item # M44738
U/M - Each

#2 Bullnose Cap :

- White
- 2"x6"
- Sold per each
Item # M44714
U/M - Each

#3 Bullnose Corner Cove Base :

- White
- 4"x6"
- Sold per each
Item # M44753
U/M - Each

#5 Square :

- White
- 4-1/4"x4-1/4"
- Sold per case, 12sf per case
Item # M44526
U/M - Case

#6 Cove Base :

- White
- 4"x6"
- Sold per each
Item # M44761
U/M - Each

Please note: #6 Cove Base is also available with a bull nose top cap. It is not displayed in above photo. Sold per each
Item # M44707

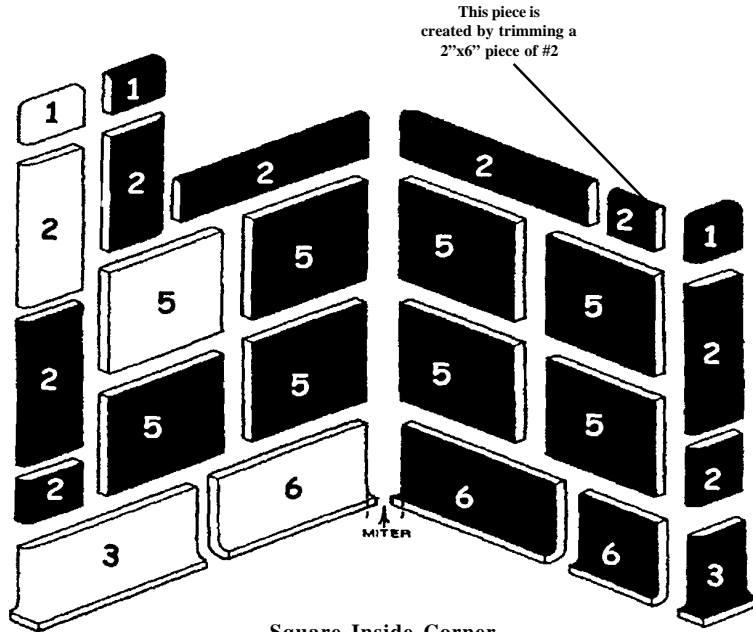

Square Inside Corner Installation with Round Outside Corners

Example #1

Tile Adhesive
Page 154

Tile Grout
Page 155

Tile Cutters
Page 65 & 66

#7 Outside Corner :

- White
- 4-1/4"x4-1/4"
- Sold per each
Item # M44746
U/M - Each

#8 Bullnose Cap :

- White
- 4-1/4"x4-1/4"
- Sold per each
Item # M44716
U/M - Each

#10 Square :

- White
- 4-1/4"x4-1/4"
- Sold per case, 12sf per case
Item # M44526
U/M - Case

#11 Bullnose Corner Cove Base :

- White
- 4-1/4"x4-1/4"
- Sold per each
Item # M44757
U/M - Each

#12 Cove Base :

- White
- 4-1/4"x4-1/4"
- Sold per each
Item # M44742
U/M - Each

Example #2

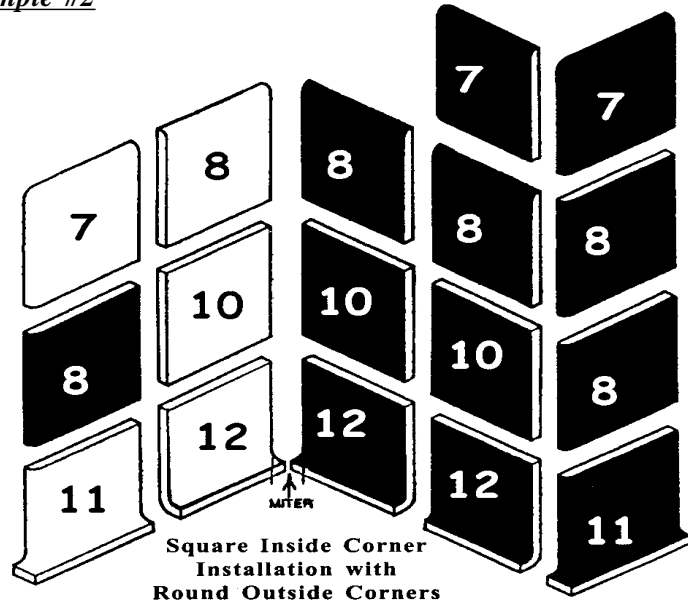

Square Inside Corner Installation with Round Outside Corners



MILL SUPPLY CO., INC.

Phone (410) 485-3343
Fax (410) 325-2240

Toll Free 1-800-817-8183

Construction & Building Supplies

CERAMIC FLOOR TILES & FIXTURES

Mosaic Floor Tile :

- 2"x2"
- Sheets are 6 squares by 12 squares
- Sheets and tiles can be trimmed to fit
- Glazed finish
- 12 sheets per case
- 24 square feet per case
- Sold per case only

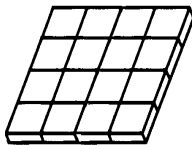

Item #	U/M	Color
M44567	Case	White
M44572	Case	Almond

Ceramic Floor Tile :

- 4-1/4"x4-1/4"
- Glazed white finish
- 12 square feet per case
- Sold per case only

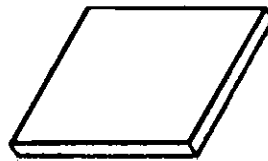

Item # M44531
U/M - Case

Toothbrush/Tumbler Holder :

- Glazed white finish
- Includes all mounting hardware

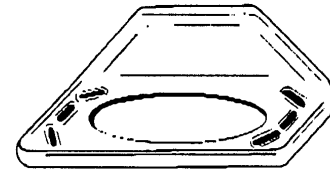

Item #	U/M	Style	Tile Size
M44646	Pair	Clip on	-N/A-
M44641	Pair	Grout on	4.25"x4.25"

Soap Dish :

- Glazed white finish
- "Clip on" for wall (M44611) includes all mounting hardware
- "Grout on" for wall (M44607)
- "Grout on" for wall in bath tub (M44604) tray sits lower specifically for bath tub applications

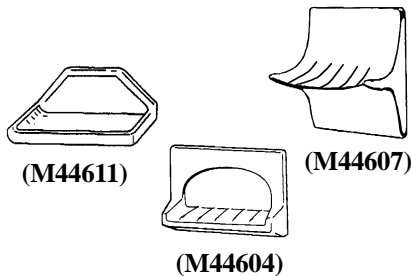

Item #	U/M	Style	Tile Size
M44611	Each	Clip on	-N/A-
M44607	Each	Grout on	4.25"x4.25"
M44604	Each	Grout on	4.25"x6.125"

Paper Holder :

- Glazed white finish
- Includes all mounting hardware
- Includes roller

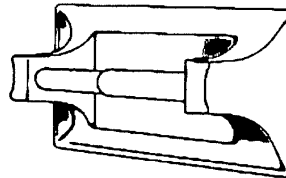

Item #	U/M	Style	Tile Size
M44623	Each	Clip on	-N/A-
M44619	Each	Grout on	4.25"x6.125"

Replacement Spring End White

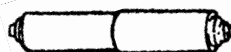

Item # M34615
U/M - Each

Towel Bar Post :

- Glazed white finish
- Includes all mounting hardware
- Sold by the pair only
- Bar not included



Item #	U/M	Style	Tile Size
M44632	Pair	Clip on	-N/A-
M44626	Pair	Grout on	4.25"x2.125"

Replacement Towel Bar

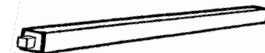

Item #	U/M	Size	Color	Spring Ends
M38585	Each	24"	White	Not Included
M38584	Each	24"	White	Included

Replacement Spring End

Item # M38599
U/M - Each



MILL SUPPLY CO., INC.

Phone (410) 485-3343
Fax (410) 325-2240

Toll Free 1-800-817-8183

Construction & Building Supplies

VINYL & PARQUET FLOORING

Vinyl No-Wax Tile :



- 12"x12"
- Self-adhering
- 3-year limited warranty
- Vinyl no-wax wear layer
- Printed construction
- #28650 White
- Vernay Series
- 45sf per case
- Sold per case only

Montelena®

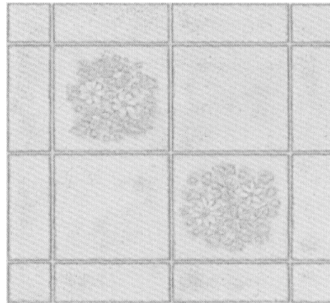

Commerercial Floor Tile :



- 12"x12"
- Through-pattern construction means color and design are retained for the life of the floor
- Available in 1/8" and 3/32" for different cost and performance needs
- Not self-adhering
- #51858 Sandrift White
- 45sf per case
- Sold per case only

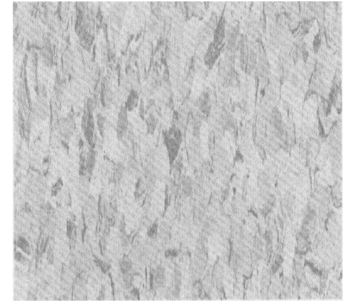

Item # M43003
U/M - Case



Item #	U/M	Size	Durability
M43005	Case	3/32"	Good
M43006	Case	1/8"	Very Good

Vinyl No-Wax Tile :



- 12"x12"
- Self-adhering
- 3-year limited warranty
- Super-tough, high gloss urethane wear surface for excellent resistance to dirt and scuffs
- Easy maintenance
- #WR-11 Titanium
- 45sf per case
- Sold per case only



Item # M43156
U/M - Case

Block Parquet :



- 9"x9" beveled edged, tongue and groove squares
- 3ply, 1/2" thick engineered oak
- Dura-stain wax finish
- Glue-down installation
- Toast color
- 18sf per case
- Sold per case only



Item # M43106
U/M - Case



MILL SUPPLY CO., INC.

Phone (410) 485-3343
Fax (410) 325-2240

Toll Free 1-800-817-8183

Construction & Building Supplies

DOORS

Pre-Hung Doors :

- Hollow core hardboard doors
- Flush
- 4-5/8" two piece split jambs
- 11/16" x 2-1/4" #327 ranch casing attached on both sides
- Jamb and casing are both finger joint pine

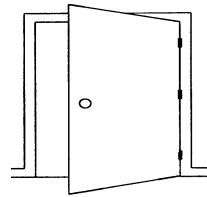

Left Hand

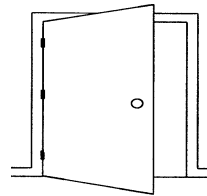

Right Hand

Item #	U/M	Size	Hand
M41080	Each	2/0" x 6/8"	Left
M41081	Each	2/0" x 6/8"	Right
M41085	Each	2/4" x 6/8"	Left
M41086	Each	2/4" x 6/8"	Right
M41090	Each	2/6" x 6/8"	Left
M41091	Each	2/6" x 6/8"	Right
M41095	Each	2/8" x 6/8"	Left
M41096	Each	2/8" x 6/8"	Right

Bi-Fold Doors :

- Hollow core hardboard doors
- Flush
- Includes all mounting hardware
- Door can be mounted for left or right fold open (2 panel styles)

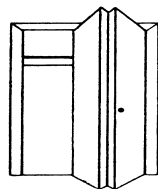

2 Panel

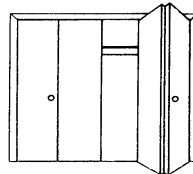

4 Panel

Bi-Fold Door Hardware
Page 107-109

Item #	U/M	Size	Panel
M41031	Each	2/0" x 6/7"	2
M41035	Each	2/6" x 6/7"	2
M41037	Each	2/8" x 6/7"	2
M41039	Each	3/0" x 6/7"	2
M41043	Each	4/0" x 6/7"	4
M41045	Each	5/0" x 6/7"	4
M41047	Each	6/0" x 6/7"	4

Door Slabs :

- Hollow core hardboard doors
- Flush
- Minimum of 1-1/4" stiles, top and bottom rails
- Can be trimmed to fit

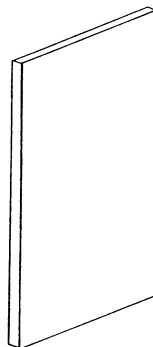

Item #	U/M	Size
M41003	Each	2/0" x 6/8"
M41006	Each	2/4" x 6/8"
M41011	Each	2/6" x 6/8"
M41014	Each	2/8" x 6/8"
M41016	Each	3/0" x 6/8"

Accordion Doors :

- Solid vinyl - wipes clean
- Can be installed for either left or right hand opening
- Fashionable, functional - for closets, doorways, partitions
- Smooth, quiet, trouble-free operation
- Installs in minutes with basic household tools
- Includes instructions and all hardware
- Color - Walnut

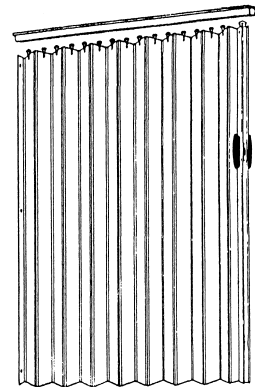

Item #	U/M	Size WxH	Fits Opening Size
M41051	Each	32" x 80"	24" to 32"
M41054	Each	36" x 80"	32" to 36"
M41058	Each	48" x 80"	36" to 48"



MILL SUPPLY CO., INC.

Phone (410) 485-3343
Fax (410) 325-2240

Toll Free 1-800-817-8183

Construction & Building Supplies

SCREWS

Machine Screws :

- Combination Head*, Zinc Plated Steel
- Sold per box only
- 100 per box

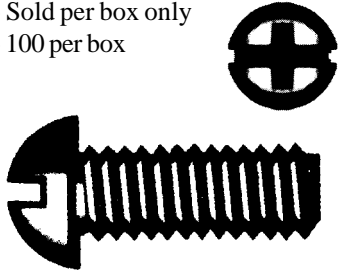

LENGTH	DIAMETERS				
	6/32	8/32	10/24	10/32	1/4-20
3/8"	M47508	M47509	-	-	-
1/2"	M47524	M47525	M47526	M47527	M47529
5/8"	-	-	-	-	M47539
3/4"	M47545	M47546	M47547	M47548	M47550
1"	M47565	M47566	M47567	M47568	M47570
1-1/4"	M47576	M47577	M47578	M47579	M47581
1-1/2"	M47587	M47588	M47589	M47590	M47592
1-3/4"	M47596	M47597	M47598	M47599	M47600
2"	M47605	M47606	M47607	M47608	M47610

* Items in grey are slotted head, they are not yet available in a combination head.

Self Drilling Screws :

- Hex Washer Head, Zinc Plated Hardened Steel
- Sold per box only
- 100 per box

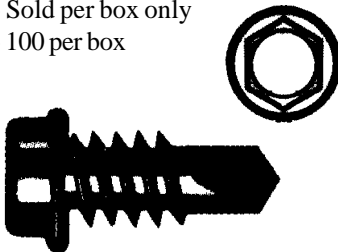

LENGTH	DIAMETERS			
	6-20	8-18	10-16	12-14
1/2"	M47317	M47318	M47319	-
3/4"	M47327	M47328	M47329	M47330
1"	M47332	M47333	M47334	M47335
1-1/4"	M47337	M47338	M47339	M47340
1-1/2"	M47347	M47348	M47349	M47350
2"	-	M47353	M47354	M47355

Self Drilling Screws :

- Pan Head Phillips Head, Zinc Plated Hardened Steel
- Sold per box only
- 100 per box

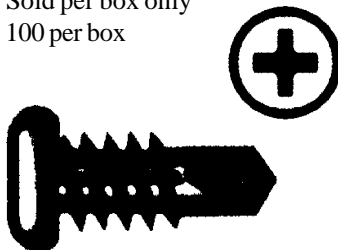

LENGTH	DIAMETERS		
	6-20	8-18	10-16
1/2"	M47368	M47369	M47370
3/4"	M47374	M47375	M47376
1"	M47377	M47378	M47379
1-1/4"	M47380	M47381	M47382
1-1/2"	M47386	M47387	M47388
2"	-	M47390	M47391



MILL SUPPLY CO., INC.

Phone (410) 485-3343
Fax (410) 325-2240

Toll Free 1-800-817-8183

Construction & Building Supplies

SCREWS

Sheet Metal Screws :

- Pan Head Phillips Head,
Zinc Plated Steel
- Sold per box only
- 100 per box

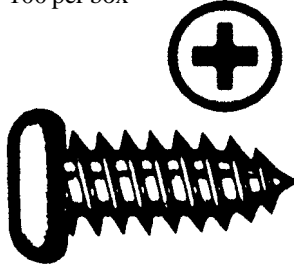

LENGTH	DIAMETERS			
	6	8	10	12
1/2"	M47003	M47005	-	-
5/8"	M47010	M47012	-	-
3/4"	M47017	M47019	M47020	M47021
1"	M47031	M47033	M47034	M47035
1-1/4"	M47038	M47040	M47041	M47042
1-1/2"	M47045	M47047	M47048	M47049
2"	M47059	M47061	M47062	M47063
2-1/2"	-	M47068	M47069	M47070
3"	-	-	M47076	M47077

Sheet Metal Screws :

- Flat Head Phillips Head,
Zinc Plated Steel
- Sold per box only
- 100 per box

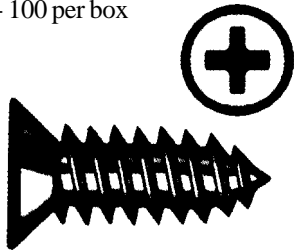

LENGTH	DIAMETERS			
	6	8	10	12
1/2"	M46920	M46922	-	-
5/8"	M46927	M46929	-	-
3/4"	-	-	M46936	M46937
1"	M46940	M46942	M46943	M46944
1-1/4"	M46947	M46949	M46950	M46951
1-1/2"	M46954	M46956	M46957	M46958
2"	M46968	M46970	M46971	M46972
2-1/2"	-	M46977	M46978	M46979
3"	-	-	M46985	M46986

Drywall Screws :

- **Coarse thread**, sharp point
- #2 Phillips head
- For drywall or wood to
wood applications
- Black finish

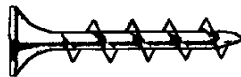

Drywall Screws :

- **Fine thread**, sharp point
- #2 Phillips head
- All purpose screw used in
light gauge metal or wood
- Black Phos. finish



Size	5lb Box #	Carton #	Carton Weight / Count
#6 x 1"	M47676	M47677	31 LBS / 10000
#6 x 1-1/4"	M47678	M47679	27 LBS / 8000
#6 x 1-5/8"	M47680	M47681	22 LBS / 5000
#6 x 2"	M47682	M47683	19 LBS / 3500
#8 x 2-1/2"	M47686	M47687	19 LBS / 2500
#8 x 3"	M47688	M47689	21 LBS / 2000
#10 X 4"	M47694	M47695	23 LBS / 1000

Size	5lb Box #	Carton #	Carton Weight / Count
#6 x 1"	M47697	M47698	31 LBS / 10000
#6 x 1-1/4"	M47701	M47702	28 LBS / 8000
#6 x 1-5/8"	M47703	M47704	22 LBS / 5000
#6 x 2"	M47705	M47706	19 LBS / 3500
#8 x 2-1/2"	M47709	M47710	23 LBS / 2500
#8 x 3"	M47711	M47712	21 LBS / 2000
#10 x 3-3/4"	M47715	M47716	26 LBS / 1500



MILL SUPPLY CO., INC.

Phone (410) 485-3343
Fax (410) 325-2240

Toll Free 1-800-817-8183

Construction & Building Supplies

SCREWS

Framing Screws :

- Pan Head Phillips Head,
Black Phos.
- Sharp point
- 6x7/16
- Sold per 5lb. box only
- Aprox. 2080 per box



Item # M47302
U/M - Box

Hex Cap Screws :

- Grade 2 Low Carbon USS
(Coarse Thread)
Zinc Plated
- Screws only
- Sold per box



LENGTH	DIAMETERS			
	1/4	5/16	3/8	1/2
1/2"	M48017	M48018	-	-
3/4"	M48023	M48024	M48025	-
1"	M48031	M48032	M48033	M48035
1-1/2"	M48045	M48046	M48047	M48049
2"	M48062	M48063	M48064	M48066
2-1/2"	M48080	M48081	M48082	M48084
3"	M48098	M48099	M48100	M48102
3-1/2"	M48115	M48116	M48117	M48119
4"	M48133	M48134	M48135	M48137
5"	-	-	M48153	M48155
6"	-	-	M48171	M48173

Carriage Screws :

- Round Head (Square Neck)
USS Thread (Grade 2) Zinc Plated
- Screws only
- Sold per box

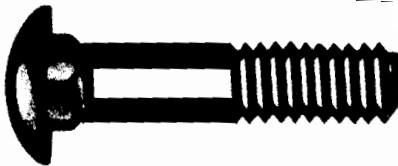

Lag Screws :

- Hex Head Zinc Plated
- Screws only
- Sold per box



LENGTH	DIAMETERS			
	1/4	5/16	3/8	1/2
3/4"	M47737	M47738	M47739	-
1"	M47745	M47746	M47747	M47749
1-1/4"	M47753	M47754	-	-
1-1/2"	M47761	M47762	M47763	M47765
2"	M47777	M47778	M47779	M47781
2-1/2"	M47793	M47794	M47795	M47797
3"	M47809	M47810	M47811	M47813
3-1/2"	M47825	M47826	M47827	M47829
4"	M47841	M47842	M47843	M47845
5"	-	-	M47859	M47861
6"	-	-	M47875	M47877

LENGTH	DIAMETERS			
	1/4	5/16	3/8	1/2
1"	M47936	M47937	M47938	-
1-1/4"	M47939	M47940	M47941	-
1-1/2"	M47942	M47943	M47944	M47945
2"	M47949	M47950	M47951	M47952
2-1/2"	M47954	M47955	M47956	-
3"	M47959	M47960	M47961	M47962
3-1/2"	M47965	M47966	M47967	-
4"	M47971	M47972	M47973	M47974
5"	-	-	M47984	M47985
6"	-	-	M47995	M47996

Key :

100 per box

50 per box

25 per box



MILL SUPPLY CO., INC.

Phone (410) 485-3343
Fax (410) 325-2240

Toll Free 1-800-817-8183

Construction & Building Supplies

WASHERS

Flat Washers :

- Flat USS Standard
- C-Pak, Zinc Plated
- Sold per box only



Machine Screw Washers :

- Zinc Plated
- Sold per box only



DIAMETER	Item #	LD.	O.D.	Aprox. Thickness
3/16"	M48902	1/4"	9/16"	3/64"
1/4"	M48903	5/16"	3/4"	1/16"
5/16"	M48904	3/8"	7/8"	5/64"
3/8"	M48905	7/16"	1"	5/64"
1/2"	M48907	9/16"	1-3/8"	7/64"

DIAMETER	Item #	LD.	O.D.	Aprox. Thickness
4	M48915	1/8"	9/32"	1/32"
6	M48917	5/32"	3/8"	1/32"
8	M48918	11/64"	3/8"	1/32"
10	M48919	13/64"	7/16"	1/32"
12	M48920	7/32"	1/2"	3/64"

MACHINE SCREW WASHER PACKAGING	
DIAMETER	BOX QUANTITY
4	2400
6	1300
8	1100
10	1100
12	465

Fender Washers :

- Zinc Plated
- Sold per box only



Lock Washers :

- Zinc Plated
- Split Medium
- Sold per box only



O.D.	SCREW SIZE DIAMETER				
	3/16"	1/4"	5/16"	3/8"	1/2"
1"	M48925	M48926	-	-	-
1-1/2"	-	M48931	M48932	M48933	M48934
2"	-	-	-	M48937	-

DIAMETER	Item #	LD. MAX	O.D. MAX
10	M48946	.202	.334
1/4"	M48948	.263	.489
5/16"	M48949	.328	.586
3/8"	M48950	.393	.683
1/2"	M48952	.523	.873

Key :

100 per box

50 per box



MILL SUPPLY CO., INC.

Phone (410) 485-3343
Fax (410) 325-2240

Toll Free 1-800-817-8183

Construction & Building Supplies

NUTS

Machine Screw Nuts :

- Hex Head
- Zinc Plated
- Sold per box only



DIAMETER	Item #	W.A.F.*	Thickness
6-32	M46709	5/16"	7/64"
8-32	M46711	11/32"	1/8"
10-24	M46712	3/8"	1/8"
10-32	M46713	3/8"	1/8"
1/4-20	M46715	7/16"	7/32"

Coarse Thread Nuts :

- Hex Head
- Zinc Plated
- Sold per box only



DIAMETER	Item #	W.A.F.*	Thickness
1/4-20	M46715	7/16"	7/32"
5/16-18	M46717	1/2"	17/64"
3/8-16	M46718	9/16"	21/64"
1/2-13	M46720	3/4"	7/16"

Heavy Hex Nuts :

- Hex Head
- Zinc Plated
- Sold per box only



DIAMETER	Item #	W.A.F.*	Thickness
1/4-20	M46732	1/2"	15/64
5/16-18	M46733	9/16"	19/64
3/8-16	M46734	11/16"	23/64
1/2-13	M46736	7/8"	31/64

Wing Nuts :

- Zinc Plated
- Sold per box only



DIAMETER	Item #	Max. Wing Spread	Max. Wing Height
6-32	M46851	.720	.410
8-32	M46852	.910	.470
10-24	M46853	.910	.470
10-32	M46854	.910	.470
1/4-20	M46855	1.10	.570

* Width Across Flats

Key :

100 per box

50 per box



MILL SUPPLY CO., INC.

Phone (410) 485-3343
Fax (410) 325-2240

Toll Free 1-800-817-8183

Construction & Building Supplies

FASTENERS

Lag Screw Shields :

- Zinc alloy
- Die cast
- Sold per box only



Size	Item#	Drill Size	Length
1/4" Long	M49706	1/2"	1-1/2"
1/4" Short	M49707	1/2"	1"
5/16" Long	M49708	1/2"	1-3/4"
5/16" Short	M49709	1/2"	1-1/4"
3/8" Long	M47910	5/8"	2-1/2"
3/8" Short	M49711	5/8"	1-3/4"
1/2" Long	M49712	3/4"	3"
1/2" Short	M49713	3/4"	2"

Toggle Bolts :

- Combination head
- Round head / Spring wings
- Sold per box only

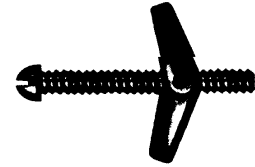

Size	Item#	Drill Size
1/8x2 (6-32)	M49675	1/2"
1/8x3 (6-32)	M49676	1/2"
1/8x4 (6-32)	M49677	1/2"
3/16x2 (10-24)	M49678	1/2"
3/16x3 (10-24)	M49679	5/8"
3/16x4 (10-24)	M49680	5/8"
1/4 x 3	M49683	3/4"
1/4 x 4	M49684	3/4"

Plastic Anchors :

- Tapered-Flanged
- Conical
- Can be used with wood or sheet metal screws
- Sold per box only

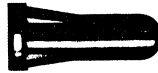

Screw Size	Item#	Drill Size	Length
6-8	M49731	3/16"	3/4"
8-10	M49732	3/16"	7/8"
10-12	M49733	1/4"	1"
14-16	M49734	5/16"	1-3/8"

Plastic Anchor Kit :

- Kit includes, 100/ea sheet metal screws, 100/ea plastic anchors, 1/ea masonry drill bit, and kit box
- Combination Phillips / Slotted head sheet metal screws
- Pan head sheet metal screws
- Kits are sold by the each

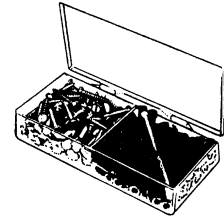

Screw Size	Item#	Drill Bit Size	Anchor Length
6-8	M49723	3/16"	3/4"
10-12	M49725	1/4"	1"

E-Z Anchors :

- Available in zinc or nylon
- No pre-drilling required
- Sold per box only



Type	Item#	Screw Size	Length
Jr. Nylon	M49362	8-10	1-5/16"
Nylon	M49363	10-12	1-11/16"
Zinc	M49364	10-12	1-11/16"

Hollow Wall Anchors :

- Zinc Plated
- Sold per box only



Size	Item#	Drill Size	Body Length
1/8 S (4S)	M49303	1/4"	1-1/4"
1/8 L (4L)	M49304	1/4"	1-11/16"
3/16 S (6S)	M49306	3/8"	2-1/16"
3/16 L (6L)	M49307	3/8"	2-9/16"
1/4 S (8S)	M49309	1/2"	2-1/16"
1/4 L (8L)	M49310	1/2"	2-9/16"

Key :

100 per box

50 per box



MILL SUPPLY CO., INC.

Phone (410) 485-3343
Fax (410) 325-2240

Toll Free 1-800-817-8183

Construction & Building Supplies

NAILS / WIRE BRADS

Bright Common Nails :

- Diamond point
- Sold per 1 lb. box only



Item #	U/M	Size
M46504	Box	6D
M46505	Box	8D
M46506	Box	10D
M46507	Box	12D
M46508	Box	16D

Bright Finishing Nails :

- Smooth shank
- Sold per 1 lb. box only



Item #	U/M	Size
M46518	Box	4D
M46519	Box	6D
M46520	Box	8D
M46521	Box	10D
M46523	Box	16D

Masonry Nails :

- Diamond point
- Temper hardened steel
- Flat head / Fluted shank
- Sold per 1 lb. box only



Item #	U/M	Length
M46533	Box	1"
M46534	Box	1-1/2"

Roofing Nails :

- Barbed shank
- Electro-galvanized
- Sold per 1 lb. box only



Item #	U/M	Length
M46576	Box	1-1/4"

Panel Nails :

- Annular thread
- Available in brown or white
- Sold per 1 lb. pack only



Item #	U/M	Length	Color
M46539	Pack	1"	Brown
M46540	Pack	1-5/8"	Brown
M46542	Pack	1"	White
M46543	Pack	1-5/8"	White

Wire Brads :

- Sold per 2 oz. pack only
- Steel
- Bright finish



Item #	U/M	Length	Gauge
M46658	Pack	3/4"	16
M46662	Pack	1"	16



MILL SUPPLY CO., INC.

Phone (410) 485-3343
Fax (410) 325-2240

Toll Free 1-800-817-8183



Lawn & Garden

Lawn & Garden

UnionTools
Quality You Can Count On

SWAN

Gilmour.

Roundup

ORTHO

SONO

EarthWay

CHAPIN

**BLACK
FLAG**



MILL SUPPLY CO., INC.

Phone (410) 485-3343
Fax (410) 325-2240

Toll Free 1-800-817-8183

Lawn & Garden

SNOW SHOVELS / PUSHERS / SCRAPERS

Poly Snow Shovel :

- 20" combo "snow plow" blade
- Wear strip increases durability
- Coated blade makes tossing snow easier
- Ergonomic 40" metal handle
- Big D-grip reduces fatigue

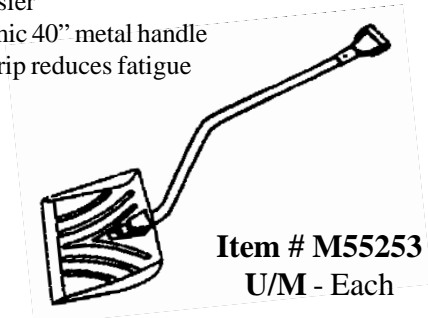

Poly "Snow Plow" Shovel :

- Design makes removal easier by eliminating build up in front of blade
- 20" blade with double sided aluminum wear strip that extends the life of the blade
- 36" ash handle
- Ergo D-grip reduces fatigue

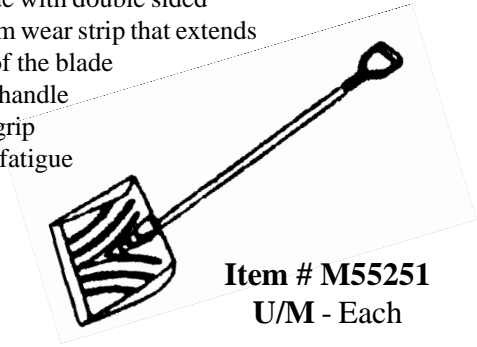

Poly Snow Shovel :

- 18" wide poly blade
- Deep ribbed, scoop style blade
- White Ash Handle
- Ergo D-grip reduces fatigue



Steel Snow Shovel :

- Steel blade
- 18" wide blade
- Non-sticking coated blade
- Ergo D-grip reduces fatigue
- White ash handle
- Heavy duty design

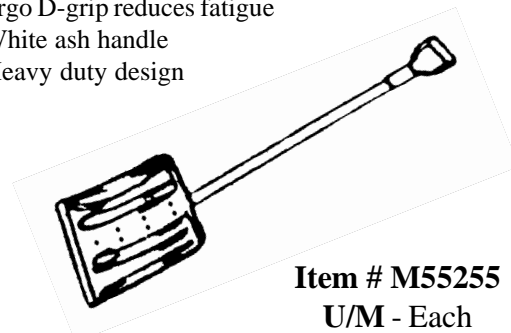

Premium Snow Pusher :

- Steel blade
- 24" wide blade
- Non-sticking coated blade
- Ergo D-grip reduces fatigue
- White ash handle
- Braced handle for extra durability
- Heavy duty design

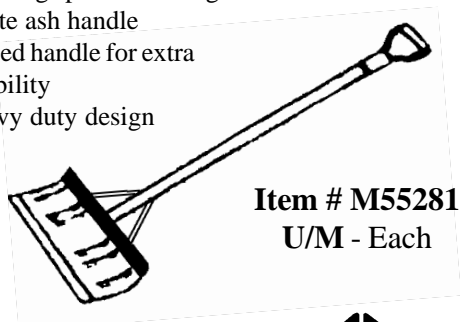

Steel Ice Scraper :

- Sidewalk and ice scraper
- 7" wide blade
- 54" white ash handle
- Also good for scraping wood and concrete floors
- Heavy socket pattern head

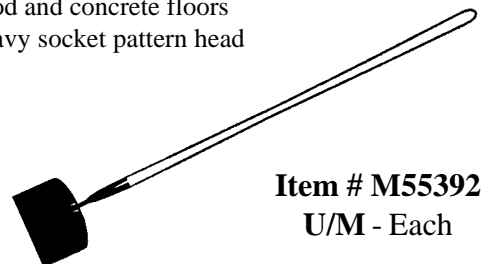

MILL SUPPLY CO., INC.

Phone (410) 485-3343
Fax (410) 325-2240

Toll Free 1-800-817-8183

Lawn & Garden

SHOVELS

Round Point Shovel :

- Contractor grade
- #2 size, open back
- 9-1/2" x 12" industrial-gauge blade
- Rolled step
- 2-rivet, 11" tab socket
- 48" lacquered premium ash handle

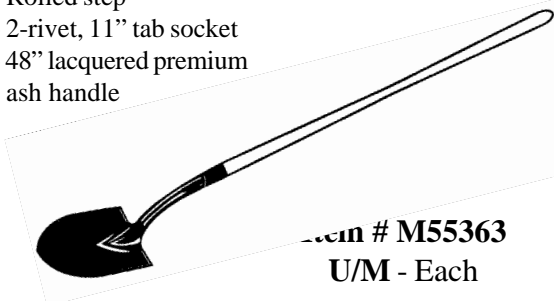

Item # M55363
U/M - Each

Round Point Shovel :

- #2 size, open back
- 9-1/4" x 11-1/2" blade
- Rolled step
- 9" socket
- 47" lacquered ash handle

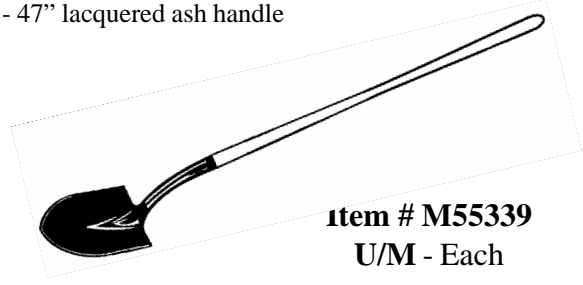

Item # M55339
U/M - Each

Round Point Shovel :

- Contractor grade
- #2 size, open back
- 9-1/2" x 12" industrial-gauge blade
- Rolled step
- 2-rivet, 11" tab socket
- 30" lacquered premium ash handle with steel and wood D-grip

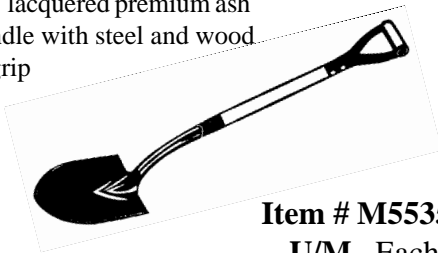

Item # M55351
U/M - Each

Square Point Shovel :

- #2 size, open back
- 9-1/4" x 11-1/2" blade
- Rolled step
- 9" socket
- 28" lacquered ash handle with steel and wood D-grip

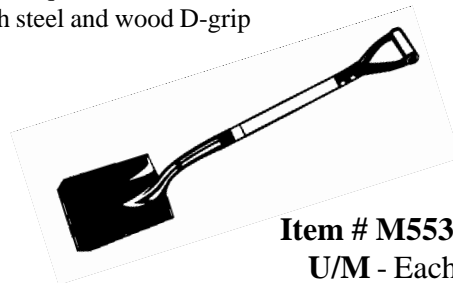

Item # M55345
U/M - Each

Square Point Shovel :

- Contractor grade
- #2 size, open back
- 9-1/2" x 12" industrial-gauge blade
- Rolled step
- 2-rivet, 11" tab socket
- 48" lacquered premium ash handle

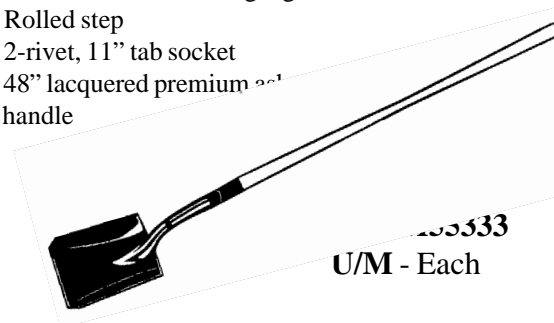

Item # M55333
U/M - Each

Square Point Shovel :

- #2 size, open back
- 9-1/4" x 11-1/2" blade
- Rolled step
- 9" socket
- 47" lacquered ash handle

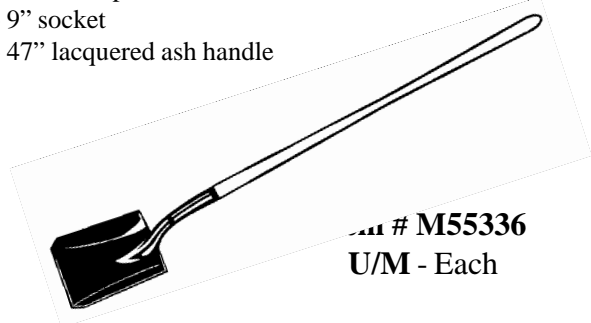

Item # M55336
U/M - Each



MILL SUPPLY CO., INC.

Phone (410) 485-3343
Fax (410) 325-2240

Toll Free 1-800-817-8183

Lawn & Garden

SHOVELS / SCOOPS / POST HOLE DIGGERS

General Purpose Shovel :



- #2 size
- 11-1/2" x 14-1/4" steel blade
- 46" lacquered ash handle

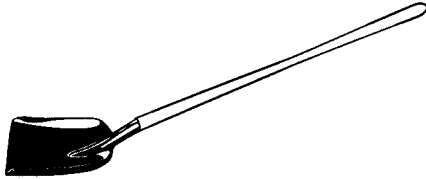

Item # M55270
U/M - Each

Steel Scoop :



- #2 size
- 11" x 15" heavy-gauge blade
- Western pattern
- 48" lacquered ash handle

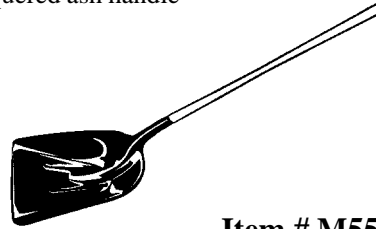

Item # M55314
U/M - Each

Aluminum Scoop :



- Contractor grade
- #12 size
- 14-3/4" x 18-3/4", .101" thick blade
- Western pattern
- Etched finish
- 31" premium ash handle with steel and wood D-grip



Item # M55315
U/M - Each

Steel Scoop :



- #2 size
- 11" x 15"
- Eastern pattern blade
- 27" lacquered ash handle with steel and wood D-grip

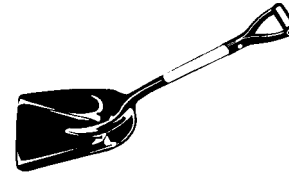

Item # M55303
U/M - Each

Drain Spade :



- Open back
- 4-3/4" x 14" blade
- Forward turned step
- 9" socket
- 27" lacquered ash handle with oversized poly D-grip to fit a gloved hand

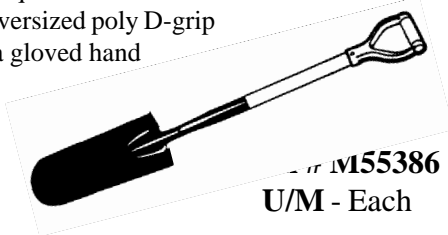

Item # M55386
U/M - Each

Post Hole Diggers :



- 5" x 10-1/4" high carbon steel blades
- One piece blade design for superior strength
- 48" premium ash handles

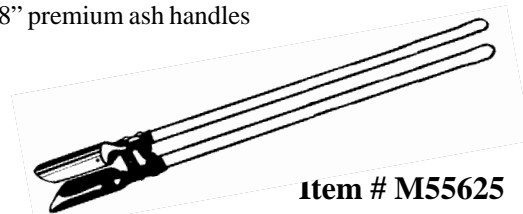

Item # M55625
U/M - Each



MILL SUPPLY CO., INC.

Phone (410) 485-3343
Fax (410) 325-2240

Toll Free 1-800-817-8183

Lawn & Garden

Lawn & Garden

RAKES

Poly Leaf Rake :



- 24" lightweight polypropylene head
- 27 reinforced tines
- 48" lacquered hardwood handle

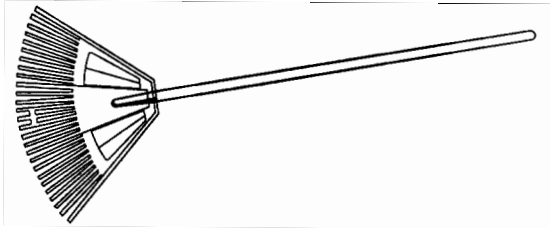

U/M - Each

Spring-Brace Lawn Rake :



- 22" spring steel head with coil-spring brace
- 22 spring steel tines
- 48" lacquered hardwood handle

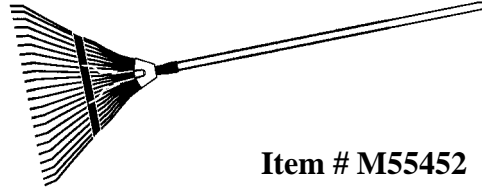

Item # M55452
U/M - Each

Road / Stone Rake :



- Contractor grade
- 15-1/2" x 4" forged head
- 11/32" thick head
- 14 extra-heavy straight teeth
- 66" lacquered premium ash handle

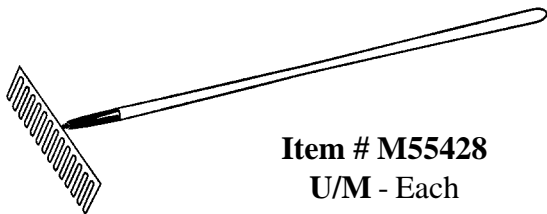

Item # M55428
U/M - Each

Road / Stone Rake :



- Contractor grade
- 17-3/4" x 4" forged head
- 11/32" thick head
- 16 extra-heavy straight teeth
- 66" lacquered premium ash handle

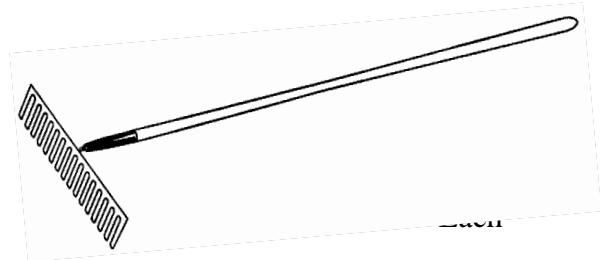

Asphalt / Tar Rake :



- Contractor grade
- 17" x 4-1/2" forged head
- 11/32" thick head
- 14 extra-heavy straight teeth
- 8" tube with cap
- 60" lacquered premium ash handle

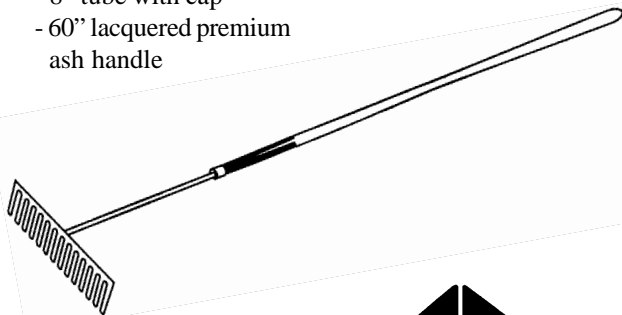

Welded Bow Rake :



- 14 teeth
- 13-3/4" x 2-3/4" welded head
- 3/16" thick head
- 54" lacquered ash handle

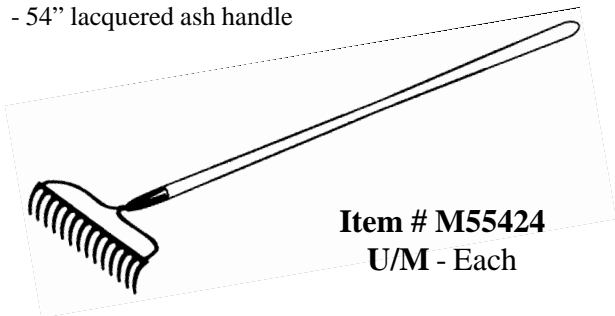

Item # M55424
U/M - Each

Lawn & Garden



MILL SUPPLY CO., INC.

Phone (410) 485-3343
Fax (410) 325-2240

Toll Free 1-800-817-8183

Lawn & Garden

HOES / FORKS / HAND GARDEN TOOLS

Mortar Mixer :

- Contractor Grade
- 10" x 6" one-piece forged blade
- Perforated for mixing
- 9" tube with cap
- 5/8" gooseneck shank
- 66" lacquered premium

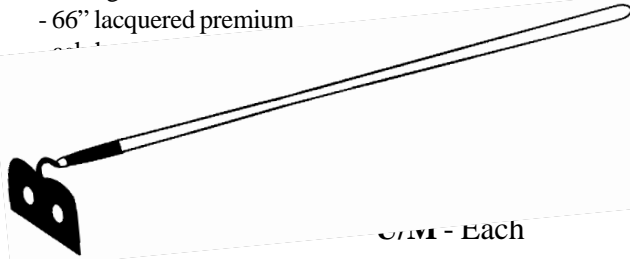

U/M - Each

Garden Hoe :

- Shank pattern
- 6-1/4" x 4-3/4" one piece forged beveled blade
- Gooseneck shank
- 54" fiberglass handle

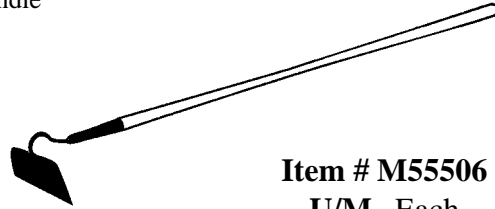

Item # M55506
U/M - Each

Manure Fork :

- 4 oval tines, 12-1/2" long, 8-3/4" spread at points
- One piece forged head
- 8" ferrule with cap
- 48" lacquered ash handle

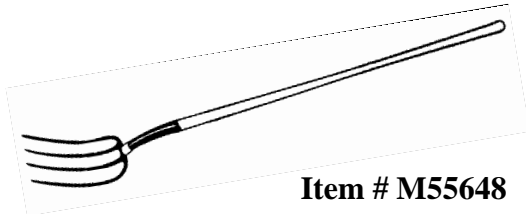

Item # M55648
U/M - Each

Potato / Refuse Hook :

- 4 heavy, broad, oval tines 7-1/2" long
- Diamond point
- One piece forged head
- 8" steel tube with cap
- 54" lacquered premium ash handle

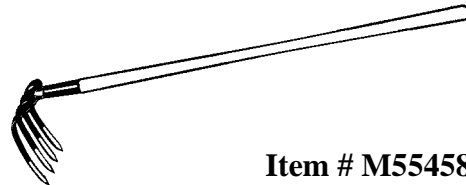

Item # M55458
U/M - Each

Garden Trowel :

- 3-1/4" x 5-1/2" blade
- 4-3/4" handle with poly grip
- 10-3/4" overall length

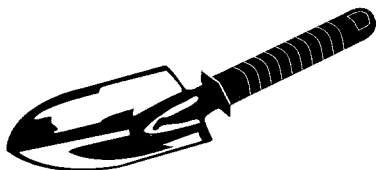

Item # M55631
U/M - Each

Cultivator :

- 3 tines, 1-1/4" spread at points
- 3-1/2" head width
- 4-3/4" handle with poly grip
- 10-3/8" overall length

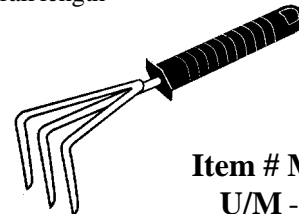

Item # M55632
U/M - Each



MILL SUPPLY CO., INC.

Phone (410) 485-3343
Fax (410) 325-2240

Toll Free 1-800-817-8183

Lawn & Garden

EDGERS & TRIMMERS

Rotary Lawn Edger :



- Serrated, self sharpening 3" x 1-1/2" blade
- Reversible cutting edge
- Paint coated
- 48" lacquered ash handle



Item # M55619
U/M - Each

Pole Pruner / Trimmer :



- 16" adjustable tempered steel blade
- 1-1/8" capacity non-stick coated spring action pruning blade
- Twin pulleys and power-lever give 22 times more pruning power
- 12' telescoping fiberglass pole

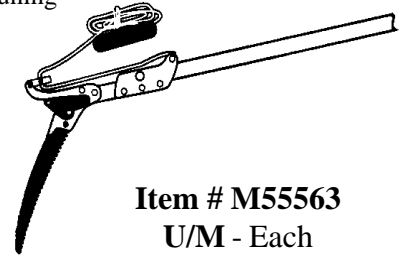

Item # M55563
U/M - Each

Pruning Shears :



- Adjustable anvil style
- Black oxide blade
- Comfort molded handle with hanger hole
- Stainless steel spring
- 7" overall length

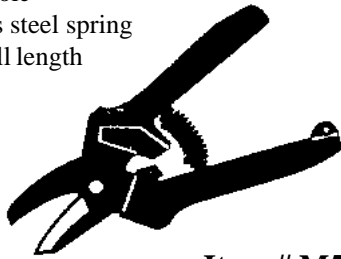

Item # M55603
U/M - Each

Grass Shears :



- Polished, chrome-carbide stainless steel blades
- 5" cut
- Zinc plated handles with cushion grips
- Safety lock
- 13-1/4" overall length

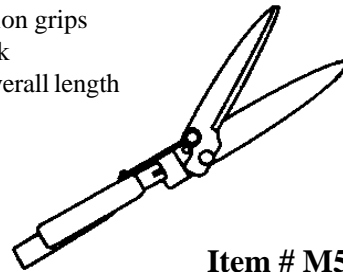

Item # M55584
U/M - Each

Hedge Shears :



- 10" blades with pruning notch and cushioned bumper
- Serrated top blade
- Lacquered hardwood handles with cushioned grips
- 21-1/2" overall length

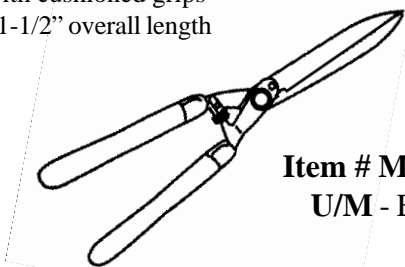

Item # M55594
U/M - Each

Loppers :



- Bypass style
- Non-stick coating on blades
- 1-1/4" cutting capacity
- Shaped hardwood handles
- 25" overall length

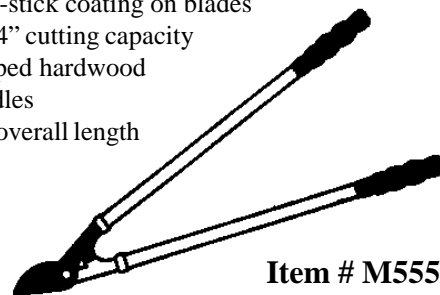

Item # M55586
U/M - Each



MILL SUPPLY CO., INC.

Phone (410) 485-3343
Fax (410) 325-2240

Toll Free 1-800-817-8183

Lawn & Garden

PICKS / MATTOCKS / TAMPERS / BARS

Picks / Mattocks :



Pick Mattock :

- Head only
- 5lb head weight
- 19-1/4" overall head length
- 3-1/2" wide blade width



Item # M55781
U/M - Each

Cutter Mattock :

- Head only
- 5lb head weight
- 15-1/2" overall head length
- 3-1/2" blade width
- 2-1/2" narrow blade width



Item # M55783
U/M - Each

Railroad Pick :

- Head only
- 6lb head weight
- 23" overall head length
- 1-7/16" wide blade width



Item # M55787
U/M - Each

Pick Handle :

- Fits our picks and mattocks
- 36" hickory

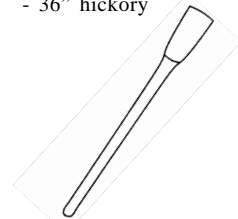

Item # M29119
U/M - Each

Tampers :

- Head only
- Cast Iron

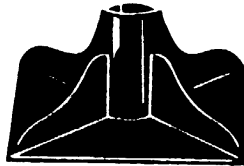

Item#	UM	Size
M55654	Each	8" x 8"
M55655	Each	10" x 10"

Tamper Handles :

- Either handle can fit either tamper head
- Made of ash

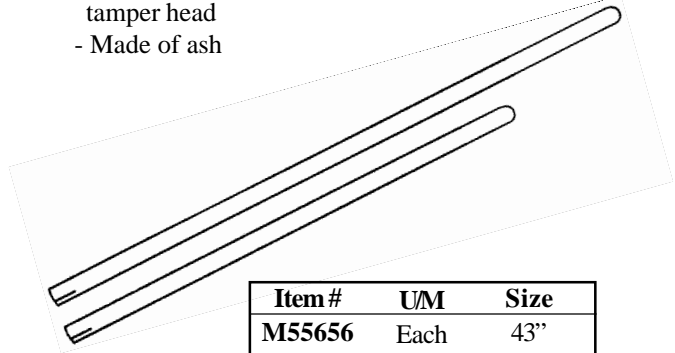

Item#	UM	Size
M55656	Each	43"
M55657	Each	60"

Heavy Bars :

Digger / Tamping Bar :

- 17lb
- 9-1/2" x 2" blade
- Straight pattern
- 72" overall length

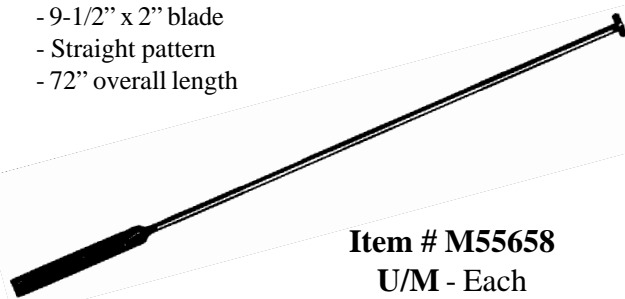

Item # M55658
U/M - Each

Pinch Point Crow Bar :

- 18lb
- 2-1/4" x 1" blade
- Straight pattern
- 60" overall length

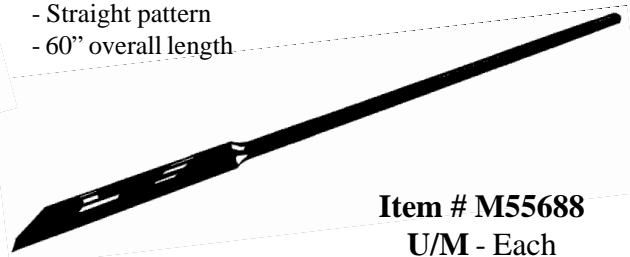

Item # M55688
U/M - Each



MILL SUPPLY CO., INC.

Phone (410) 485-3343
Fax (410) 325-2240

Toll Free 1-800-817-8183

Lawn & Garden

LAWN CARE / ICE MELT

Wheelbarrow :

- 6 cubic foot poly tray
- Standard duty undercarriage
- Wooden cross braces
- 2-ply radial tires

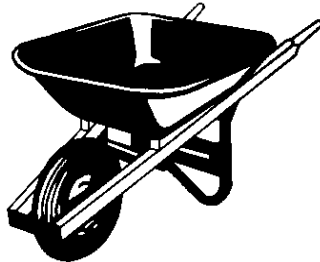

Item # M50014
U/M - Each

Broadcast Spreader :

- Rustproof high impact polypropylene hopper
- 80 lb capacity
- Heavy duty 8" diameter polypropylene wheels
- Large enclosed gears are permanently lubricated

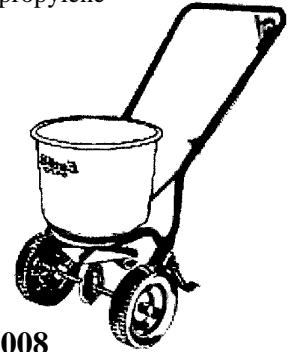

Item # M50008
U/M - Each

Magnesium Chloride :

- Starts working immediately
- Melts more ice at lower temperatures
- Leaves no residue
- Less damaging to concrete
- Safer to use
- Product contents :
Magnesium Chloride Hexahydrate 7791-18-6
Calcium Chloride (2.0-3.0%) 10043-52-4
Potassium Chloride (0.5-1.0%) 7447-40-7
Sodium Chloride (0.5-1.0%) 7647-14-5
- 50 lb Bag



Item # M65015
U/M - Each

Pallet Qty.
49/ea

Poly Sprayer :

- Actual capacity tank
- Easy disconnect / safety lock feature quick access for cleaning outlet
- 36" nylon reinforced hose to resist chemicals
- 12" curved poly / brass extension for easier reach
- Cleanable poly shut-off with lock-on for continuous spray
- Poly adjustable nozzle for fine mist to stream

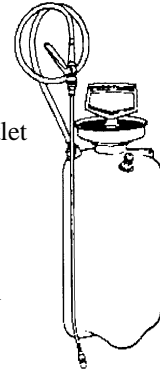

Item #	UM	Capacity
M50209	Each	2 gallon
M50213	Each	3 gallon

Grass Seed :

- Kentucky 31 tall fescue
- Perennial tall fescue
- Rugged, strong, dependable
- Heat tolerant
- Medium coarse texture

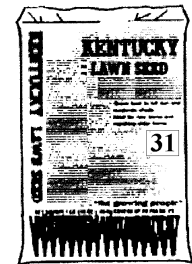

Item #	UM	Size
M50045	Each	25 lb Bag
M50049	Each	50 lb Bag



MILL SUPPLY CO., INC.

Phone (410) 485-3343
Fax (410) 325-2240

Toll Free 1-800-817-8183

Lawn & Garden

HOSE

Reinforced Garden Hose :

- Light-duty 3-ply design
- Knit reinforcing
- Flexible, easy handling
- Backed by a 2 year warranty
- 5/8" x 50'

swan



Item # M50328
U/M - Each

All-Weather Reinforced Garden Hose :

- 4-ply design for lasting durability
- Knit reinforced for flexibility
- Excellent kink resistance
- Brass couplings
- Backed by a 5 year warranty
- 5/8" x 50'

swan



Item # M50336
U/M - Each

Drip Irrigation Hose :

- Uses up to 70% less water than standard watering
- Water seeps through thousands of pores
- For use above ground or buried; fungus resistant
- Easy to clean
- 5/8" x 50'

swan



Item # M50312
U/M - Each

Commercial Grade Hose :

- Heavy-duty rubber / vinyl reinforced water hose
- Premium 5-ply construction
- Tough abrasion-resistant cover
- Dual reinforced for kink resistance
- Excellent pressure capacity
- Extra heavy-duty, crush proof, machined brass couplings
- Backed by a 10 year warranty

swan



Item #	U/M	Size
M50320	Each	5/8" x 50'
M50332	Each	3/4" x 50'



MILL SUPPLY CO., INC.

Phone (410) 485-3343
Fax (410) 325-2240

Toll Free 1-800-817-8183

Lawn & Garden

HOSE ACCESSORIES

Water Nozzle :



- Adjustable
- Leakproof
- Hold open clip
- Threaded acetal head insert with rubber seal for positive shut-off
- Full size zinc die cast body with durable powder coat finish



Item # M50390
U/M - Each

Hose Washers :

- 10 vinyl hose washers on a tear away sheet
- Tear-off "as you need design"
- Sold per sheet only

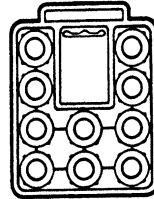

Item # M50346
U/M - Each

Hose Cap :

- Brass
- Replaces lost or missing hose cap
- Long lasting
- Crushproof



Item # M50411
U/M - Each

"Y" Connector :

- Rustproof polymer construction with high impact durability
- Twin shut-off valves to enable multi-tasking
- Not recommended for hot water use

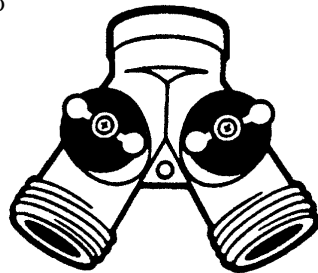

Item # M50381
U/M - Each

Hose Mender :

- Premium nylon construction with extreme durability
- For repairing plastic or rubber hose
- Leakproof
- Reusable
- Rustproof stainless steel screws

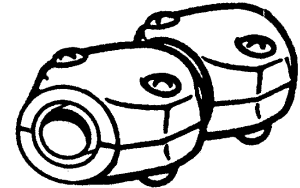

Item #	U/M	Fits Hose
M50363	Each	5/8" & 3/4"
M50369	Each	7/16" / 1/2" & 9/16"

Male Hose Coupler :

- Unbreakable
- Leakproof
- Rust proof screws
- Reusable

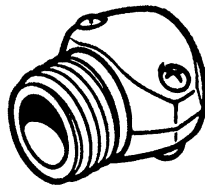

Item #	U/M	Fits Hose
M50347	Each	5/8" & 3/4"
M50350	Each	7/16" / 1/2" & 9/16"

Female Hose Coupler :

- Unbreakable
- Leakproof
- Rust Proof screws
- Reusable

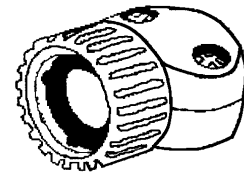

Item #	U/M	Fits Hose
M50348	Each	5/8" & 3/4"
M50351	Each	7/16" / 1/2" & 9/16"



MILL SUPPLY CO., INC.

Phone (410) 485-3343
Fax (410) 325-2240

Toll Free 1-800-817-8183

Lawn & Garden

HOSE ACCESSORIES / SPRINKLERS

Weed B Gone :

- Kills weeds not lawns
- Kills dandelion, clover & other broadleaf weeds
- Rain-proof in hours
- Includes nozzle sprayer
- 1 gallon

Not for use around fruits, vegetables or flowers.



Item # M65735
U/M - Each

Round Up :

- Kills all types of weeds and grasses
- Rain-proof in hours
- Includes nozzle sprayer
- 1 gallon

Can be used around fruits, vegetables, flowers, shrubs and trees.

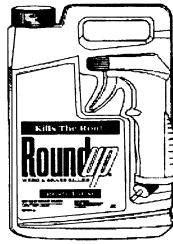

Item # M65740
U/M - Each

Vegetation Kill :

- Prevents plant growth for up to one year
- Easy to apply with a tank sprayer
- Eliminates unwanted vegetation out of driveways, walks, patios and fence rows
- Treats 300 square feet
- 1 gallon

Kills all growth.



Item # M65730
U/M - Each

Pulsating Sprinkler :

- "H" sled type base
- Full or part circle patterns are easily adjusted
- Furnished with two rubber washers, one on end cap and one on nozzle end
- Jet or mist spray determined by diffuser screw
- Rust resistant construction
- Waters up to 5,000 square feet

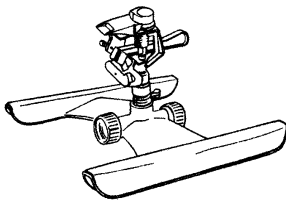

Item # M50259
U/M - Each

Pulsating Sprinkler :

- Spike "T" base
- Full or part circle patterns easily adjusted
- Adjustable distance control
- Connect multiple sprinklers with flow thru design
- Accepts most standard garden hoses
- Brass and plastic sprinkler head construction
- Zinc die cast spike construction
- Furnished with a strainer washer, sealer and shut off cap

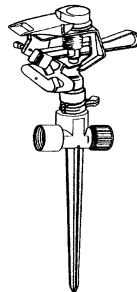

Item # M50256
U/M - Each

Oscillating Sprinkler :



- Adjustable spray patterns, rectangular and square shapes
- Long life, sealed water motor
- Maintenance free
- Precision spray jets for better coverage
- Covers up to 2,600 square feet

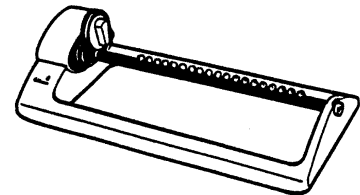

Item # M50271
U/M - Each



MILL SUPPLY CO., INC.

Phone (410) 485-3343
Fax (410) 325-2240

Toll Free 1-800-817-8183

Lawn & Garden

PEST CONTROL

Wasp & Hornet Spray :

- 20 foot spray
- Kills wasps, bees and hornets
- Guaranteed to work
- Kills fast
- No CFC's
- Outdoor use only
- 14 oz can



Item # M55821
U/M - Each

Shoo-fly Jet Bomb :

- 25 foot jet stream
- Outdoors it kills hornets, wasps, bees, yellow jackets, spiders, earwigs, ants and maggots
- Indoors it kills roaches, ants, waterbugs, silverfish, spiders and crickets
- Shoots into nests, eaves, crevices and holes
- Non-conductive up to 36,000 volts
- 12 oz can



Item # M55822
U/M - Each

Spring Mouse Trap :

- Non-poisonous
- Disposable
- Can be baited with any natural mouse attractants
- Sold per pack of two traps



Item # M55912
U/M - Pack

Glue Mouse Trap :

- Non-poisonous
- Child safe
- No springs
- Odorless
- Ready to use
- 3-1/2" x 4-1/2" traps
- Contains; 4 ready to use glue traps



Item # M55902
U/M - Each

Glue Rat Trap :

- Non-poisonous
- Child safe
- No springs
- Odorless
- Ready to use
- 5" x 10" traps
- Contains, 2 ready to use traps

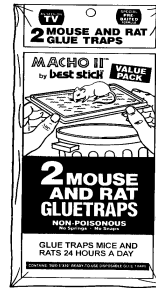

Item # M55921
U/M - Each

Ant Bait Stations :

- Quick kill formula
- Kills entire colony
- For common household ants
- 6 child resistant bait stations
- No vapor, fumes or odor



Item # M55802
U/M - Each

Ant & Roach Spray :

- For household use only
- Kills roaches, palmetto bugs, waterbugs, crickets, silverfish, spiders, ants, earwigs, flies, mosquitos, gnats and wasps
- Unscented
- Guaranteed to work
- 17.5 oz can



Item # M55809
U/M - Each

Indoor Fogger :

- Total release
- Kills cockroaches, fleas and flies
- Treats up to 5,000 cubic feet
- 5 oz can



Item # M55851
U/M - Each

Boric Acid :

- Easy applicator
- Kills cockroaches, palmetto bugs, waterbugs, ants and silverfish
- Long lasting
- Odorless
- Will not harden in bottle
- Safe for use in homes, hotels, apartments, school mobile homes, restaurant and warehouses
- 10 oz bottle



Item # M55805
U/M - Each





Janitorial

Janitorial



MILL SUPPLY CO., INC.

Phone (410) 485-3343
Fax (410) 325-2240

Toll Free 1-800-817-8183

Janitorial

BROOMS & BRUSHES

Whisk Broom :

- Made of selected fine broom corn
- No coarse corn
- Sewed two times, cad, plated ring cap
- 11 inch
- For home, office and automobile

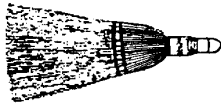

Item # M61625
U/M - Each

Lobby Broom :

- 100% natural corn fibers
- For indoor or outdoor use
- Removes fine dust particles from even the toughest surfaces
- 30" long wood handle
- Hand selected, heavy duty, lacquered pine handles

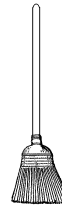

Item # M61443
U/M - Each

Janitor Broom :

- Selected corn and fiber broom
- Fan shaped
- Sewed 5 times
- 1" diameter handle
- Designed for smooth and rough floors having moderate dirt accumulations



Item # M61431
U/M - Each

Warehouse Broom :

- Selected corn and fiber broom
- Fan shaped
- Sewed 4 times
- Reinforced with a wire band
- 1-1/8" diameter handle
- Designed for smooth and rough floors having moderate to heavy dirt accumulations

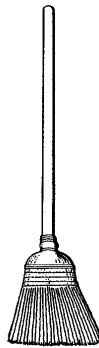

Item # M61437
U/M - Each

Small Angle Broom :

- Angled cut provides access to corners
- Polypropylene fibers
- Split tips
- Ring hook for hanging broom



Item # M61447
U/M - Each

Large Angle Broom :

- Angled cut provides access to corners
- Polypropylene fibers
- Split tips
- Larger head provides greater sweeping area
- Ring hook for hanging broom



Item # M61449
U/M - Each

Jumbo Angle Broom :

- Angled cut provides access to corners
- Polypropylene fibers
- Split tips
- Almost twice as thick as other angled brooms
- Larger diameter handle than other brooms
- Large sweeping area
- Ring hook for hanging broom

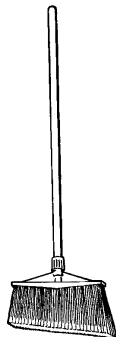

Item # M61448
U/M - Each

Soft Hair Floor Brush :

- Selected black tampico fiber in center
- Black polystyrene plastic and black horsehair mixture in border
- For sweeping smooth concrete floors, wood, asphalt, tile, etc.
- 3" thick bristles
- **Does not include handle**

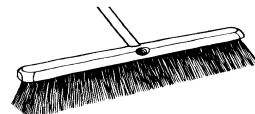

Item #	U/M	Size	Use Handle
M61296	Each	18"	M61366
M61305	Each	24"	M61366
M61315	Each	30"	M61366

Medium Hair Floor Brush :

- 100% Selected black tampico bristles
- Staple set in clear lacquered half round hardwood block
- For sweeping semi-smooth floors
- 3" thick bristles
- **Does not include handle**

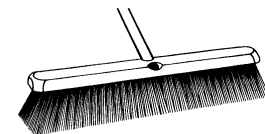

Item #	U/M	Size	Use Handle
M61278	Each	14"	M61366
M61284	Each	16"	M61366
M61293	Each	18"	M61366
M61314	Each	24"	M61366
M61320	Each	36"	M61366



MILL SUPPLY CO., INC.

Phone (410) 485-3343
Fax (410) 325-2240

Toll Free 1-800-817-8183

Janitorial

BRUSHES & BRUSH HANDLES

Garage Brush :

- Made of stiff palmyra fiber
- Staple set in clear lacquered streamlined hardwood block
- For wet or dry sweeping under rough conditions
- 4" thick bristles
- **Does not include handle**

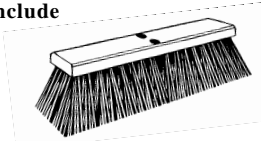

Item #	U/M	Size	Use Handle
M61290	Each	16"	M61362
M61299	Each	18"	M61362
M61311	Each	24"	M61362

Street Brush :

- Heavy gauge plastic bristles
- Will not absorb odors
- Durable, will outlast natural fiber bristles
- 16" wide block
- OSHA orange colored bristles are highly visible
- 4-1/4" thick bristles
- **Does not include handle**

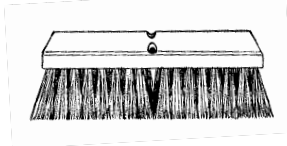

Item # M61283

U/M - Each

-Use Handle #M61358

Deck Brush :

- Stiff palmyra fiber
- Used for general purpose cleaning and cleaning of decks
- 2" thick bristles
- With two holes, it can accept either a threaded or a tapered handle
- 10" wide block
- **Does not include handle**

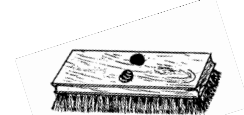

Item # M61655

U/M - Each

-Use Handle #M61366, #M61354 or #M61358

Roofers Brush :

- White tampico fiber
- Staple set in smooth sanded wax tumbled hardwood block with a tapered handle hole
- 2-1/2" thick bristles
- Used for applying roof cement, roof coating, stucco and mastic
- **Does not include handle**

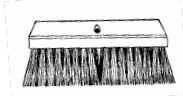

Item # M61675

U/M - Each

-Use Handle #M61354 or #M61358

Washing Brush :

- Used for washing cement mixers, mobile homes, boats, etc.
- Acid resistant 2-1/2" green bristles
- Our #M61592 brush has a protective rubber bumper surrounding the block to protect valuable surfaces
- 10" wide plastic block
- **Does not include handle**



Item #	U/M	Use Handle
M61637	Each	M61366
M61592	Each	M61366

Metal Braces :

- Replaces damaged handle braces
- Adds stability to broom and handle
- Helps prevent handle breakage
- Includes all hardware

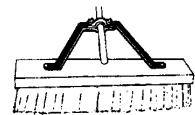

Item # M61399

U/M - Each

Item # M61402

U/M - Set

Tapered Wood Handle :

- Made of #1 straight grain hardwood
- Smoothly sanded with one end rounded and one end tapered
- 1-1/8" diameter

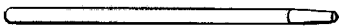

Item #	U/M	Length
M61354	Each	4-1/2'
M61358	Each	5'

Threaded Wood Handle :

- Selected hardwood with lacquered finish
- Crimped-on metal thread tip
- 5 foot long handle



Item #	U/M	Diameter
M61366	Each	15/16"
M61362	Each	1-1/8"

Steel Threaded Handle :

- All steel handle for superior strength
- Baked enamel finish provides protection against corrosion
- One piece construction
- 5 foot long handle



Item # M61375

U/M - Each



MILL SUPPLY CO., INC.

Phone (410) 485-3343

Fax (410) 325-2240

Toll Free 1-800-817-8183

Janitorial

BRUSHES & DUST PANS

Short Handle Fender Brush :

- Filling material is staple set in high-tensile strength foam plastic block
- Will not absorb water
- Recommended for use where sanitation is required
- Acid proof
- 8" long handle

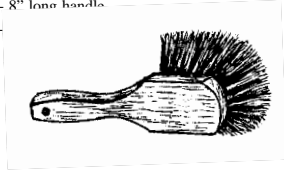

Item # M61614
U/M - Each

Long Handle Fender Brush :

- Filling material is staple set in wax tumbled hardwood block with hang-up hole in handle
- White tampico bristles
- 20" long handle
- 2" thick bristles

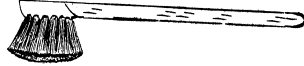

Item # M61618
U/M - Each

Nail Brush :

- Staple set in smooth sanded and waxed hardwood block
- White tampico bristles
- Excellent for cleaning dirt and grime out of hands and nails
- Brush size : 4-3/4"L x 1-1/2"W
- 5/8" thick bristles



Item # M61649
U/M - Each

Masonry Brush :

- Solvent resistant polypropylene
- 6-3/4" Hardwood handle
- 3-1/2" Bristles

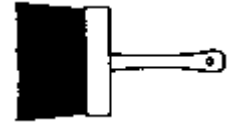

Item # M21598
U/M - Each

Pointed Scrub Brush :

- Filling material is staple set in a smooth wax tumbled hardwood block
- Block size : 10"L x 2-1/4"W
- White tampico bristles
- Bristles are 1" thick



Item # M61554
U/M - Each

Poly Scrub Brush :

- Natural and synthetic fibers set in plastic blocks
- Designed to make easy work of scrubbing tile, floors, baseboards, walls, countertops, etc.
- Iron style handle
- Overall length 6"

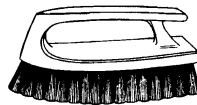

Item # M61660
U/M - Each

Dust Pan Brush :

- Tampico fiber
- Securely staple set in clear lacquered hardwood block
- Overall length 13-1/2"
- Bristles are 2" thick



Item # M61681
U/M - Each

Plastic Dust Pan :



- Deeper collection area to help avoid spillage
- Strategically placed teeth that make counter duster cleaning a snap
- Ergonomic handle and grip design including a thumb rest

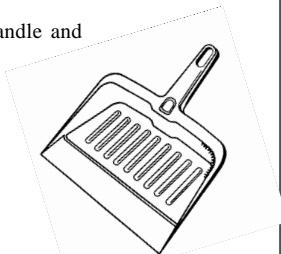

Item # M61233
U/M - Each

Metal Dust Pan :

- Black metal janitor dust pan in 20 gauge steel
- Baked enamel finish is durable with beveled edge
- Corrugated ribs add to strength

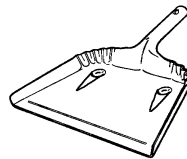

Item # M61234
U/M - Each

Lobby Dust Pan :



- Thinner lip for improved pick up
- Counterweighted to automatically shift to an upright position when lifted, helping to avoid spills
- 33" wood handle
- Easy to assemble, no tools required

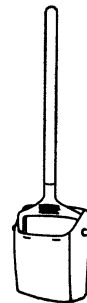

Item # M61229
U/M - Each



MILL SUPPLY CO., INC.

Phone (410) 485-3343
Fax (410) 325-2240

Toll Free 1-800-817-8183

Janitorial

CLEANING SUPPLIES

Metal Dust Pan w/Lid :

- Heavy duty metal dust pan with a self closing lid
- Keeps debris from escaping pan
- Includes a hanging hook on the handle
- 12" wide
- 9" deep
- 3" high
- 28" chrome handle

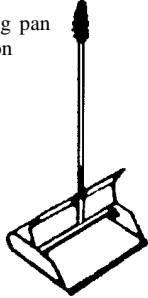

Item # M61241
U/M - Each

Metal Dust Pan :

- Heavy duty metal dust pan
- Thin lip for improved pick-up
- 14" wide
- 6" high
- 9" deep
- 28" wood handle

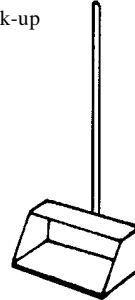

Item # M61244
U/M - Each

Feather Duster :

- Feathers are treated to attract and hold dust
- Soft enough for delicate dusting
- Hang hole for storage



Item # M61696
U/M - Each

Toilet Bowl Brush :

- Filling material is set in twisted wire
- White tampico bristles
- Set in plastic handle
- Brush head size 4" x 5"
- Overall length 16"



Item # M61575
U/M - Each

Wax Applicator :

- Two piece clear lacquered hardwood block
- Plated bolts and wing nuts
- Pad is made of synthetic lambswool
- Spreads wax uniformly
- Includes 48" wood handle and 1 pad
- Replacement pads are sold separately

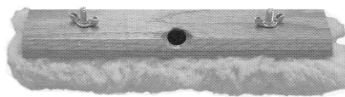

Item #	U/M	Size	Rep. Pad #
M61179	Each	12"	M61189
M61183	Each	16"	M61193

Sponge Squeegee :

- Rubber blade
- For use on windows, auto glass, tile, mirrors, wallpaper, shower doors, etc.
- 8" sponge / blade
- 12" wood handle



Item # M61212
U/M - Each

Window Squeegee :

- Rubber blades, not plastic
- Steel handle
- For use on windows, auto glass, tile, mirrors, wallpapering, shower doors, etc.



Item #	U/M	Width
M61202	Each	6"
M61204	Each	8"
M61210	Each	10"
M61214	Each	12"
M61216	Each	16"

Floor Squeegee :

- Industrial quality
- Oil and grease resistant
- Steel scraper head
- For use in industrial sites, garages, docks, etc.
- Does not include handle
- Uses handle #M61362



Item #	U/M	Width
M61218	Each	18"
M61220	Each	24"
M61222	Each	30"

Scouring Pad :

- Green
- 6" x 9"
- Heavy duty
- For tough kitchen cleaning



Item # M61708
U/M - Each

Box Qty.
10/ea



MILL SUPPLY CO., INC.

Phone (410) 485-3343
Fax (410) 325-2240

Toll Free 1-800-817-8183

Janitorial

CLEANING SUPPLIES

Scrub Sponge :

- Two sided sponge for fast, effective scouring power
- Removes tough, burned on food better than any other scrub sponge
- 4-1/2" x 2-1/2" x 1/2" thick



Item # M61736
U/M - Each

Commercial Sponge :



- Long lasting extra large size for jobs that require super absorbency and strength

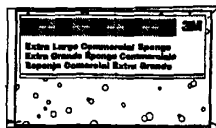

Item #	U/M	Size(LxWxH)
M61716	Each	6" x 3.3" x 1"
M61724	Each	6" x 4.2" x 1.6"
M61730	Each	7.5" x 4.3" x 2"

Sponge Mop :

- Lever wringing
- Scrubber strip removes tough dirt
- Safe for no wax floors



Item # M61040
U/M - Each

Lay Flat Mop :

- 20oz, 4 ply cotton head
- Narrow headband cut-end mop lies flat on floor
- "Screw-on" attachment makes changes quick and easy



Item # M61114
U/M - Each

Lay Flat Mop Handle :

- Wood handle with metal tip for superior strength
- 60" handle
- Fits our #M61114 mop



Item # M61124
U/M - Each

Sponge Mop Refill :

- Refill for our #M61040 sponge mop
- Scrubber strip removes tough dirt
- Safe for no wax floors
- Easy to attach, no tools required



Item # M61045
U/M - Each

Saddle Mop Head :

- Excellent absorption capacity which provides the best mop for floor drying, stripping and all purpose cleaning
- Wide bands
- End cut



Item #	U/M	Size
M61078	Each	12oz
M61081	Each	16oz
M61084	Each	20oz
M61087	Each	24oz
M61090	Each	32oz

Saddle Mop Handle :

- Quick-change type
- Heavy plated steel construction
- 1-1/8" #1 grade handle
- Wing nut construction with a channel-type cross bar that detaches from one side to allow quick change of mop head

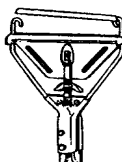

Item #	U/M	Size / Fits
M61098	Each	6" / 12-24oz
M61100	Each	7" / 20-32oz

Deck Mop :

- 4 ply absorbent white cotton yarn
- Head is a securely fastened to clear lacquered handle
- Head is covered with a plastic sleeve
- 16oz mop
- 54" wood handle



Item # M61066
U/M - Each



MILL SUPPLY CO., INC.

Phone (410) 485-3343
Fax (410) 325-2240

Toll Free 1-800-817-8183

Janitorial

CLEANING SUPPLIES

Swivel Dust Mop :

- Nylon Head
- 360 degree swivel
- Flexible frame



Item # M61164
U/M - Each



Dust Mop & Frame :

- 4 ply white absorbent cotton yarn
- Does not in... frame
- 24" wide

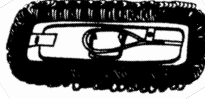

Item # M61158
U/M - Each

- Frame is made of heavy-duty metal
- Welded construction, plated finish
- 5" wide, 24" long
- Fits our #M61158 mop



Item # M61161
U/M - Each

Dust Mop Handle :

- For use with our dust mop and frame
- Plated metal connector
- 360 degree action
- Secured on a 1" diameter x 60" long clear lacquered handle

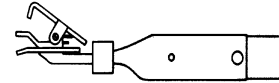

Item # M61171
U/M - Each

Mop Bucket w/Wringer :

- 26-35 quart capacity
- Extra deep sediment traps to bottom out dirt, separating it from the mop water
- Smooth operating sideward pressure wringer with corrosion resistant parts
- Yellow



Item # M61028
U/M - Each



Mop Bucket :

- 26-35 quart capacity
- Pour spout and hand grip make emptying fast and efficient
- Extra deep sediment traps to bottom out dirt, separating it from the mop water
- Yellow



Item # M61021
U/M - Each



Mop Wringer :

- Sideward pressure wringer
- Designed for maximum water evacuation
- Corrosion resistant parts
- For use with 12-32oz mop
- Yellow

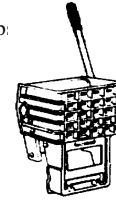

Item # M61019
U/M - Each



Galvanized Pail :

- 14 quart
- Durable, long lasting container
- Will not crack or leak



Item # M61014
U/M - Each

Utility Pail :

- 14 quart capacity
- High impact plastic construction
- Spout is molded for easy pours



Item # M61015
U/M - Each

Maid Cart :

- Combines the strength of steel with the durability of plastic
- Can easily carry a mop bucket with wringer on bottom shelf
- 4 bu. duck bag attaches and removes easily
- Maneuvers easy in tight places
- Approx. Size 28" L x 17" W x 39" H

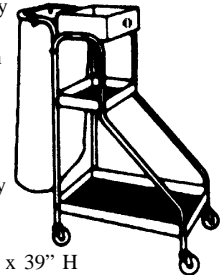

Item # M60596
U/M - Each



MILL SUPPLY CO., INC.

Phone (410) 485-3343
Fax (410) 325-2240

Toll Free 1-800-817-8183

Janitorial

CLEANING SUPPLIES

"Restroom Closed" Sign :

- Easel style
- 26" high
- 2 sided imprint english
- Yellow



Item # M61032
U/M - Each

"Wet Floor" Sign :

- Easel style
- 26" high
- 2 sided imprint english
- Yellow



Item # M61031
U/M - Each

Galvanized Trash Can :

- Galvanized sheet
- Includes lid



Item #	U/M	Capacity
M60804	Each	20 Gallon
M60807	Each	30 Gallon

Nifty Nabber :

- Gear driven claws grab bottles, cans and debris; overmolded "fingers" provide excellent gripping power - pick up cigarette butts and small objects with ease

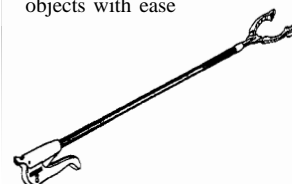

Item # M55701
U/M - Each

Trash Can :

- Heavy wall construction
- Molded handles
- Includes snap lock cover
- Green with black lid

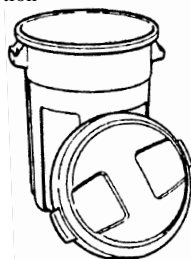

Item #	U/M	Capacity
M60828	Each	20 Gallon
M60834	Each	30 Gallon

Industrial Trash Can :

- Super-tough construction
- Molded in handles
- Fit tight lid
- 32 gallon capacity
- Includes lid
- Grey with grey lid

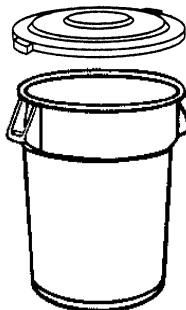

Item # M60840
U/M - Each

Trash Can w/Wheels :

- Heavy-duty construction
- Snap lock lid stays firmly in place
- 32 gallon capacity

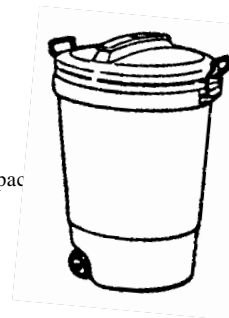

Item # M60843
U/M - Each

Wastebasket :

- Rim holds bags firmly in place
- Almond

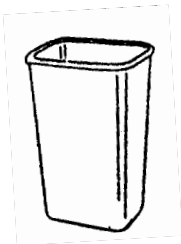

Item #	U/M	Capacity
M60878	Each	23 Qt / 5.75 Gal
M60880	Each	39 Qt / 9.5 Gal

Wastebasket w/Lid :

- Rim holds bags firmly in place
- White
- Self-closing dual action lid
- 52 Qt / 13 Gal capacity

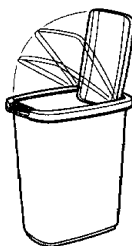

Item # M60855
U/M - Each

Trash Bags :

- Strong and durable
- Saves time and money in clean up costs
- Variety of sizes and weights to fit your specific applications
- Sold per case only



Item #	U/M	Bags	Mil	Size	Weight	Gallon
M60904	Case	1000/ea	.30	22.5"x24.5"	Light	7-10
M60908	Case	500/cs	.70	23"x33"	Heavy	12-16
M60912	Case	1000/ea	.30	23"x33"	Light	12-16
M60916	Case	250/ea	.37	30"x36"	Light	20-30
M60940	Case	250/ea	.37	33"x40"	Light	33
M60936	Case	1000/ea	.45	33"x40"	Med	33
M60952	Case	250/ea	.47	40"x46"	Med	40-50
M60944	Case	200/ea	.47	36"x58"	Med	55
M60956	Case	200/ea	.65	38"x58"	Heavy	60
M60960	Case	100/ea	1.2	38"x58"	X-HD	60
M60964	Case	50/ea	2.7	38"x63"	XX-HD	55-60



MILL SUPPLY CO., INC.

Phone (410) 485-3343
Fax (410) 325-2240

Toll Free 1-800-817-8183

Janitorial

CLEANING SUPPLIES

Single-Fold Towel

Cabinet :

- Dent resistant steel
- Self locking
- Holds 2 packages of single fold towels
- White enamel
- Includes key and mounting hardware

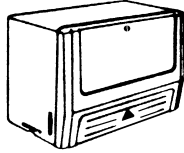

Item # M60721
U/M - Each

C-Fold & Multi-Fold

Towel Cabinet :

- Heavy gauge steel
- See thru gauge
- Hinged locking cabinet
- White enamel
- Includes key and mounting hardware

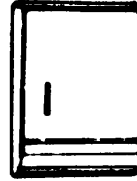

Item # M60723
U/M - Each

Hard Roll Towel

Dispenser :

- Dent resistant steel
- Delivers 1-7/8" per crank, accommodates 8" width up to 500' per roll
- Sloped design deters use for cigarettes
- Includes key and mounting hardware
- White enamel

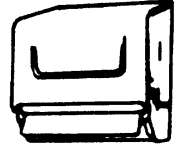

Item # M60725
U/M - Each

Single-Fold Towels :

- Ideal choice for high traffic areas in schools, plants, etc.
- Open drying surface
- 9.5"W x 10.62"L
- Natural color
- 16 packs per case
- 4,000 towels per case
- Sold per case only

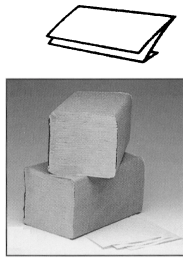

Item # M60105
U/M - Case

C-Fold Towels :

- Extra absorbency
- Reduces overall costs through low towel usage
- Low maintenance and high user acceptance
- Kleenex towels have extra absorbency pockets
- 2,400 towels per case
- Sold per case only

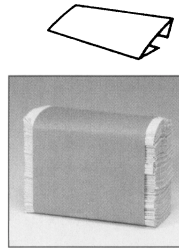

Item #	U/M	Size WxL	Brand
M60115	Case	10.25" x 13.25"	Generic
M60135	Case	10.4" x 13.3"	Kleenex®

Multi-Fold Towels :

- Soft, absorbant, embossed, quality folded towels
- White color
- 9.25"W x 9.5"L
- 16 packs per case
- 4,000 towels per case
- Sold per case only

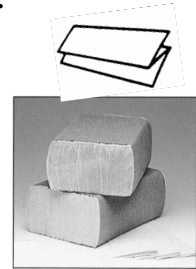

Item # M60110
U/M - Case

Hard Roll Towels :

- Soft, strong and absorbent
- Natural color
- 12 rolls per case
- Sold per case only

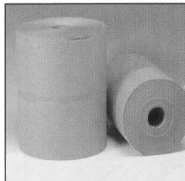

Item #	U/M	Size WxL
M60155	Case	8" x 350'
M60120	Case	7.87" x 625'

Household Roll Towel :

- Made from 100% recycled fiber content
- Offering, all-round versatility and providing superior performance
- 2 ply
- 9" x 11" sheets
- 85 sheets per roll
- 30 rolls per case
- Sold per case only



Item # M60165
U/M - Case

Household Roll Towel :

- Strong and absorbant
- Ideal for use in food service locations or in the home
- 2 ply
- 8.8" x 11" sheets
- 100 sheets per roll
- 30 rolls per case
- Sold per case only



Item # M60125
U/M - Case



MILL SUPPLY CO., INC.

Phone (410) 485-3343
Fax (410) 325-2240

Toll Free 1-800-817-8183

Janitorial

CLEANING SUPPLIES

Scott Surpass[®]

Household Roll Towel :

- Soft yet strong, hard-working paper towel that can tackle tough jobs
- Good quality white towel specially textured for absorption
- Each sheet tears neatly and cleanly
- Sheets are 11" x 9.17"
- 96/ea - 2 ply sheets per roll
- 30 rolls per case

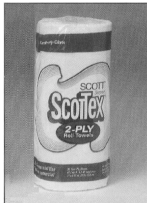

Item # M60145
U/M - Case

Medium Duty Wipers :

- Tough, long-lasting scrim reinforced wiper
- Cellulose fibers surround the reinforcement providing abrasion resistance and extra absorbency
- Effective on oil spills, auto repair jobs and general maintenance work
- White - 13" x 13" sheets
- 16 boxes of 50 wipes per case
- 800 wipes per case



Item # M60177
U/M - Case

Workhorse Wipes[®] :

- Made with hydroknit™ fast-absorbing material maximizing the wiping efficiency by absorbing liquids faster while maintaining its unique strength
- Textured to pick up stubborn dirt and grime
- White - 11.75" x 15" sheets
- 18 packs of 50 wipes per case
- 300 wipes per case

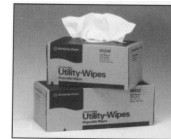

Item # M60185
U/M - Case

Scrubs In-A-Bucket[®] :

- Antibacterial, waterless hand cleaner towels
- Pre-moistened, heavy-duty towel with pumice scrubbing power
- Works fast to loosen, dissolve and absorb dirt and grease
- 10-1/2" x 12-1/4" towels
- 72 towels in dispenser bucket

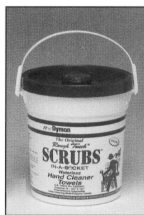

Item # M60190
U/M - Each

Scrubs Stainless Steel Cleaner[®] :

- Fast and efficient way to remove tarnish and oxidation without the mess and waste associated with traditional polishes
- Combines a non-scratching abrasive cloth, pre-moistened and premeasured with a low ammonia polishing formula containing no harsh abrasives and safe on all metals
- 18/ea - 8" x 11" scrubs per pack



Item # M60195
U/M - Each

Toilet Tissue :

- 2 ply
- Excellent combination of quality and economy
- Safe for use in septic systems
- 96 rolls per case
- Sold by the case only



Item #	U/M	Sheets / Roll	Brand
M60565	Case	500 Sheets	Generic [®]
M60250	Case	400 Sheets	Cottonelle [®]

JRT Toilet Tissue :

- Giant roll for less changes
- Reduces runout and maintenance costs
- One JRT roll equals 12 standard one-ply 1,000 sheet count rolls
- Scott Surpass[®]
- 12 rolls per case
- Sold per case only

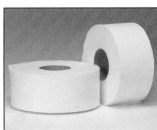

Item #	U/M	Ply	Size
M60255	Case	1 ply	3.78" x 2000'
M60560	Case	2 ply	3.78" x 1000'

Classic Roll Tissue Holder :

- Pilfer-proof locking device-brake spring action-18 ga. steel
- Conforms to Fed. Spec. WW-H-001911
- Bright chrome finish
- Single roll capacity

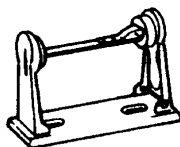

Item # M60711
U/M - Each

Rags :

- For a variety of cleaning and dusting uses
- Excellent quality
- Sold by the box only

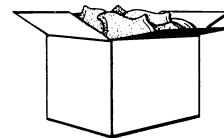

Item #	U/M	Size	Type
M60005	Box	10 lbs	Color T-Shirt
M60010	Box	10 lbs	Turkish
M60020	Box	10 lbs	White Turkish
M60030	Box	25 lbs	Color T-Shirt
M60040	Box	25 lbs	Turkish
M60050	Box	25 lbs	White T-Shirt
M60055	Box	25 lbs	White Turkish
M60060	Box	50 lbs	Turkish



MILL SUPPLY CO., INC.

Phone (410) 485-3343
Fax (410) 325-2240

Toll Free 1-800-817-8183

Janitorial

HOUSEWARES / VACUUM CLEANERS

Styrofoam Cups :

- Insulated foam cups preserve freshness and flavor
- Keeps hot drinks at their serving temperature, and keeps cold drinks chilled without sweating
- 8 oz cups
- 1,000 cups per case
- Sold per case only



Item # M60753
U/M - Case

Facial Tissue :

- 2 ply facial tissue
- The softest Kleene[®] ever
- Dispenser size
- Tissues toward the bottom are different color to alert you when time to change box
- 100 sheets per box
- 36 boxes per case
- Sold per case only



Item # M60607
U/M - Case

Mighty Mite[®] :

EUREKA[®]

- Lightweight compact design
- Built-in attachment storage
- Multi-task blower port
- Powerful 9.0 Amp. motor
- Large dust bag capacity
- Swivel hose
- 6 piece attachment set

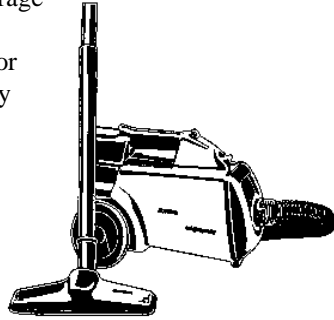

Replacement Dust Bags
for Mighty Mite[®]
Item # M69786
U/M - Pack
(3 Bags / Pack)

Item # M69707
U/M - Each

The Boss[®] :

EUREKA[®]

- Powerful 11 Amp. motor
- Dual edge cleaning
- 7 position carpet height adjustment
- Ergonomic handle
- Ready to use attachments
- Built in motor fan protection system
- Easy assembly



Replacement Dust Bags
for The Boss[®]
Item # M69782
U/M - Pack
(3 Bags / Pack)

Item # M69715
U/M - Each

Commercial Heavy Duty :

EUREKA[®]

- 7.0 Amp. maintenance free motor
- 8 position carpet height adjustment
- Chromed steel ball bearing beater bar brush roll
- 50' cord length

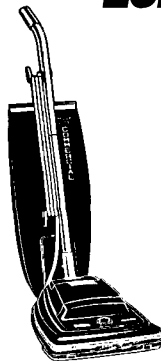

Replacement Dust Bags
for Commercial Vacuum
Item # M69779
U/M - Pack
(2 Bags / Pack)

Item # M69718
U/M - Each

Replacement Belts :

EUREKA[®]

- Replaces your old or damaged belts
- Sold per pack only



Item #	U/M	# Belts	Fits Our #
M69772	Pack	2	M69715
M69742	Pack	2	M69718



MILL SUPPLY CO., INC.

Phone (410) 485-3343
Fax (410) 325-2240

Toll Free 1-800-817-8183

Janitorial

VACUUM CLEANERS / FLOOR CLEANERS

6 Gallon Wet / Dry Vacuum :

- Industrial quality
- 2.5 H.P.
- Standard equipment includes: 7' x 1-1/4" hose, 1-1/4" diameter extension wands, 10" master nozzle, 10" squeegee shoe, 10" rug shoe, 10" brush shoe, 1-1/4" crevice tool, 6' x 2-1/2" hose, 2-1/2" extension wands and utility nozzle
- 18' cord



Item # M69504
U/M - Each

10 Gallon Wet / Dry Vacuum :

- Same standard equipment as 6 gallon unit
- Industrial quality
- 2.5 H.P.
- 18' cord
- Cross brace dollies for superior stability



Item # M69508
U/M - Each

Shop-Vac Accessories:

Paper Filter Bag :

- For fine dusts and powders (dry pick-up)
- Includes filter strap
- Disposable
- 5 bags per pack
- Sold per pack only



Item # M69531
U/M - Pack

Foam Sleeve :

- Secondary filter for wet pick-up
- Sold per each

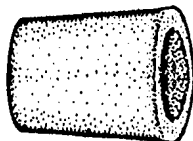

Item # M69555
U/M - Each

Cloth Filter Bag :

- Large debris and dry material pick-up
- Washable and reusable
- Super performance
- Economical



Item # M69559
U/M - Each

Crushproof Hose :

- 1-1/4" x 7'
- Airflow control
- Black

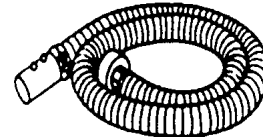

Item # M69562
U/M - Each

Sweeping Compound :

- Sanded oil base
- Manufactured with select kiln-dried softwood sawdust and quality waxes
- Does not contain any sand or grit and can not scratch or mar the surfaces of waxed floors
- Use on terrazzo, asphalt, rubber, cork and composition
- 100 lb. box



Item # M65043
U/M - Box

Absorbent :

- Multi-purpose absorbent holds large amounts of liquid spills without breakdown, mudding or caking
- Absorbs oil, grease, paint, food waste and other messy spills
- Low dust formulation, non-flammable
- 50 lb. bag

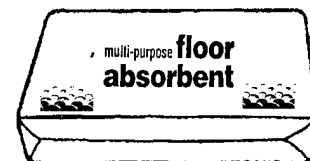

Item # M65029
U/M - Each



MILL SUPPLY CO., INC.

Phone (410) 485-3343
Fax (410) 325-2240

Toll Free 1-800-817-8183

Janitorial

Janitorial

FLOOR & CARPET CARE

Dynomite Mop And Strip :

- A balanced blend of solvents and detergents penetrates old finishes for fast and easy removal
- Non-ammoniated and pleasant to work with



Item #	U/M	Size
M65180	Each	1 Gallon
M65179	Each	5 Gallon

Topshine :

- Liquid floor finish that provides good performance in an easy to use product
- Withstands detergent scrubbing
- Resists spotting or dulling from tracked-in dirt or spills



Item #	U/M	Size
M65186	Each	1 Gallon
M65187	Each	5 Gallon

Carpet Shampoo :

- Super concentrated dry foam shampoo that contains special soil barriers to protect against future resoiling
- Fast drying and low wetting to provide the most efficient operation
- 1 gallon container



Item # M66047
U/M - Each

Carpet Spotter :

- This versatile formulation mixes special emulsifiers and solvents to provide a very effective and powerful carpet spotter that removes most stains
- 1 gallon container



Item # M66041
U/M - Each

Dynasteam :

- This formula combines sequestering agents, defoamers, optical brighteners and deodorants to knock out dirt and restore carpet to its original beauty and brightness
- Helps prevent musty odors and leaves no film
- 1 gallon container



Item # M66038
U/M - Each

Resolve[®] :

- Cleans tough spots and stains
- Contains a unique cleaning and protective formula to help repel stains and make carpet cleaning easier
- Safe on wool, nylon and stain-resistant carpet
- 22 oz spray



Item # M66028
U/M - Each

Mop & Glow[®] :

- Leaves a high gloss durable shine on both regular and "no-wax" floors
- Seals out dirt
- Cleans and shines as you damp mop
- Squeeze bottle
- 32 oz container



Item # M65231
U/M - Each

Carpet Deodorizer :

- Eliminates carpet and room odors
- Leaves the entire room refreshed with the natural fragrances of potpourri
- Can be used on upholstery
- 24 oz container



Item # M66004
U/M - Each

Love My Carpet[®] :

- Neutralizes odors, does not cover them up
- New improved formula
- Safe for all carpets and safe around pets
- Can be used on upholstery
- 21.3 oz container



Item # M66012
U/M - Each



MILL SUPPLY CO., INC.

Phone (410) 485-3343
Fax (410) 325-2240

Toll Free 1-800-817-8183

Janitorial

DEODORIZERS / CLEANERS

Water Soluble Deodorant :

- For industrial and institutional use
- Ideal for use on carpet or upholstery
- Removes odors associated with pets, food, mustiness, vomit, smoke, etc.
- Fresh lemon scent
- 1 gallon container

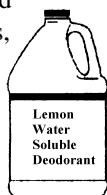

Item # M65275
U/M - Each

Eliminate :

- An original malodor counter-actant and deodorizing agent that neutralizes and dissolves menacing odors rather than masking them
- Removes odors from carpets, dumpsters and areas where odors linger
- 1 gallon container



Item # M66144
U/M - Each

Dual Odor Eliminator :

- For professional & institutional use in removing odors caused by: smoke, pets, bathroom, garbage areas, etc.
- Can be used as a total release or handheld aerosol to be sprayed as needed
- 5 oz can



Item # M65508
U/M - Each

Dynasept Pine :

- A concentrated quaternary ammonium disinfectant cleaner that provides disinfecting and cleaning while leaving behind a pleasant pine fragrance
- Safe for all surfaces not harmed by water
- 1 gallon container



Item # M65435
U/M - Each

Lysol[®] :

- Antibacterial disinfectant
- Kills 99.9% of germs in seconds
- Eliminates odors
- Kills viruses, bacterial, mold and mildew
- Original scent
- 12 oz can



Item # M65216
U/M - Each

Glade[®] :

- Designed specifically to neutralize tough problem odors
- Use anywhere tough odors are a problem
- Leaves a clean, fresh scent
- 13 oz can



Item # M65502
U/M - Each

Kleen Mist[®] :

- Effective odor neutralizer without heavy fragrances
- Ideal in home or commercial
- For use in automatic dispenser but can be used without it
- Leaves no residue
- 7 oz can



Item #	U/M	Fragrance
M65512	Each	Garden Apple
M65513	Each	Cinnamon
M65514	Each	Lemon
M65515	Each	Floral

Deluxe Automatic Aerosol Dispenser :

- Real time clock
- 1-60 minute spray interval
- Programmable start & stop
- Weekend selection
- LED indicator
- Refill reminder
- Fits all metered aerosols
- Key or keyless lock

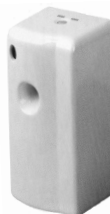

Item # M65522
U/M - Each

Bleach :

- Excellent for cleaning tile, linoleum, bathtubs, sinks, etc.
- In wash use for bleaching colored fabrics
- 1 gallon container



Item # M65562
U/M - Each



MILL SUPPLY CO., INC.

Phone (410) 485-3343
Fax (410) 325-2240

Toll Free 1-800-817-8183

Janitorial

ALL PURPOSE CLEANERS

Ammonia :

- Excellent for general cleaning of: appliances, floors, surfaces, pots, pans, ovens, broilers, etc.
- Very good for use on: outdoor grills and other heavily soiled areas such as ovens or stove tops
- 1 quart container



Item # M65277
U/M - Each

Ajax :[®]

- Special ammoniated heavy duty cleaning formula
- Concentrate formula
- No rinsing required
- Use on: floors, walls, woodwork, venetian blinds, porcelain and enamel, etc.



Item #	U/M	Size
M65279	Each	28oz.
M65278	Each	1 Gallon

No-Rinse Detergent :

- A concentrated, non-dulling, neutral cleaner that will not soften floor finish
- Leaves no residue
- All purpose cleaner that can be used on all surfaces
- Leaves a lemon scent
- 1 gallon container



Item # M66163
U/M - Each

Pine Odor Cleaner :

- Highly concentrated all purpose cleaner with strong pine odor is diluted at 1-1/2 to 2-1/4 ounces per gallon
- For those who want or need the power of pine
- Can be used in hot or cold water



Item #	U/M	Size
M65421	Each	1 Gallon
M65425	Each	5 Gallon

Pine-Sol :[®]

- Removes tough grease and dirt
- Kills household germs
- Deodorizes with a fresh clean scent
- Excellent for: floors, counters, sinks, stoves, showers, toilets bowls, garbage cans, etc.
- 28 oz container



Item # M65269
U/M - Each

Dynamint :

- General purpose cleaner that suspends dirt for fast and easy removal
- Leaves a fresh mint fragrance
- Can be used on all washable surfaces



Item #	U/M	Size
M66099	Each	1 Gallon
M66094	Each	5 Gallon

Fantastic :[®]

- Professional formula
- Cleans most washable surfaces
- Removes stubborn soils like; grease, crayon marks, pencil marks, fingerprints, smoke film, scuff marks, etc.
- Can be applied with sponge, sprayer, mop or brush
- 32 oz spray



Item # M65083
U/M - Each

Spray Nine :[®]

- Multi-purpose germicidal cleaner
- Harmless to most surfaces
- Kills Staph, Pseudomonas, Salmonella and many other common bacteria on contact
- Also controls odors and mildew
- 24 oz spray



Item # M65104
U/M - Each

409 :[®]

- All purpose cleaner
- Kills 99.9% of bacteria
- Powers through grease and grime
- Dissolves soap scum on contact
- Contains no phosphates
- 32 oz spray



Item # M65056
U/M - Each



MILL SUPPLY CO., INC.

Phone (410) 485-3343
Fax (410) 325-2240

Toll Free 1-800-817-8183

Janitorial

JOB SPECIFIC CLEANERS

Goo Gone[®]

- Quickly and easily removes many hard to remove stains
- All purpose cleaner
- Works on carpets too
- Indoor and outdoor use
- Citrus power and scientific technology combine to solve your most difficult cleaning problems
- 24 oz spray



Item # M66173
U/M - Each

Afta[®]

- Professional strength cleaner, degreaser, and adhesive remover
- For use on cloths, carpets, upholstery, draperies, auto interiors, machine parts, typewriter type tools, marble and glass
- 32 oz container



Item # M66036
U/M - Each

Lysol[®]

- Deodorizing all purpose cleaner
- Country scent
- Cuts grease and disinfects
- Cleans regular and no wax floors, cabinets, sinks, tubs, tile, garbage cans and pet areas
- Kills bacteria
- 35 oz container



Item # M65220
U/M - Each

Spic & Span[®]

- For stoves, refrigerators, countertops, walls, woodwork and tough floor cleaning problems
- Removes film, spots and grease from all modern surfaces
- 27 oz container



Item # M65167
U/M - Each

Murphy Oil Soap[®]

- Beautifully cleans wood and laminate surfaces
- Leaves no dulling residue
- Excellent for; wood floors, cabinets, tables, chairs, paneling, bookcases, etc.
- 32 oz container



Item # M65122
U/M - Each

Dirtex[®]

- Extra-strength for windows, mirrors, porcelain, tile and chrome
- Removes dirt, grease, and grime
- Restores a brilliant shine to kitchens and bathrooms
- 18 oz spray



Item # M65119
U/M - Each

Easy-Off[®]

- Available in regular and fume free
- Cuts through tough baked in food and grease
- Cleans warm or cold ovens, broilers, stainless steel surfaces and barbecue grills
- 16 oz spray



Item #	U/M	Type
M65333	Each	Regular
M65331	Each	Fume Free

Oven Cleaner :

- Deep penetrating formula that cuts baked-on grease and carbon
- For use on ovens, grills, friers, and hoods
- No bothersome fumes
- USDA authorized
- 1 gallon container



Item # M65339
U/M - Each



MILL SUPPLY CO., INC.

Phone (410) 485-3343
Fax (410) 325-2240

Toll Free 1-800-817-8183

Janitorial

JOB SPECIFIC CLEANERS

PDQ[®]:

- Fast acting, butyl-based degreaser / cleaner
- Saves time, energy, and money
- Ideal for cleaning most surfaces, including floors, woodwork, countertops, and painted surfaces
- USDA authorized



Item #	U/M	Size
M65473	Each	1 Gallon
M65476	Each	5 Gallon

Soft Scrub[®]:

- Tough on dirt without harsh scratching
- Tough on soap scum
- Excellent on tubs, tiles, sinks, stovetops, toilets, and countertops
- Soft scrub with bleach is antibacterial
- 26 oz container



Item #	U/M	Type
M65188	Each	Regular
M65190	Each	w/Bleach

Zud[®]:

- Heavy-duty cleanser
- Removes rust and stains
- For use on tubs, sinks, floor tile, range hoods, stove tops, etc.
- 16 oz container



Item # M65296
U/M - Each

Comet[®]:

- Disinfectant cleanser with clorinol[®]
- Use on greasy food stains, dirt, soap scum, tough mildew, etc.
- No scratch formula contains no harsh abrasives
- 21 oz container



Item # M65249
U/M - Each

Bab-O[®]:

- Fast acting
- Bleaches stains away
- Contains no harsh abrasives
- Many uses both in kitchen and bathroom
- Leaves fresh, clean scent
- 21 oz container



Item # M65254
U/M - Each

Tilex[®]:

- Mildew remover
- Disinfects and kills mildew
- Lemon fresh
- Use around tile, grout, toilets, and outdoor areas
- 16 oz spray



Item # M65131
U/M - Each

X-14[®]:

- **Instant mildew stain remover**
- Maximum strength
- Removes tough stains without scrubbing
- Can also be used for preparing surfaces for painting
- 16 oz container



Item # M66056
U/M - Each

X-14[®]:

- **Soap scum remover**
- New herbal scent
- Removes tough soap scum, dirt, water spots, and other bathroom stains without scrubbing
- 32 oz container



Item # M66052
U/M - Each

Lysol[®]:

- Basin tub & tile cleaner
- Foaming action
- Cleans, shines and disinfects washable bathroom surfaces and fixtures
- Does not harm most bathroom surfaces
- No CFC's
- 17 oz spray



Item # M66069
U/M - Each



MILL SUPPLY CO., INC.

Phone (410) 485-3343
Fax (410) 325-2240

Toll Free 1-800-817-8183

Janitorial

CLEANING SUPPLIES

Automatic Bowl Cleaner :

- Just place inside tank and forget it
- Helps clean bowl with every flush
- Safe for septic tanks
- Leaves bowl sparkling blue
- No mess installation



Item # M66122
U/M - Each

Dynabol :

- Hydrochloric acid, powerfully effective emulsion bowl cleaner and disinfectant that quickly penetrates, lifts and inhibits the return of soil, algae, rust stains, uric acid, hard to remove stains etc.
- EPA registered
- 1 gallon container

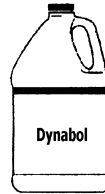

Item # M66132
U/M - Each

Low Acid Bowl & Tile :

- Hydrochloric acid-based disinfectant cleaner that combines detergents and wetting agents to remove tough stains, including rust and lime
- EPA registered
- 1 gallon container



Item # M66135
U/M - Each

Natural Beauty :

- Alkaline based formulation proves very effective on any bathroom surface-even stainless steel
- Varying dilution ratios makes this product highly versatile for numerous situations
- 1 gallon container



Item # M66142
U/M - Each

Urinal Block :

- Unaffected by running water
- Will not chip, flake or crack
- 100% paradichlorobenzene with special perfume oils
- Individually wrapped to maintain freshness and shelf life
- 2-1/2" diameter x 1" thick



Item # M66104
U/M - Each

Wall Block :

- Same powerful chemicals contained in our urinal block
- Can be place behind or near malodors
- Special container allows it to be hung-up
- 2-1/4" W x 2" H x 6-3/4" L

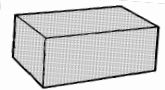

Item # M66114
U/M - Each

Soap Pads :

- Hotel size
- Specifically designed for cleaning of institutional and restaurant kitchen equipment
- Special combination of soap and metal fiber dissolves sticky food and grease quickly
- 4" x 4" pads
- 10 pads per box



Item # M66256
U/M - Box

Tide :[®]

- Laundry detergent
- Gets out tough institutional dirt and many stains that other detergents leave behind
- Power form
- Economy size
- 36 lb box



Item # M65618
U/M - Box

Cascade :[®]

- Automatic dishwashing detergent
- Leaves virtually spotless dishes
- Formulated to tackle tough dishwashing conditions
- Powder form
- 35 oz box



Item # M65625
U/M - Box



MILL SUPPLY CO., INC.

Phone (410) 485-3343
Fax (410) 325-2240

Toll Free 1-800-817-8183

Janitorial

CLEANING SUPPLIES

Windex :[®]

- Professional strength
- Glass cleaner with ammonia
- Powerized formula
- Cleans without leaving streaks
- Contains no phosphates
- 20 oz spray



Item # M65656
U/M - Each

Windex :[®]

- Professional strength
- Glass cleaner with ammonia
- Powerized formula
- Cleans without leaving streaks
- Contains no phosphates
- 1 gallon container



Item # M65668
U/M - Each

Glass Plus :[®]

- Professional strength
- Cleans glass plus a whole lot more
- Cleans without streaking
- Contains no phosphates
- 32 oz spray



Item # M65662
U/M - Each

Spray Bottle :

- Adjustable nozzle goes from spray to stream
- Can be filled with many types of cleaners
- 22 oz capacity plastic container



Item # M66276
U/M - Each

Window Cleaner :

- An alcohol and detergent formula for streak-free windows, mirrors, and glass
- This concentrated product is also ideal as a dual purpose surface cleaner
- 1 gallon container



Item # M65678
U/M - Each

Pledge :[®]

- Lemon scent
- Picks up dust, shines and helps protect against ordinary wear, water spills and stains
- Removes fingerprints, smudges and dirt
- No-wax formula
- Conditions wood while you dust
- 12.5 oz spray



Item # M65583
U/M - Each

Endust :[®]

- Professional formula
- No-wax cleaning and dusting spray
- Cleaning and dusting in one easy step
- No residue build-up
- Fresh scent
- 16 oz spray



Item # M65591
U/M - Each

Old English :[®]

- For polishing and cleaning use Oil English oil
- For covering unsightly scratches in wood surfaces, use Old English scratch cover.
- Scratch cover is available for both light and dark woods
- Oil - 16 oz container
- Scratch cover - 8 oz container



Item #	U/M	Type
M65595	Each	Oil - For all woods
M65599	Each	Scratch Cover - Dark
M65603	Each	Scratch Cover - Light



MILL SUPPLY CO., INC.

Phone (410) 485-3343
Fax (410) 325-2240

Toll Free 1-800-817-8183



Automotive

Automotive



MILL SUPPLY CO., INC.

Phone (410) 485-3343
Fax (410) 325-2240

Toll Free 1-800-817-8183

Automotive

HAND CLEANERS / VANDAL REMOVERS

Ivory Soap :[®]

- Mild, natural soap has no synthetics nor heavy perfumes
- 99% pure
- It offers twice the lather of other brands with outstanding cleaning performance
- 3.1 oz



Item # M66205
U/M - Each

Lava Soap :[®]

- Outstanding cleaning performance
- Pumice helps power dirt and grease away
- Cleans dirt better than bar soaps
- 4 oz

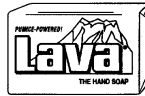

Item # M66210
U/M - Each

Boraxo :[®]

- Select blend of quality soap and borax
- Gentle to your hands, yet scrubs out deepest grime
- Soluble, won't clog drains or harm fixtures
- 5 lb box



Item # M66222
U/M - Each

GoJo :[®]

- Petroleum free
- Citrus formula with pumice to deep clean
- Contains lanolin, aloe, and jojoba to help protect hands
- 1 gallon container with pump



Item # M65703
U/M - Each

Lan-Lin :[®]

- Fortified with lanolin
- Cleans the toughest grease, oil, and grime
- Use with or without water
- **Pump dispenser** is for use with 4-1/2 lb cleaner and includes all hardware



Item #	U/M	Size / Type
M65705	Each	14 oz Cleaner
M65709	Each	4-1/2 lb Cleaner
M60734	Each	Dispenser for 4-1/2 lb

Hand Soap :

- **Pink lotion** is a soothing blend of cold cream and lanolin in an effective honey-almond soap
- **Coconut** is an economical, coconut based soap
- 1 gallon container



Item #	U/M	Type
M65711	Each	Pink Lotion
M65720	Each	Coconut

Soap Dispenser :

- Gravity feed w/replaceable metal valve and plastic globe
- Holds 16 oz
- Chrome
- Includes all mounting hardware

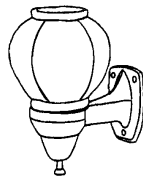

Item #	U/M	Type
M60732	Each	Dispenser
M60733	Each	Globe - only

Goof Off :[®]

- Quickly and easily removes old dried latex paint, caulk, most glues, marker and pen ink, crayons, tar, lipstick, chewing gum, oil, grease, scuff marks, candle wax, printer inks, and more
- 16 oz container



Item # M66166
U/M - Each

Vandal Spray :

- Unique jelled formula will not run off
- Removes spray paint, crayons, lipstick, permanent marker, masking tape, and inks
- Use on porous and non-porous surfaces
- Use on signs, walls, bridges, lockers, public telephones, subways, trains, and buses



Item # M66169
U/M - Each



MILL SUPPLY CO., INC.

Phone (410) 485-3343
Fax (410) 325-2240

Toll Free 1-800-817-8183

Automotive

DEGREASERS / LUBRICANTS

Grez-Off[®]

- Cuts heavy grease and soil quickly on engines, mowers, tools, bicycles, garden and farm equipment
- Biodegradable
- Non-flammable
- 25 oz spray



Item # M65115
U/M - Each

Surge :

- Works fast against oil, grease, asphalt, soils, and other petroleum derived grime
- Can be used in pressure washers and other applicators
- 1 gallon container



Item #	U/M	Size
M65496	Each	1 Gallon
M65499	Each	5 Gallon

Silicone Spray :

- Stops squeaks
- Repels water
- Reduces friction and sticking
- Keeps rubber soft and flexible
- 10 oz spray



Item # M63367
U/M - Each

PB Blaster[®]

- Frees rusted bolts and nuts
- Stops rust and corrosion
- Ends squeaking problems
- Fast penetrating action acts quickly to absorb into problem areas
- Does not evaporate
- 12 oz spray



Item # M65830
U/M - Each

WD-40[®]

- Loosens rusted parts
- Displaces moisture
- Stops squeaks
- Protects metal
- Cleans grease, grime, tar, adhesives, gum, crayon, and more
- Aerosol spray



Item #	U/M	Size
M65836	Each	2 oz
M65839	Each	11 oz

Liquid Wrench[®]

- Super penetrant
- Frees rusted bolts and parts
- Deodorized, leaves no foul odor
- Contains no CFC's



Item #	U/M	Size / Type
M65860	Each	4 oz / Applicator
M65862	Each	11 oz / Spray

Multi-Purpose Oil :

- Lubricates, cleans, and prevents rust
- Easy applicator puts oil where you want it



Item #	U/M	Size
M65821	Each	3 oz
M65825	Each	8 oz

Motor Oil :

- Heavy-duty
- Meets new car warranty
- Keeps engine clean and quiet
- 1 quart container
- *M64020 is a non-detergent oil



Item #	U/M	Weight
M64020	Each	SAE30
M64025	Each	10W 30
M64033	Each	10W 40

Two Cycle Oil :

- Designed to extend spark plug life, minimize wear, control rust and corrosion in fresh and salt water conditions
- For outboard and two cycle applications



Item #	U/M	Size
M64015	Each	8 oz
M64013	Each	1 Quart



Automotive

METAL CLEANERS / GAS CANS

Noxon[®]

- Metal polish
- Use on stainless steel, aluminum, chrome, pewter, brass, bronze, and copper
- Easy to use
- Thick formula
- 12 oz container



Item # M65911
U/M - Each

Stainless Steel Cleaner :

- Economy size
- Extra strength
- Polishes and cleans in one easy step
- For use on stainless steel, chrome, formica, and porcelain
- Leaves protective coating
- 16 oz spray



Item # M65923
U/M - Each

Brasso[®]

- Cleans, polishes, and protects brass, copper, stainless steel, and pewter
- Will not scratch fine metals
- Leaves a smooth, polished surface and a brilliant shine
- 1 gallon container



Item # M65934
U/M - Each

Gasoline Can :

- Made of corrosion resistant high density heavy gauge polyethylene
- In-spout filter-flame arrestor
- New spout compatible with no lead gas nozzle
- 5 gallon capacity
- Red

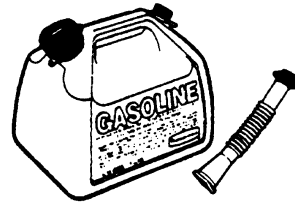

Item # M12003
U/M - Each

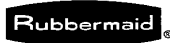

Safety Can :

- For storage of gasoline and flammable liquids
- Made of 24 gauge galvanized steel
- Meets OSHA requirements
- Non-sparking pour spout and screen
- Equipped with brass flame arrestor

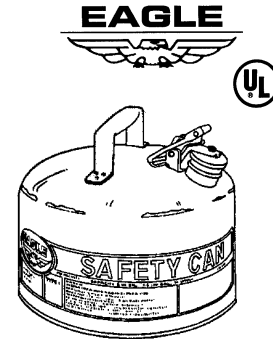

Item #	U/M	Capacity / Color
M12011	Each	2.5 gal / Red
M12015	Each	5 gal / Red
M12027	Each	5 gal / Yellow

Funnel :

- Made of tough, high-density polyethylene
- May be used with multiple substances such as oil, radiator, fluid or fuel additives
- 2qt. capacity

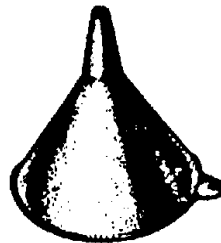

Item # M12076
U/M - Each

Funnel :

- For use with our steel safety cans
- Made of high density polyethylene
- Funnel is 9" long with the smaller end having a 7/8" I.D. and 1-1/8" O.D.
- Yellow

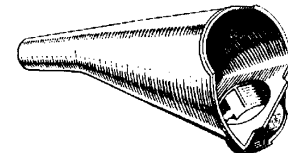

Item # M12079
U/M - Each



MILL SUPPLY CO., INC.

Phone (410) 485-3343
Fax (410) 325-2240

Toll Free 1-800-817-8183

Automotive

AUTOMOTIVE

Pump Oiler :

- 2 pint blue poly body
- Zinc plated detachable, flexible spout
- Hydraulic pump

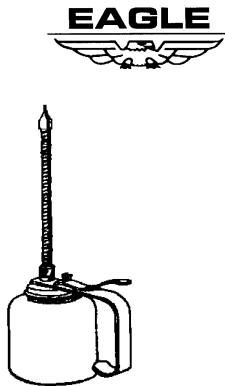

Item # M12048
U/M - Each

Grease Gun :

- Constructed of heavy duty steel and finished in rugged baked enamel and tough zinc plate
- Easy cartridge loading and complete grease discharge
- 6" extension and coupler
- Two-way loading cartridge or suction



Item # M65870
U/M - Each

Lithium Grease :

- Multi-purpose grease; ideal for automotive, agricultural, and industrial applications
- Heavy duty lithium grease resists heat, repels water, and prevents wear
- Ideal for heavy duty applications for around the home, farm or shop



Item #	U/M	Type	Size
M65872	Each	Multi-purpose	14 oz.
M65871	Each	Heavy duty	14 oz.

Windshield Washer :

- Year round formula to zero degrees
- 1 Gallon container



Item # M64064
U/M - Each

Ice Scraper/Snow Brush:

- Durable 7" Brush and 3-3/4" acrylic blade
- Built in finger grip



Item # M64076
U/M - Each

Antifreeze :

- Provides a high degree of performance durability and carefully balanced protection against corrosion of all cooling system metals, including aluminum.
- For use in heavy duty and/or automotive engines



Item # M64056
U/M - Each

Car Wash :

- Safely floats away dirt and grime
- Leaves a sparkling, streak free finish on cars new and old
- Enhances previously polished surfaces
- 1 Gallon container



Item # M64070
U/M - Each

Jumper Cables :

- T* prene insulation
- No- tangle construction with flexible copper wire and heavy duty copper plated steel clamps
- 200 amp clamps
- Black jacket
- 12' length



Item # M64074
U/M - Each



MILL SUPPLY CO., INC.

Phone (410) 485-3343
Fax (410) 325-2240

Toll Free 1-800-817-8183



Paint & Sundries

Paint & Sundries

LA·CO.
Markal

UGL

3M

KRYLON
INDUSTRIAL

RED DEVIL

HYDE
TOOLS

Red Devil 

Magic

LINZER
BRUSHES & ROLLERS
Since 1892



MILL SUPPLY CO., INC.

Phone (410) 485-3343
Fax (410) 325-2240

Toll Free 1-800-817-8183

Paint & Sundries

PAINT SUPPLIES

White Chinese Bristle Brush :

- Chip
- Wood handle
- For use with varnish, oil based paints, stains, and clear finishes
- Economy quality



Item #	U/M	Size
M63401	Each	1/2"
M63402	Each	1"
M63404	Each	2"
M63406	Each	3"
M63408	Each	4"

Polyester Bristle Brush :

- Silver handle
- Chiseled trim
- For use with latex paints
- Deluxe quality



Item #	U/M	Size
M63409	Each	1"
M63411	Each	2"
M63412	Each	2-1/2"
M63413	Each	3"

Black Chinese Bristle Brush :

- Silver handle
- Chiseled trim
- For use with varnish, oil based paints, stains, and clear finishes
- Deluxe quality



Item #	U/M	Size
M63425	Each	1"
M63427	Each	2"
M63429	Each	2-1/2"
M63431	Each	3"

Radiator Brush:

- Black chinese bristle
- Extra long plain wood handle
- Bent ferrule

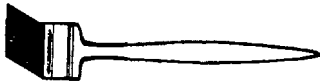

Item # M63443
U/M - Each

Roller Frames :

- 1/4" rod
- Threaded plastic grip
- 4 wire cage (3-7")
- 5 wire cage (9")

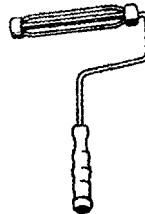

Item #	U/M	Size
M63512	Each	3"
M63514	Each	4"
M63516	Each	7"
M63518	Each	9"

Roller Covers Single Pack :

- For use with all paints

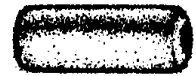

Item #	U/M	Surface	Size
M63553	Each	Semi-Smooth	3"
M63556	Each	Semi-Smooth	4"
M63559	Each	Semi-Smooth	7"
M63574	Each	Smooth	9"
M63568	Each	Semi-Smooth	9"
M63566	Each	Rough	9"

Roller Covers Twin Pack :

- 100% polyester
- Economy twin pack
- 2 rollers per pack
- Sold per pack only

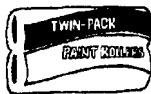

Item #	U/M	Size
M63576	Pack	3"
M63575	Pack	9"

Roller Trays:

- Regular tray has ladder lock legs, 11-1/4"x15-1/4"x2" deep
- Heavy duty tray has ladder lock legs, 11-1/4"x16-1/4"x3" deep
- Both are metal

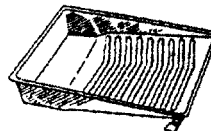

Item #	U/M	Type
M63628	Each	Regular
M63635	Each	Heavy-Duty

Roller Tray Liners :

- Standard plastic tray liner
- Solvent resistant

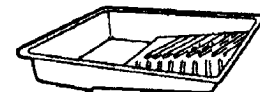

Item # M63637
U/M - Each



MILL SUPPLY CO., INC.

Phone (410) 485-3343
Fax (410) 325-2240

Toll Free 1-800-817-8183

Paint & Sundries

PAINT SUPPLIES

Roller & Tray Sets :

- For all paints and stains
- 3" set includes 3" shed free roller cover with frame and durable clear plastic mini tray
- 9" set includes 9" economy cover, slip-off roller frame

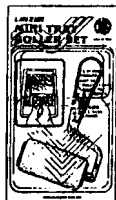

Item #	U/M	Size
M63613	Each	3"
M63614	Each	9"

Paint Bucket:

- Multi-purpose paint bucket
- 5 quart capacity



Item # M63643
U/M - Each

Paint Bucket Grid:

- 5 gal metal mesh grid for buckets and paint trays

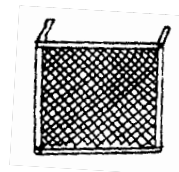

Item # M63641
U/M - Each

Plastic Drop Cloth :

- Extra heavy duty embossed
- 9'x12' covers up to 108 sq. ft., 2.0 mil
- Clear plastic offers protection against paint spills, water and dust.
- Use as a utility cover for cars, boats, motorcycles, and furniture



Item # M63655
U/M - Each

Canvas Drop Cloth :

- 9'x12' canvas drop cloth
- Full panel
- Reusable and washable



Item # M63659
U/M - Each

Waterproofing Sealer Kit :

- Kit contains all materials needed to apply waterproofing sealants
- 4 pc. set includes 1/2" nap cover, heavy duty frame, 12" deep well plastic tray, 3 pc. extension pole

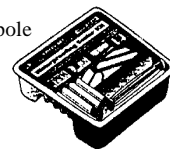

Item # M63645
U/M - Each

Shoe Handle Wire Brush :

- For all types of maintenance on wood, cement, brick, stone, metal, etc.
- Tempered steel wire bristles
- Shoe handle provides strong grip for applying pressure with hanging hole.



Item # M63501
U/M - Each

Long Curved Wire Brush :

- For all types of general purpose maintenance, residential, commercial and industrial
- Tempered steel wire bristles
- Curved hardwood 14"x1" block with hanging hole



Item # M63505
U/M - Each

Stainless Wire Brush :

- Premium quality hardwood handle
- Tempered steel wires
- Multi-purpose
- Handle is only 7-3/4" long; excellent for small jobs

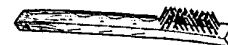

Item # M63509
U/M - Each



MILL SUPPLY CO., INC.

Phone (410) 485-3343
Fax (410) 325-2240

Toll Free 1-800-817-8183

Paint & Sundries

SPRAY PAINT

Interior / Exterior Spray Enamel:

- Multi-purpose
- Gives surfaces a fresh new look
- For interior or exterior
- Dries tack free in 15 min.
- Lead free and nontoxic when dry
- 11 oz can
- Sold by the each



Item # M63030
Color - Fire Red



Item # M63042
Color - Sun Yellow



Item # M63048
Color - Kelly Green



Item # M63054
Color - Royal Blue



Item # M63072
Color - Almond



Item # M63066
Color - Gloss White



Item # M63114
Color - Clear



Item # M63084
Color - Walnut



Item # M63126
Color - Gold



Item # M63102
Color - Flat Black



Item # M63108
Color - Gloss Black



Item # M63120
Color - Silver Aluminum

Case Qty.
6/ea

Krylon[®] OSHA Safety Spray Paint :

- Safety colors for industry and home
- Matches OSHA color standards
- It is the perfect paint for making safety and other markings at industrial and work sites
- Can be used on wood, metal, paper and most plastics
- Approx. 20-25 square feet of coverage
- 11 oz can
- Sold by the each



Item # M63281
Color - Safety Orange



Item # M63283
Color - Safety Green



Item # M63284
Color - Safety Yellow

Case Qty.
6/ea

Red Devil[®] Interior / Exterior BBQ & Hi-Temp:

- Withstands temperatures to 1000 degrees
- Safe for use on grills, furnaces, fireplace equipment and wood-burning stoves
- **Not** for use on kitchen stoves
- Approx. 20 square feet of coverage
- 11 oz can



Item # M63256
Color - Aluminum



Item # M63251
Color - White



Item # M63262
Color - Black

Case Qty.
6/ea

Red Devil[®] Interior / Exterior Epoxy Enamel:

- Ultra hard finish
- Long term durability
- Resists moisture
- Great for use on: metal, wood, masonry, most plastics, kitchen cabinets, outdoor furniture, lamp posts, fences, tools and gardening equipment
- 11 oz can
- Sold by the each



Item # M63218
Color - Almond



Item # M63206
Color - Gloss White



Item # M63227
Color - Walnut

Case Qty.
6/ea

Interior / Exterior Primer:

- Tough, dependable and sandable
- Forms a tight bond that resists rust and corrosion on any surface
- Excellent on: rusted or unrusted metal, cast iron, wood or porous surfaces
- 11 oz can



Item # M63020
Color - Red Primer



Item # M63014
Color - Grey Primer

Case Qty.
6/ea



MILL SUPPLY CO., INC.

Phone (410) 485-3343
Fax (410) 325-2240

Toll Free 1-800-817-8183

Paint & Sundries

MARKING / STRIPING PAINT

Krylon[®] Inverted Tip Spray Paint :

- Ideal for marking the most common indoor and outdoor surfaces
- Fast-drying, high-solids formula penetrates and adheres to hot surfaces
- Convenient Spray-Thru cap and non-clogging spray tip
- 16oz. can
- Sold by the each
- Water based - for short term striping



Case Qty.
12/ea

- Made to fit Krylon[®] hand held wands, not for use with striping machine



Item # M63287
Color - Bright Orange



Item # M63288
Color - Safety Green

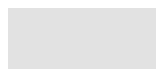

Item # M63289
Color - Safety Yellow



Item # M63290
Color - Utility White

Krylon[®] Wheeler Hand-Held Wand :

- 34" length
- Constructed of durable, rugged plastic and lightweight steel
- Comfortable pistol grip for easy handling and marking
- Applies a uniform, 1" to 1-1/2" width of paint



Item # M63292
U/M - Each

Krylon[®] Spotter Hand-Held Wand :

- 12" length
- Constructed of durable, rugged plastic and lightweight steel
- Comfortable pistol grip for easy handling and marking
- Applies a uniform, 1" to 1-1/2" width of paint



Item # M63293
U/M - Each

Krylon[®] Striping Paint :

- Made exclusively for striping machines
- Solvent based - for long lasting durability on outdoor pavement and indoor surfaces
- Non-clogging spray tip
- VOC - compliant and lead free
- 20 oz. can / sold by the each
- Will not fit in our hand held marking wands



Case Qty.
12/ea



Item # M63297
Color - Highway White



Item # M63299
Color - Highway Yellow



Item # M63304
Color - Firelane Red

Krylon[®] Striping Machine :

- Professionally stripes lots, fields, industrial and hospital areas
- 4 spraying positions for great results
- Includes angle attachment for curbs
- 18 gauge all-steel construction
- 12 can storage
- Stripes widths of 2" to 4"



Item # M63294
U/M - Each

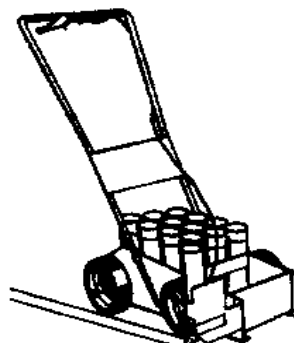

MILL SUPPLY CO., INC.

Phone (410) 485-3343
Fax (410) 325-2240

Toll Free 1-800-817-8183

Paint & Sundries

MISCELLANEOUS PAINT PRODUCTS

Dura-Ink Marker :



- Permanent marking
- Smear-resistant, water-resistant, fast-drying
- Tough cap and plastic barrel for industrial use
- Use for cardboard, ceramics, glass, leather, lumber, paper, rubber, steel
- Sold by the each



Box Qty.
12/ea

Item #	U/M	Color
M63703	Each	Red
M63706	Each	Black

Paintstick Marker :



- Real paint in stick form
- Weather-resistant, UV-resistant
- Ideal for layout, color coding, fabrication, and identification
- Marks through oil and water
- Marks on smooth, rough, rusty or dirty surfaces
- For use on metal, wood, plastic, concrete, rubber, glass, cardboard, and paper
- Lead-free, non-toxic
- 12 markers per box
- Sold by the box



Case Qty.
12/bx

Item #	U/M	Color
M63725	Box	White
M63722	Box	Black

Appliance Touch-Up Paint:

- Dries quickly to brilliant glossy finish
- Hides ugly chips and scars on appliances, sinks, bathtubs
- Easy to apply with handy brush cap applicator
- Fast drying, water resistant
- 1oz bottle
- Sold by the each



Item #	U/M	Color
M63343	Each	White
M63349	Each	Almond

Kilz[®]

- Universal sealer-primer, stain blocker
- Holds water stains, seals back graffiti, lipstick, crayon, inks, smoke and grease stains.
- 13oz. can/gal



Item #	U/M	Size
M63008	Each	13oz Spray
M63009	Each	1 Gallon

Latex Enamel :

- For use on walls, ceilings, drywall, plaster, masonry, primed wood and primed metal
- Offers a uniform semi-gloss sheen.
- Apply by brush, roller, or spray
- Water cleanup
- Dry time to touch 1 hour, recoat in 4 to 6 hours
- Sold by the gallon



Item #	U/M	Color	Size
M63333	Each	Hi-Hide White	1 Gal
M63331	Each	Antique White	1 Gal
M63339	Each	Hi-Hide White	5 Gal
M63337	Each	Antique White	5 Gal



MILL SUPPLY CO., INC.

Phone (410) 485-3343
Fax (410) 325-2240

Toll Free 1-800-817-8183

Paint & Sundries

PAINT SUPPLIES

3M Safety Paint Stripper :

- 3M's safest paint remover
- Can be applied indoors without gloves or special ventilation
- Effectively strips surfaces without harming wood
- Lifts several coats of paint in one application
- No harmful methylene chloride fumes
- Non-flammable
- Sold by the gallon



Item # M63389
U/M - Each

Acetone Solvent :

- 100% pure
- Strong, fast acting
- Cleaner and remover for specified resins, inks, adhesives and contact cement
- Sold by the gallon

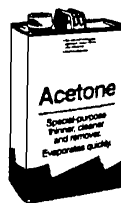

Item # M63377
U/M - Each

Paint Thinner :

- 100% pure mineral spirits
- Thins oil-based paint and varnish
- Cleans brushes and degreaser tools
- Sold by the gallon



Item # M63379
U/M - Each

Lacquer Thinner :

- A high-solvency thinner for lacquer and most epoxies
- Cleans brushes, tools and equipment after use
- Medium drying formula
- Sold by the gallon



Item # M63383
U/M - Each

Turpentine :

- Use whenever turpentine, paint thinner or mineral spirits are specified for thinning oil-based paint, varnish and enamel
- Superior solvency
- Sold by the gallon



Item # M63385
U/M - Each

S-L-X Denatured Alcohol :

- Thins shellac and cleans brushes, glasses and metal surfaces
- Used as a clean-burning fuel for marine stoves
- Sold by the gallon

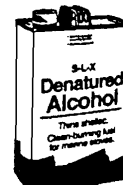

Item # M63381
U/M - Each

Interior Polyurethane :

- "Original" Polyurethane finish
- Outwears varnishes, lacquers
- Resists ring marks, water spots and household chemicals
- Never needs waxing or polishing
- For furniture, cabinets, doors, floors, and paneling
- Coverage - 500 to 600sf
- Sold per gallon



Item # M63397
U/M - Each

Exterior Polyurethane :

- Provides absolute protection on exterior wood surfaces
- Use on siding, gables, patio furniture, metal and fiberglass doors
- Contains radiation absorbers to resist damaging ultraviolet rays
- Long lasting marine finish
- Coverage - 500 to 600sf
- Sold per gallon



Item # M63396
U/M - Each



MILL SUPPLY CO., INC.

Phone (410) 485-3343
Fax (410) 325-2240

Toll Free 1-800-817-8183



Maintenance

Maintenance



MILL SUPPLY CO., INC.

Phone (410) 485-3343
Fax (410) 325-2240

Toll Free 1-800-817-8183

Maintenance

Hose
Clamps
Page 17

MAINTENANCE

Semi-Rigid Aluminum Duct :

- For dryer venting, bathroom fan exhaust ducting, furnace fresh air intake ducting, fireplace fresh air intake ducting, non-insulated ventilation ducting
- 4" x 25'



Item # M70007
U/M - Each

Aluminum Dryer Vent Hose :

- SUPurr-Flex
- Dryer Manufacturer Approved
- 5 layer holds rigid shape
- Pure aluminum
- 4" x 50'

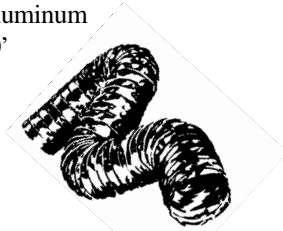

Item # M70027
U/M - Each

Vinyl Hose :

- White
- Multi-purpose uses
- Not recommended for use with dryers

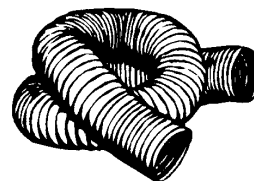

Item #	U/M	Size
M70040	Each	4"x20'
M70041	Each	4"x50'

Universal Bird Guards :

- Designed to fit over any style 3" or 4" vent hood



Item #	U/M	Color
M70051	Each	White
M70052	Each	Brown

Vent Louvers :

- For bath fan and dryer venting
- 4" x 4"

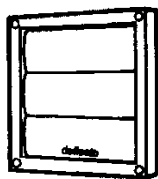

Item #	U/M	Color
M70056	Each	White
M70057	Each	Brown

Louvered Vent Hoods :

- 4" Louvered vent hood includes hood, aluminum pipe and collar

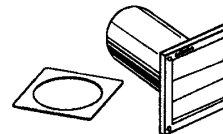

Item #	U/M	Color
M70078	Each	White
M70079	Each	Brown

Louvered Vent Hoods w/Grid :

- For bath fan venting
- Includes hood, pipe and collar
- 3"x 3"
- White

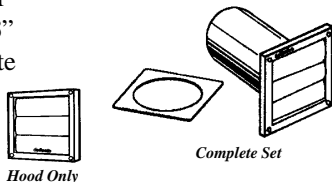

Item #	U/M	Desc.
M70086	Each	Hood Only
M70092	Each	Complete Set

Plastic Clamp :

- Fits both 3" and 4" vents
- ratchet clamp

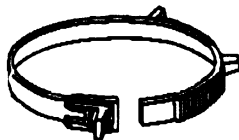

Item # M70101
U/M - Each

Dryer Vent Kits :

- 4" Louvered vent hood includes hood, aluminum pipe, vinyl hose, collar, and clamps

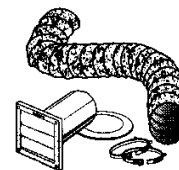

Item #	U/M	Color
M70111	Each	White
M70112	Each	Brown

Maintenance



MILL SUPPLY CO., INC.

Phone (410) 485-3343
Fax (410) 325-2240

Toll Free 1-800-817-8183

Maintenance

HEATING & COOLING

Lint Trap Kit :

- Needs no outside venting
- Adapts to any dryer
- Ideal for mobile homes, apartments, and condominiums
- Saves energy

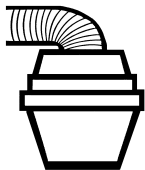

Item # M70122
U/M - Each

Gas Valves :

- 2 Piece
- AGA approved
- CGA approved
- Quarter turn operation
- -20 degrees to + 125 degrees
- Teflon seals

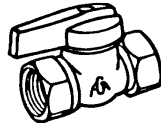

Item #	U/M	Size
M99902	Each	1/2"
M99903	Each	3/4"

Female Adapter :

- Stainless Steel
- AGA approved
- Sold by the each

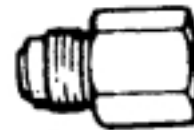

Item #	U/M	Size
M70329	Each	1/2"
M70445	Each	3/4"

Stainless Steel Gas Lines :

- Variety of sizes to fit multiple applications
- Superior strength
- Superior corrosion resistance
- Certified for both indoor and outdoor use
- Available in a wide range of sizes and configurations
- Sold by the each

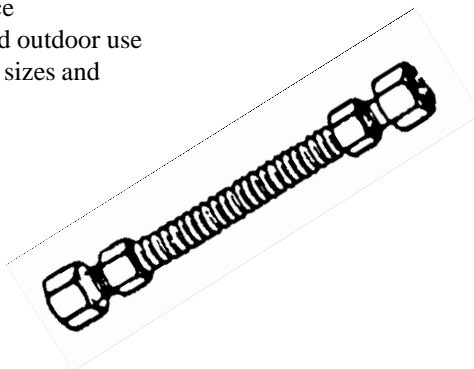

Male Adapter :

- Stainless Steel
- AGA approved
- Sold by the each



Item #	U/M	Size
M70331	Each	1/2"
M70339	Each	3/4"

Ends	Sizes						
	12"	18"	24"	30"	36"	48"	60"
1/2F x 1/2F	M70252	M70263	M70275	M70286	M70297	M70308	M70319
1/2M x 1/2M	M70253	M70264	M70276	M70287	M70298	M70309	M70320
1/2M x 1/2F	M70254	M70265	M70277	M70288	M70299	M70310	M70321
1/2F x 3/4M	M70255	M70266	M70278	M70289	M70300	M70311	M70322
1/2F x 3/4F	M70256	M70267	M70279	M70290	M70301	M70312	M70323
1/2M x 3/4F	M70257	M70268	M70280	M70291	M70302	M70313	M70324
1/2M x 3/4M	M70258	M70269	M70281	M70292	M70303	M70314	M70325
3/4M x 3/4M	M70259	M70270	M70282	M70293	M70304	M70315	M70326
3/4F x 3/4M	M70260	M70271	M70283	M70294	M70305	M70316	M70327
3/4F x 3/4F	M70261	M70273	M70284	M70295	M70306	M70317	M70328



MILL SUPPLY CO., INC.

Phone (410) 485-3343
Fax (410) 325-2240

Toll Free 1-800-817-8183

Maintenance

HEATING & COOLING

Sidewall Register :

- Multi-louvered damper permits use with both heating and cooling applications
- Fin design directs air pattern left and right 30 degrees from center and vertically 45 degrees
- One piece face design
- Electro-deposition white finish

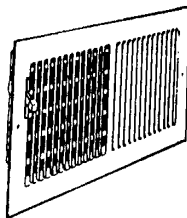

Item #	U/M	Size
M70134	Each	8" x 4"
M70136	Each	10" x 4"
M70138	Each	10" x 6"
M70140	Each	10" x 8"
M70142	Each	12" x 4"
M70144	Each	12" x 6"
M70146	Each	14" x 4"
M70148	Each	14" x 6"

Floor Register :

- One piece heavy gauge steel face
- Easy to operate damper
- Expansion tabs lock diffuser firmly into floor
- Tough durable brown finish

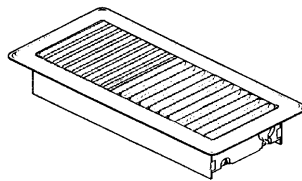

Item #	U/M	Size
M70161	Each	2-1/4" x 10"
M70165	Each	2-1/4" x 12"
M70172	Each	2-1/4" x 14"
M70177	Each	4" x 10"
M70184	Each	4" x 12"
M70192	Each	4" x 14"

Return Air Grill :

- One piece, heavy gauge steel grill ideal for residential and commercial use
- Fins spaced three to the inch are swept back 22 degrees to conceal opening
- Electro-deposition white finish

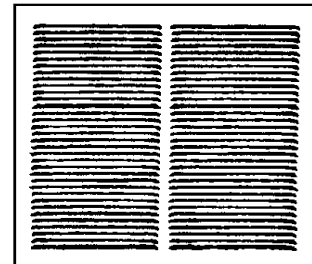

Item #	U/M	Size
M70202	Each	10" x 6"
M70204	Each	10" x 8"
M70206	Each	14" x 14"
M70210	Each	20" x 10"
M70212	Each	20" x 12"
M70214	Each	20" x 14"
M70216	Each	24" x 12"

A/C Furnace Filter :

- Disposable panel filters are designed to withstand the demands of tough industrial and commercial applications
 - Tri-directional scrim backing increases filter integrity
 - Safe, easy, fast installation
- Sold in full box quantities only*

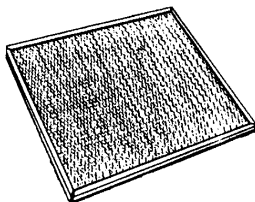

Item #	U/M	Size	Qty per Box
M71320	Each	10" x 20" x 1"	24 Each
M71325	Each	10" x 24" x 1"	24 Each
M71340	Each	10" x 25" x 1"	24 Each
M71350	Each	10" x 30" x 1"	24 Each
M71390	Each	12" x 20" x 1"	24 Each
M71410	Each	12" x 24" x 1"	24 Each
M71415	Each	12" x 25" x 1"	24 Each
M71430	Each	12" x 30" x 1"	24 Each
M71490	Each	14" x 20" x 1"	24 Each
M71510	Each	14" x 24" x 1"	24 Each
M71515	Each	14" x 25" x 1"	24 Each
M71550	Each	15" x 20" x 1"	24 Each
M71595	Each	16" x 20" x 1"	24 Each
M71605	Each	16" x 24" x 1"	24 Each
M71615	Each	16" x 25" x 1"	24 Each
M71650	Each	20" x 20" x 1"	24 Each
M71660	Each	20" x 25" x 1"	24 Each
M71690	Each	25" x 25" x 1"	24 Each



Fiberglass Filter Mat :

- Consists of high loft gradient density fiberglass which allows deep dirt penetration assuring high-dirt holding capacity and maximum filtration efficiency



Item #	U/M	Size
M71781	Each	20' x 24" x 1"
M71791	Each	20' x 30" x 1"



MILL SUPPLY CO., INC.

Phone (410) 485-3343
Fax (410) 325-2240

Toll Free 1-800-817-8183

Maintenance

HEATING & COOLING

Ductless Range Hood :

NuTone®

- Removes grease and odors from kitchen
- Built-in enclosed light, provides light on your range surface
- Activated charcoal filter to absorb cooking odors

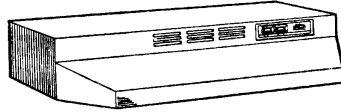

Item #	U/M	Size	Color
M70514	Each	24"	White
M70524	Each	30"	White
M70536	Each	24"	Almond
M70554	Each	30"	Almond

Ducted Range Hood :

NuTone®

- Removes grease and odors from kitchen / 3-1/4" x 10" rectangle duct
- Built-in enclosed light, provides light on your range surface



Item #	U/M	Size	Color
M70512	Each	24"	White
M70518	Each	30"	White
M70530	Each	24"	Almond
M70542	Each	30"	Almond

Aluminum Grease Filter :

- For use with range hoods, exhaust fans, etc.

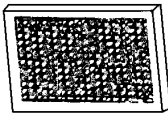

Item #	U/M	Size
M71007	Each	7-1/4" x 9-1/2"
M71012	Each	8" x 9-1/2"
M71017	Each	8-1/4" x 11-1/4"
M71027	Each	8-3/4" x 10-1/2"
M71037	Each	9" x 10-3/32"
M71042	Each	10-1/8" x 10-15/16"

Aluminum Grease Filter :

- For use with range hoods, exhaust fans, etc.



Item #	U/M	Size
M71104	Each	8"
M71108	Each	10"

Charcoal Filter :

- For use with range hoods, exhaust fans, etc.
- 7-1/2" x 10-1/2"

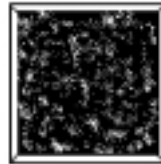

Item # M71156
U/M - Each

Bath Fan :

NuTone®

- 50 CFM, 4.0 sones fan - for bathrooms up to 45 sq. ft.
- Plug-in, permanently lubricated motor
- UL listed for use over bathtubs and showers (when connected to GFCI)
- White grill
- Housing: 7-1/4" x 7-1/2" x 3-5/8" high
- Grill: 8-11/16" x 9-1/2"

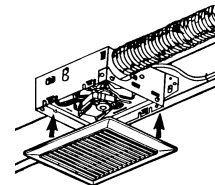

Item # M84915
U/M - Each

Fan Blade : NuTone®

- Replacement fan blade for Nutone "RL" series range hood
- Ducted blade shown
- Sold by the each



Item #	U/M	Range Hood Type
M70894	Each	Ducted
M70898	Each	Ductless

Splash Plate : NuTone®

- For beautification and protection of kitchen wall above the range and below the range hood
- Easy to install and clean
- 30" x 24"
- White on one side and almond on the other
- Sold by the each



Item # M70461
U/M - Each

Motor : NuTone®

- Replacement motor for Nutone "RL" series range hood

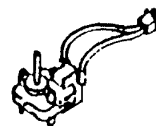

Item #	U/M	Range Hood Type
M70895	Each	Ducted
M70896	Each	Ductless

Light Lens : NuTone®

- Snap in replacement lense cover for Nutone "RL" series range hood



Item # M70889
U/M - Each

Maintenance



MILL SUPPLY CO., INC.

Phone (410) 485-3343
Fax (410) 325-2240

Toll Free 1-800-817-8183

Maintenance

RANGE & RANGE HOOD PARTS

Electric Top Burner Knobs :

- Fits most **electric** ranges
- Sold in pack of 4 only
- Includes 20 adapter inserts

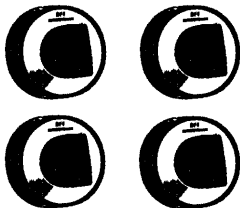

Item # M71210
U/M - Pack

Electric Oven Knob :

- Fits most **electric** ranges
- Sold by the each
- Includes 5 adapter inserts



Item # M71204
U/M - Each

Gas Oven Knob :

- Fits most **gas** ranges
- Sold by the each
- Includes 1 adapter insert

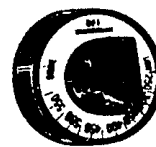

Item # M71207
U/M - Each

Gas Top Burner Knobs :

- Fits most **gas** ranges
- Sold in pack of 4 only
- Includes 4 adapter inserts

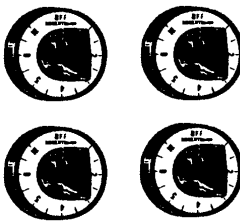

Item # M71214
U/M - Pack

Range Drip Pan :

- For plug-in elements
- Heavy chrome plating

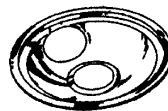

Item #	U/M	Size
M71228	Each	6"
M71240	Each	8"

Range Drip Pan :

- Heavy chrome plating



Item #	U/M	Size
M71231	Each	6"
M71243	Each	8"

Range Drip Pan :

- High quality steel construction
- "Penta-Plex" chrome plating provides better corrosion resistance
- With removable electric elements



Item #	U/M	Size
M71266	Each	6"
M71269	Each	8"

Range Trim Ring :

- Use with metal or porcelain pans
- Heavy chrome plating



Item #	U/M	Size
M71282	Each	6"
M71289	Each	8"

Broiler Pan :

- Porcelain and chrome
- Rugged, easy to clean porcelain pan with chrome rack
- 16-1/2" x 12-3/4" x 1-5/8"



Item # M71255
U/M - Each



MILL SUPPLY CO., INC.

Phone (410) 485-3343
Fax (410) 325-2240

Toll Free 1-800-817-8183

Maintenance

BLINDS

1" Vinyl Mini-Blinds :

- With tilt wand and valance
- Safety tassel included
- Easy to install, operate, clean and shorten
- Tapeless construction
- Includes all mounting hardware
- Lead free



Size (WxL)	U/M	Item # (White)	Item # (Alabaster)
35" x 64"	Each	M77931	M78378
36" x 64"	Each	M77959	M78392
37" x 64"	Each	M77973	M78406
38" x 64"	Each	M77975	M78420
39" x 64"	Each	M77987	M78434
40" x 64"	Each	M78001	M78448
41" x 64"	Each	M78015	M78462
42" x 64"	Each	M78029	M78476
43" x 64"	Each	M78043	M78490
45" x 64"	Each	M78045	M78504
46" x 64"	Each	M78047	M78518
47" x 64"	Each	M78071	M78532
48" x 64"	Each	M78085	M78546
50" x 64"	Each	M78087	M78560
52" x 64"	Each	M78089	M78574
54" x 64"	Each	M78091	M78588
58" x 64"	Each	M78093	M78602
59" x 64"	Each	M78099	M78616
60" x 64"	Each	M78101	M78630
68" x 64"	Each	M78103	M78658
70" x 64"	Each	M78113	M78672
71" x 64"	Each	M78115	M78686
72" x 64"	Each	M78117	M78700

Size (WxL)	U/M	Item # (White)	Item # (Alabaster)
23" x 64"	Each	M77819	M78168
23" x 72"	Each	M77833	M78182
24" x 64"	Each	M77847	M78196
25" x 64"	Each	M77849	M78210
26" x 64"	Each	M77851	M78224
27" x 64"	Each	M77861	M78238
27" x 72"	Each	M77863	M78252
28" x 64"	Each	M77875	M78266
29" x 64"	Each	M77879	M78280
29" x 72"	Each	M77889	M78294
30" x 64"	Each	M77891	M78308
31" x 64"	Each	M77903	M78322
32" x 64"	Each	M77905	M78331
33" x 64"	Each	M77907	M78350
34" x 64"	Each	M77917	M78364

Vertical Blinds :

- Easy to install
- Heavy-duty headrail
- Thicker vinyl ribbed vanes
- Curved design for stability and appearance
- Dust repellent vertical vanes
- All hardware and instructions included
- Reversible headrail for left or right one-way draw
- 3-1/2" vertical vanes
- Maintenance free
- **Includes valance**
- For 6' high patio doors

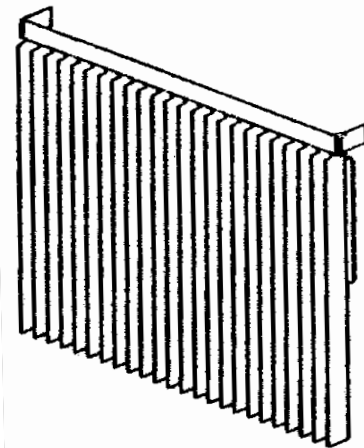

White

Item #	U/M	Size (WxL)
M79601	Each	78" x 84"
M79701	Each	104" x 84"

Alabaster

Item #	U/M	Size (WxL)
M79851	Each	78" x 84"
M79951	Each	104" x 84"



MILL SUPPLY CO., INC.

Phone (410) 485-3343
Fax (410) 325-2240

Toll Free 1-800-817-8183



Electrical

Electrical

INTERMATIC®

3M

SLI LIGHTING

**WSI™
ELECTRIC**

EAGLE

**Leadco
LIGHTING**

RACO®

 **COLEMANCABLE**

Mulberry



MILL SUPPLY CO., INC.

Phone (410) 485-3343
Fax (410) 325-2240

Toll Free 1-800-817-8183

Electrical

INCANDESCENT BULBS

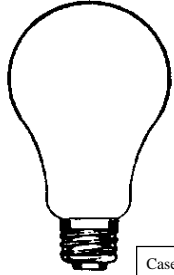

Case Qty.
120/ea

A-19

- Medium base
- Multi-Filament supports increase lamp life
- Solid Nickel leads for extra support
- Brass base does not oxidize or freeze in the socket, for easy removal
- 130 Volt design to better withstand voltage surge



Case Qty.
120/ea

- Appliance bulb
- Same specs. as A-19 bulb
- A-15 bulb
- 40 watts, 5000 hours
- Inside frost finish

Item # **M87022**
U/M - Each

Item #	U/M	Description	Watts	Type	Volts	Hours
M88018	Each	25A/IF	25	Inside Frost	130	5000
M88153	Each	40A/IF	40	Inside Frost	130	5000
M88279	Each	60A/CL	60	Clear	130	5000
M88288	Each	60A/IF	60	Inside Frost	130	5000
M88360	Each	75A/RS/IF	75	Rough Service	130	2500
M88405	Each	75A/IF	75	Inside Frost	130	5000
M88414	Each	100A/IF	100		130	5000

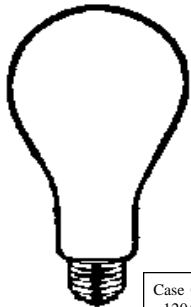

Case Qty.
120/ea

A-21

- Medium base
- Multi-Filament supports increase lamp life
- Solid Nickel leads for extra support
- Brass base does not oxidize or freeze in the socket, for easy removal
- 130 Volt design to better withstand voltage surge

Item #	U/M	Description	Watts	Type	Volts	Hours
M88495	Each	150A21/IF	150	Inside Frost	130	5000

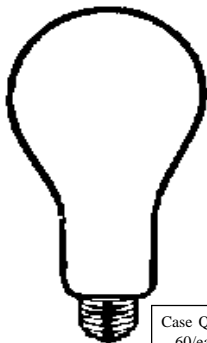

Case Qty.
60/ea

A-23

- Medium base
- Multi-Filament supports increase lamp life
- Solid Nickel leads for extra support
- Brass base does not oxidize or freeze in the socket, for easy removal
- 130 Volt design to better withstand voltage surge

Item #	U/M	Description	Watts	Type	Volts	Hours
M88522	Each	200A23/IF	200	Inside Frost	130	5000

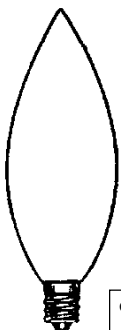

Case Qty.
25/ea

B-10

- Candelabra base
- Straight tip
- Brass base does not oxidize or freeze in the socket, for easy removal
- 130 Volt design to better withstand voltage surge

Item #	U/M	Description	Watts	Type	Volts	Hours
M88027	Each	25TC/CL/BX	25	Clear	130	3000
M88036	Each	25TC/IF/BX	25	Inside Frost	130	3000
M88171	Each	40TC/CL/BX	40	Clear	130	3000
M88180	Each	40TC/IF/BX	40	Inside Frost	130	3000
M88297	Each	60TC/CL/BX	60	Clear	130	3000



MILL SUPPLY CO., INC.

Phone (410) 485-3343
Fax (410) 325-2240

Toll Free 1-800-817-8183

Electrical

INCANDESCENT BULBS



Case Qty.
25/ea

B-11

- Medium base
- Straight tip
- Brass base does not oxidize or freeze in the socket, for easy removal
- 130 Volt design to better withstand voltage surge

Item #	U/M	Description	Watts	Type	Volts	Hours
M88045	Each	25TM/CL/BX	25	Clear	130	3000
M88189	Each	40TM/CL/BX	40	Clear	130	3000

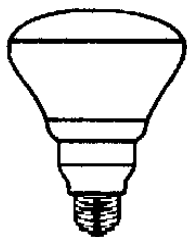

Case Qty.
130/ea

BR-30

- Medium base
- Indoor Reflector
- Brass base does not oxidize or freeze in the socket, for easy removal
- 130 Volt design to better withstand voltage surge

Item #	U/M	Description	Watts	Type	Volts	Hours
M88387	Each	65BR30/FL	65	Flood Light	130	5000
M88396	Each	65BR30/SP	65	Spot Light	130	5000

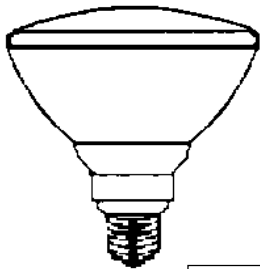

Case Qty.
12/ea

BR-38

- Medium base
- Indoor / Outdoor Reflector
- Brass base does not oxidize or freeze in the socket, for easy removal
- 130 Volt design to better withstand voltage surge

Item #	U/M	Description	Watts	Type	Volts	Hours
M88369	Each	75BR38/FL	75	Flood Light	130	5000
M88378	Each	75BR38/SP	75	Spot Light	130	5000
M88450	Each	150BR38/FL	150	Flood Light	130	5000
M88459	Each	150BR38/SP	150	Spot Light	130	5000

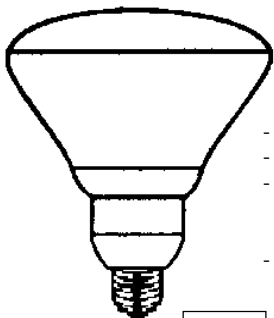

Case Qty.
24/ea

BR-40

- Medium base
- Indoor Reflector
- Brass base does not oxidize or freeze in the socket, for easy removal
- 130 Volt design to better withstand voltage surge

Item #	U/M	Description	Watts	Type	Volts	Hours
M88477	Each	120BR/FL	130	Flood Light	130	5000
M88486	Each	120BR/SP	130	Spot Light	130	5000



MILL SUPPLY CO., INC.

Toll Free 1-800-817-8183

Phone (410) 485-3343
Fax (410) 325-2240

Electrical

INCANDESCENT BULBS

G-16-1/2

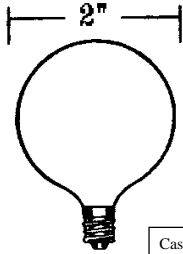

- Candelabra base
- Brass base does not oxidize or freeze in the socket, for easy removal
- 130 Volt design to better withstand voltage surge

Case Qty.
25/ea

Item #	U/M	Description	Watts	Type	Volts	Hours
M88072	Each	25G161/2/CL/BX	25	Clear	130	3000
M88081	Each	25G161/2/W/BX	25	White	130	3000
M88207	Each	40G161/2/CL/BX	40	Clear	130	3000
M88216	Each	40G161/2/W/BX	40	White	130	3000
M88315	Each	60G161/2/CL/BX	60	Clear	130	3000

G-25

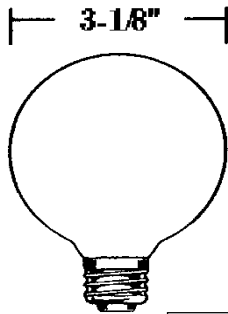

- Medium base
- Brass base does not oxidize or freeze in the socket, for easy removal
- 130 Volt design to better withstand voltage surge

Case Qty.
60/ea

Item #	U/M	Description	Watts	Type	Volts	Hours
M88090	Each	25G25/CL	25	Clear	130	5000
M88099	Each	25G25/W	25	White	130	5000
M88225	Each	40G25/CL	40	Clear	130	5000
M88234	Each	40G25/W	40	White	130	5000
M88324	Each	60G25/CL	60	Clear	130	5000
M88333	Each	60G25/W	60	White	130	5000

G-40

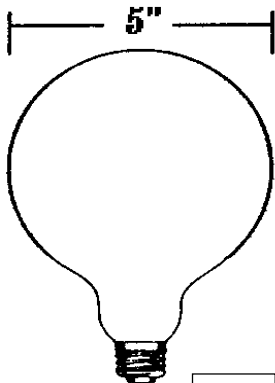

- Medium base
- Brass base does not oxidize or freeze in the socket, for easy removal
- 130 Volt design to better withstand voltage surge

Case Qty.
24/ea

Item #	U/M	Description	Watts	Type	Volts	Hours
M88135	Each	40G40/W	40	White	130	5000
M88144	Each	40G40/CL	40	Clear	130	5000
M88342	Each	60G40/CL	60	Clear	130	5000
M88351	Each	60G40/W	60	White	130	5000
M88432	Each	100G40/W	100	White	130	5000



MILL SUPPLY CO., INC.

Phone (410) 485-3343
Fax (410) 325-2240

Toll Free 1-800-817-8183

Electrical

INCANDESCENT LAMPS

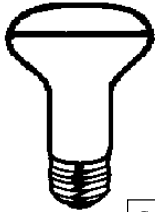

Case Qty.
60/ea

R-20

- Medium base
- Brass base does not oxidize or freeze in the socket, for easy removal
- 130 Volt design to better withstand voltage surge

Item #	U/M	Description	Watts	Type	Volts	Hours
M88270	Each	50R20/RFL	50	Reflector	130	5000

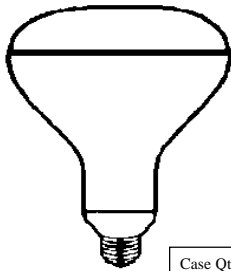

Case Qty.
12/ea

R-40

- Medium base
- Heat lamp
- Shatter proof
- 130 Volt design to better withstand voltage surge

Item #	U/M	Description	Watts	Type	Volts	Hours
M88531	Each	250R40/10/WP/BX	250	Heat Lamp	120	6000

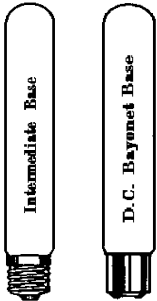

Case Qty.
25/ea

T-6-1/2

- EXIT sign bulb
- Brass base does not oxidize or freeze in the socket, for easy removal
- 130 Volt design to better withstand voltage surge

Item #	U/M	Description	Watts	Type	Volts	Hours
M88054	Each	20T61/2/CL/INT	20	Clear INT.	130	5000
M88063	Each	20T61/2/DC/CL	20	Clear D.C.	130	5000



Case Qty.
25/ea

T-10

- Medium base
- Brass base does not oxidize or freeze in the socket, for easy removal
- 130 Volt design to better withstand voltage surge

Item #	U/M	Description	Watts	Type	Volts	Hours
M88117	Each	25T10/IF	25	Inside Frost	130	5000
M88126	Each	40T10/IF	40	Inside Frost	130	5000



MILL SUPPLY CO., INC.

Phone (410) 485-3343
Fax (410) 325-2240

Toll Free 1-800-817-8183

Electrical

FLOURESCENT LAMPS

T-5

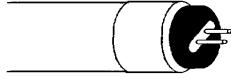

- Miniature Bipin Base
- Starter Required
- Cool White

Case Qty.
24/ea

Item #	U/M	Description	Watts	Length	Hours
M87076	Each	F6T5/CW	6	9"	10000
M87115	Each	F8T5/CW	8	12"	10000

T-8



- Medium Bipin Base
- Starter Required
- Cool White

M87180
Case Qty.
25/ea

M87245
Case Qty.
30/ea

Item #	U/M	Description	Watts	Length	Hours
M87180	Each	F15T8/CW	15	18"	10000
M87245	Each	F30T8/CW	30	36"	7500

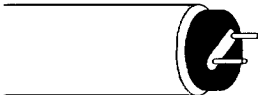

- Medium Bipin Base
- Rapid Start
- Rapid Start Starter Required
- Cool White

Case Qty.
25/ea

Item #	U/M	Description	Watts	Length	Hours
M87258	Each	F32T8/CW	32	48"	20000

T-12



- Medium Bipin Base
- Starter Required

M87167
Case Qty.
30/ea

M87206
Case Qty.
25/ea

Item #	U/M	Description	Watts	Length	Hours
M87167	Each	F15T12/CW	15	18"	10000
M87206	Each	F20T12/CW	20	24"	9000

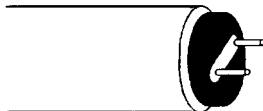

- Medium Bipin Base
- Rapid Start
- Rapid Start Starter Required
- Cool White

M87232
Case Qty.
25/ea

M87310
Case Qty.
30/ea

Item #	U/M	Description	Watts	Length	Hours
M87232	Each	F30T12/CW	30	36"	18000
M87310	Each	F40CW/ES	34	48"	20000

T-12

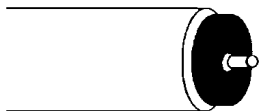

- Medium Single Pin Base
- Rapid Start
- Rapid Start Starter Required
- Cool White

Case Qty.
15/ea

Item #	U/M	Description	Watts	Length	Hours
M87323	Each	F96T12/CW/ES	60	96"	12000



MILL SUPPLY CO., INC.

Phone (410) 485-3343
Fax (410) 325-2240

Toll Free 1-800-817-8183

Electrical

FLOURESCENT LAMPS

T-12



- (RDC) Recessed Double Contact Base
- High Output
- Cool White

Case Qty.
15/ea

Item #	U/M	Description	Watts	Length	Hours
M87336	Each	F96T12/CW/HO-O	110	96"	12000

T-9

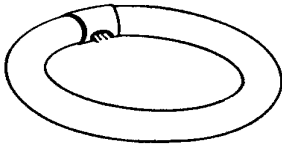

- Circline
- 4 Pin Base
- Cool White

Case Qty.
12/ea

Item #	U/M	Description	Watts	Size	Hours
M87193	Each	FC6T9/CW	20	6-1/2"	12000
M87219	Each	FC8T9/CW	22	8"	12000
M87271	Each	FC12C9/CW	32	12"	12000

G(X)-23

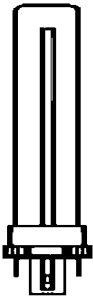

- PL Compact Fluorescent Lamp
- Lynx Single 2 Pin Base
- Energy Saver
- Cool White

Case Qty.
50/ea

Item #	U/M	Description	Watts	Base	Hours
M87063	Each	CF5LS/827	5	G-23	10000
M87089	Each	CF7LS/827	7	G-23	10000
M87128	Each	CF9LS/827	9	G-23	10000
M87141	Each	CF13LS/827	13	GX-23	10000

T-12

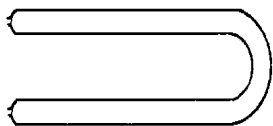

- U-Bent Lamp
- Medium 2-Pin Base
- Rapid Start
- Energy Saver
- Cool White

Case Qty.
12/ea

Item #	U/M	Description	Watts	Length	Hours
M87297	Each	FB40CW/ES/6	34	22-1/2"	12000



MILL SUPPLY CO., INC.

Phone (410) 485-3343
Fax (410) 325-2240

Toll Free 1-800-817-8183

Electrical

BULBS

High Pressure Sodium

ED-17/
ED-23-1/2



- High Pressure Sodium - Clear
- Sold by the each

Item #	U/M	Description	Watts	Base	Hours
M88762	Each	LU50/MED	50	Medium	24000
M88769	Each	LU70/MED	70	Medium	24000
M88788	Each	LU150/55MED	150	Medium	24000
M88807	Each	LU150/55/MOG	150	Mogul	24000

Case Qty.
20/ea

Quartz Halogen

T-3

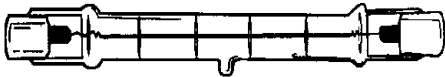

- Recessed single contact
- Mol (inch.) 4-11/16"
- Clear
- Sold by the each

Item #	U/M	Description	Volts	Watts	Base	Hours
M88558	Each	300T3Q/CL	130	300	RSC	2000
M88630	Each	500T3Q/CL	130	500	RSC	2000

Case Qty.
20/ea



MILL SUPPLY CO., INC.

Phone (410) 485-3343
Fax (410) 325-2240

Toll Free 1-800-817-8183

Electrical

FLOURESCENT FIXTURES

Wrap Around Fixture :

- 4' with energy saving ballast
- White fixture with prismatic diffuser
- Replace with 2/ea T-12 bipin bulbs

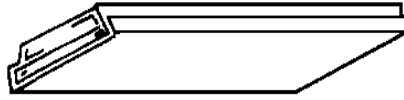

- * Replacement lens # **M85019**
- * Replacement ballasts # **M81059**

Item # M85010
U/M - Each

Wrap Around Fixture :

- 2' with residential ballast
- White fixture with prismatic diffuser
- Replace with 2/ea T-12 bipin bulbs



- * Replacement lens # **M85016**

Item # M85007
U/M - Each

Undercabinet Flourescent Fixture :

- 2'
- Steel housing
- White snap in lens
- On/Off switch
- Direct wire in
- Bulbs included

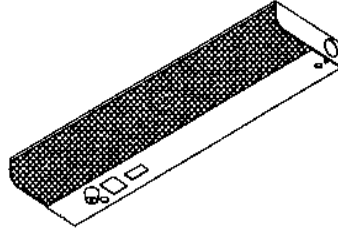

Item # M85028
U/M - Each

Wrap Around Fixture (Oak) :

- 4' with energy saving ballast
- Oak ends with prismatic diffuser
- Replace with 2/ea T-12 Bipib bulbs

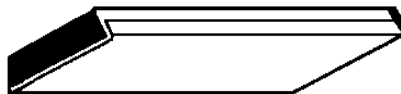

- * Replacement lens # **M85019**
- * Replacement ballast # **M85514**

Item # M85013
U/M - Each



MILL SUPPLY CO., INC.

Phone (410) 485-3343
Fax (410) 325-2240

Toll Free 1-800-817-8183

Electrical

LIGHTING FIXTURES

5 Light Chandelier :

- Polished brass colonial chandelier
- Uses five candelabra base bulbs (not included) up to 60W
- Diameter 18"
- Height 15"
- Replace with 5/ea B-10 type bulbs



Item # M85245
U/M - Each

5 Arm Hurricane Chandelier :

- Polished brass finish
- Uses five candelabra base bulbs (not included) up to 60W
- Clear chimney glass
- Diameter 21-3/4"
- Height 14"
- Includes 10' of wire
- Replace with 5/ea B-10 type bulb



Item # M85242
U/M - Each

Pendant Fixture :

- White finish
- White polystyrene shade
- Diameter 15-1/2"
- Height 13-1/2"
- Includes 10' of wire
- Replace with 1/ea G-40 type bulb



Item # M85308
U/M - Each



MILL SUPPLY CO., INC.

Phone (410) 485-3343
Fax (410) 325-2240

Toll Free 1-800-817-8183

Page 241

Electrical

LIGHTING FIXTURES

Mushroom Design Ceiling Fixture :

- White glass
- 8" width
- Extends 3-3/4"
- 60W maximum wattage
- Replace with 1/ea A-19 type bulb



Item #	Size	Trim	Repl. Glass
M85239	8"	Brass	M85580
M85296	8"	White	M85580

Ceramic Glass Drum Fixture :

- White glass
- White finish
- 8" width
- Extends 5"
- 60W maximum wattage - 8"
- 75W maximum wattage - 10"
- Replace with 2/ea A-19 type bulbs



Item #	Size	Repl. Glass
M85284	8"	M85592
M85292	10"	M85592

Pineapple Glass Ceiling Fixture :

- Crystal glass
- Polished brass finish
- 5" width
- Extends 6-1/2"
- 60W maximum wattage
- Replace with 1/ea A-19 type bulb



Item # M85230
U/M - Each

* Replacement Glass M85530

Glass Drum Fixture :

- Clear glass
- Chrome finish
- 10-1/4" width
- Extends 4-3/4"
- 75W maximum wattage
- Replace with 2/ea A-19 type bulbs



Item #	Size	Repl. Glass
M85275	8"	M85523
M85279	10"	M85526

Ceiling Mount Globe Fixture :

- White glass
- 6" width
- Extends 8"
- 60W maximum wattage
- Replace with 1/ea A-19 type bulb

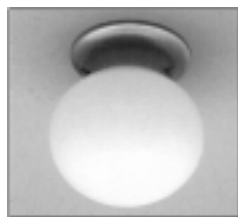

Item #	Size	Trim	Repl. Glass
M85229	6"	Brass	M85511
M85298	6"	White	M85511

Square Ceiling Fixture :

- White glass
- 12" width
- Extends 5"
- 60W maximum wattage
- Replace with 2/ea A-19 bulbs

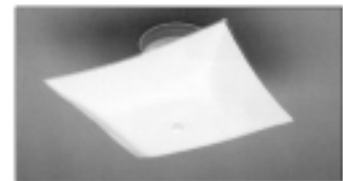

Item # M85302
U/M - Each

* Replacement Glass M85561



MILL SUPPLY CO., INC.

Phone (410) 485-3343
Fax (410) 325-2240

Toll Free 1-800-817-8183

Electrical

INDOOR WALL FIXTURES

Bathroom Striplite :

- Chrome finish
- 60W maximum wattage
- Can be installed with white or clear bulbs
- Replace with G-40 type bulbs

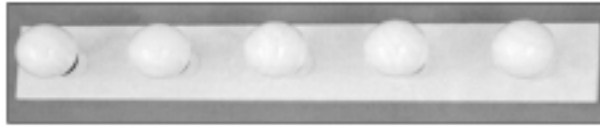

Item #	U/M	Size	Lights
M85203	Each	18"	3
M85206	Each	24"	4
M85209	Each	30"	5
M85212	Each	36"	6
M85215	Each	48"	8

Bathroom Fixture :

- White finish
- White ceramic glass
- Has grounded convenience outlet
- 75W maximum wattage
- 4-1/2" x 7-1/2"
- Extends 4-1/2"
- Replace with 1/ea A-19 type bulbs



Item # M85218
U/M - Each

* Replacement Glass M85517

Bathroom Fixture :

- White finish
- White ceramic glass
- Has grounded convenience outlet
- 75W maximum wattage
- 12" x 7-1/2"
- Extends 4-1/2"
- Replace with 2/ea A-19 type bulbs

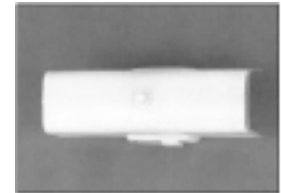

Item # M85221
U/M - Each

* Replacement Glass M85564

Bathroom Wall Fixture:

- White with a clear bottom
- Chrome wall bracket
- Convenience outlet
- 4-3/4" x 4-3/4"
- Extends 8"
- 100W maximum wattage
- Replace with 1/ea A-19 type bulbs

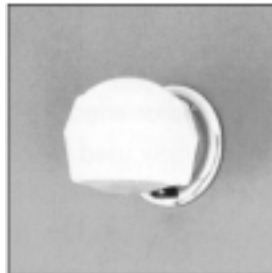

Item # M85227
U/M - Each

Bathroom Fixture :

- White ceramic glass
- Has grounded convenience outlet
- 24" x 4-1/2"
- Extends 4-1/2"
- 75W maximum wattage
- Replace with 4/ea A-19 type bulbs



Item # M85224
U/M - Each

* Replacement Glass M85567



MILL SUPPLY CO., INC.

Phone (410) 485-3343
Fax (410) 325-2240

Toll Free 1-800-817-8183

Electrical

OUTDOOR WALL FIXTURES

Black Wall Lantern :

- Black polycarbonate finish
- Clear ribbed glass
- 4-1/2" x 6"
- Extends 5-3/4"
- 60W maximum wattage
- Replace with 1/ea A-19 type bulb



Item # M85336
U/M - Each

Cylindrical Glass Wall Lantern :

- Black finish
- Ribbed crystal glass
- 4-1/2" x 6-1/2"
- Extends 5-1/2"
- 75W maximum wattage
- Replace with 1/ea A-19 type bulb



Item # M85329
U/M - Each

* Replacement Glass **M85514**

Cylindrical Glass Wall Lantern :

- Black polycarbonate finish
- Clear ribbed glass
- 4-1/2" x 6"
- Extends 5-3/4"
- 60W maximum wattage
- Replace with 1/ea A-19 type bulb



Item # M85333
U/M - Each



MILL SUPPLY CO., INC.

Phone (410) 485-3343
Fax (410) 325-2240

Toll Free 1-800-817-8183

Electrical

FLOURESCENT STARTERS/PHOTO CONTROLS

Flourescent Starters :

- All purpose two terminal standard starter accurately timed to combine starts with long bulb life
- For use where lights are turned on more than 5 times daily. Also in devices where life expectancy in less than 2 years



Flourescent Lamp Holder :

- 660W/600V
- White
- Slide on medium bi-pin style
- 2.03" hieght

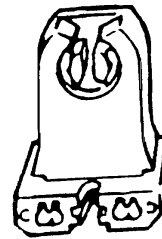

Item # M85043
U/M - Each

Item #	Mfg. No.	Description
M81006	FS-2B	15 & 20 watt fixtures
M81015	FS-4B	30 & 40 watt fixtures
M81003	FS-5B	4, 6 and 8 watt fixtures
M81018	FS-12B	32 watt circline fixtures
M81009	FS-22B	22 watt circline fixtures
M81012	FS-25B	25 watt fixtures

Stem Mouting Photo Control :



- Mfg. model no. - K4121
- 120 volts AC
- 50/60 hz
- 1800 w. tungsten
- 8.3 A. ballast

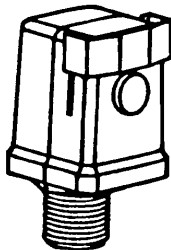

Item # M82079
U/M - Each

Fixed Position Mounting Photo Control :



- Mfg. model no. - K4321
- 120 volts AC
- 50/60 hz
- 1800 watt rating
- T-B.3 amps. blst.

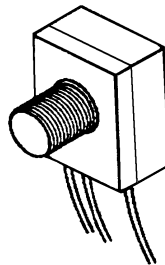

Item # M82082
U/M - Each

Socket Photo Control :



- Screws in light socket like a bulb
- For use in driveways, entrances, & patio lights
- 120 volt



Item # M82086
U/M - Each



MILL SUPPLY CO., INC.

Phone (410) 485-3343
Fax (410) 325-2240

Toll Free 1-800-817-8183

Electrical

MEDICINE CABINET DIFFUSERS

Medicine
Cabinets
Page 99

DIFFUSERS ARE SOLD
BY THE EACH

DIFFUSERS ARE ACTUAL SIZE

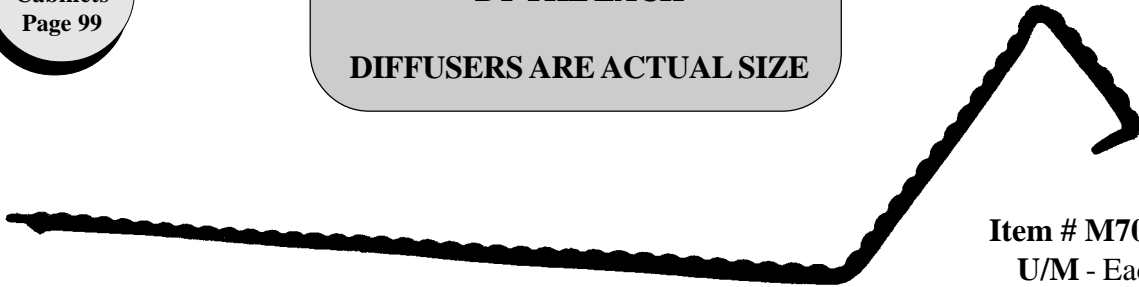

Item # M70907
U/M - Each
28-1/16" length



Item # M89023
U/M - Each
23-1/2" length



Item # M89026
U/M - Each
27-1/2" length

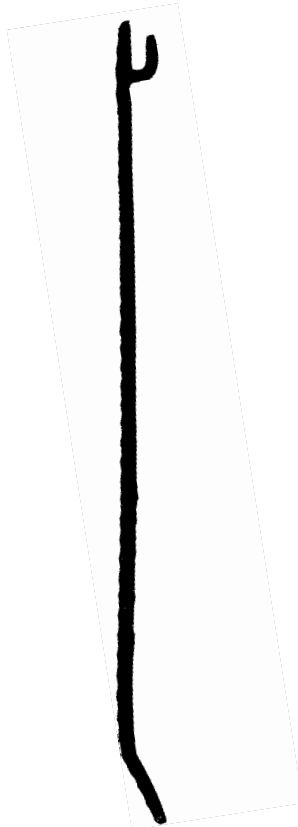

Item # M89020
U/M - Each
23-11/16" length



Item # M89018
U/M - Each
35-11/16" length



Item # M89016
U/M - Each
23-11/16" length



MILL SUPPLY CO., INC.

Phone (410) 485-3343
Fax (410) 325-2240

Toll Free 1-800-817-8183

Electrical

ELECTRICAL BOXES

Metal Switch Box :

- L type bracket, 1/2" knockouts
- 3" long x 2" wide x 2-1/2" deep
- 2 holes all 3 sides, 1 hole top and bottom

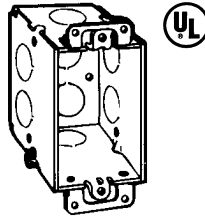

Item # M81524
U/M - Each

Metal Switch Box w/Romex Clamps :

- L type bracket
- 3" long x 2" wide x 2-1/2" deep
- Two loom or romex knockouts and 1/2" in each end
- Two 1/2" knockouts in 2 sides
- One 1/2" knockout on bottom with 10/32" deep slotted screws

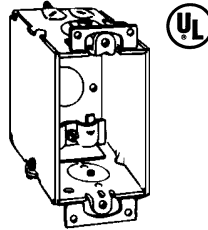

Item # M81530
U/M - Each

Metal Shallow Switch Box :

- 1-1/2" deep
- Nongangable, 3" x 2"
- 7.5 cubic inches

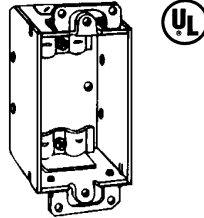

Item # M81520
U/M - Each

Metal Switch Box w/ Strap :

- 3" long x 2" wide x 2-1/2 deep
- Two loom or romex knockouts and one 1/2" in each end
- Two 1/2" knockouts in one side and bracket welded on opposite side
- One 1/2" knockout on bottom
- Clamps and 10/32" deep slotted screws included

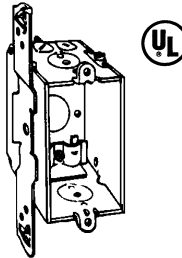

Item # M81534
U/M - Each

PVC Plastic Switch Box For Old Work:

- 2-13/16" deep
- 15 cubic inches
- Four integral clamps
- Swing Arms, ears

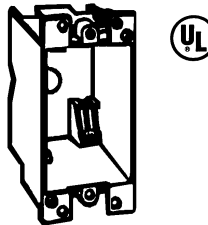

Item #	U/M	Description
M81546	Each	Single Gang
M81554	Each	Two Gang

PVC Plastic Single Gang Outlet Box :

- 18 cubic inches
- Captive nails included
- 2-1/2" deep

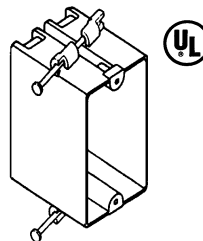

Item #	U/M	Description	Knockouts
M81542	Each	Single Gang	4
M81559	Each	Two Gang	8
M81571	Each	Three Gang	12



MILL SUPPLY CO., INC.

Phone (410) 485-3343
Fax (410) 325-2240

Toll Free 1-800-817-8183

Electrical

ELECTRICAL BOXES & ACCESSORIES

Metal Utility Box :

- 1/2" knockouts, 4" long x 2-1/8" wide
- Three 1/2" knockouts in two sides
- One 1/2" knockout in each end
- Three 1/2" knockouts and mounting holes on bottom

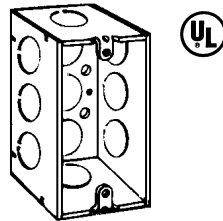

Item # M81576
U/M - Each

Metal Utility Box Switch Cover :

- Metal cover for utility box
- Screws included

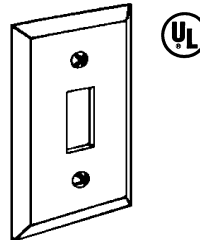

Item # M81551
U/M - Each

Metal 4" Square Outlet Box :

- Three 1/2" knockouts each side
- Five knockouts on the bottom
- Includes 8/32" x 1/2" screws

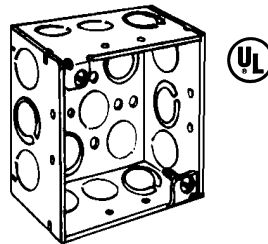

Item # M81563
U/M - Each

Metal Octagonal Outlet Box :

- 4 inch, 1-1/2" deep
- Two loom in 2 sides
- One 1/2" knockout in opposite sides
- One 1/2" knockout on bottom
- Two clamps with screws and four nail holes included

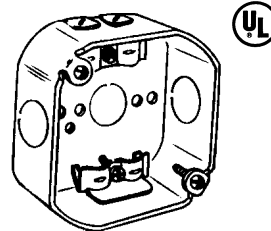

Item # M81508
U/M - Each

Metal Octagonal Outlet Box :

- 4 inch, 1-1/2" deep
- One 1/2" knockout in four sides
- Five 1/2" knockouts on bottom

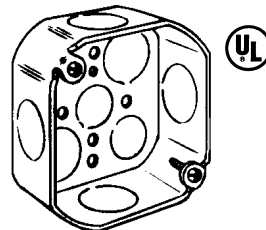

Item # M81504
U/M - Each

Wire Staples :

- 1" long x 1/2" wide
- 100 per box

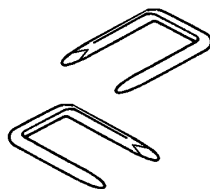

Item # M82029
U/M - Box



MILL SUPPLY CO., INC.

Phone (410) 485-3343
Fax (410) 325-2240

Toll Free 1-800-817-8183

Electrical

WEATHER PROOF DEVICES

Receptacle Cover :

- Non-metallic
- 1 gang self-closing
- For duplex receptacle, switches or combination devices

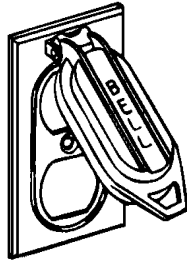

Item # M81594
U/M - Each

Outlet Box :

- 2" deep
- 1 gang box
- Gray
- Die cast aluminum
- For outside use

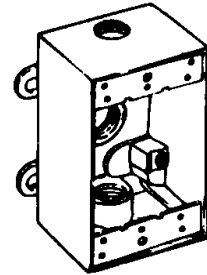

Item # M81579
U/M - Each

Rectangular Outlet Box Covers :

- 1 gang aluminum blank cover
- Gasket and screws included

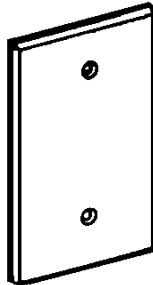

Item # M82487
U/M - Each

Octagonal Outlet Box Cover :

- 4" flat octagon

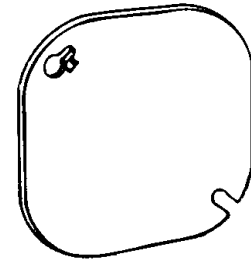

Item # M81519
U/M - Each

Square Outlet Box Cover :

- 4" flat square

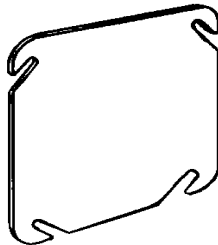

Item # M81564
U/M - Each

Switch Box Support :

- Metal
- Sold by the each

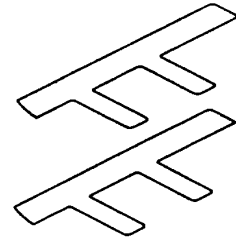

Item # M81744
U/M - Each

Lampholder :

- Standard, silver gray finish

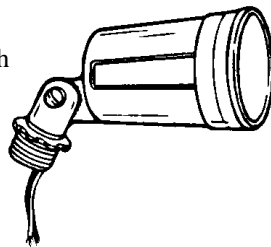

Item # M82275
U/M - Each

Lampholder Cluster :

- Covers three 1/2" holes
- Silver-gray finish

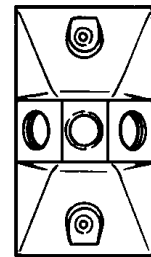

Item # M81589
U/M - Each



MILL SUPPLY CO., INC.

Phone (410) 485-3343
Fax (410) 325-2240

Toll Free 1-800-817-8183

Electrical

WIRE CONNECTORS & CABLE

Electrical Tape :

- All purpose tape
- UL listed
- Suitable for use at not more than 600 V and not more than 80 deg. C (176 deg. F)
- 3/4" x 60'



Item # M10044
U/M - Roll

3M Electrical Tape :

- Scotch Super 33+ Vinyl Electrical Tape
- UL listed. Flame retardant
- Professional quality
- Stretchy, comfortable, vinyl plastic
- Insulates and protects against abrasion, weather, water, solvent splashes, and chemicals
- 3/4" x 66'



Item # M10040
U/M - Roll

Romex Connector :

- Two screw clamp connector
- Die cast zamak
- UL file no. E52211
- For romex amored cable
- Flexible steel conduit 3/8" romex

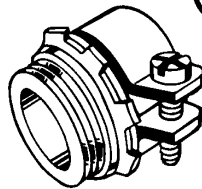

Item # M81348
U/M - Each

Wire Cable :

- Romex
- Indoor use only
- Sold by the roll

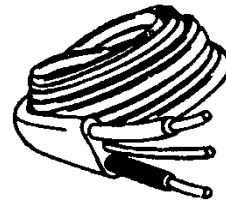

Wire
Crimper
Page 67

Item #	U/M	Length	Gauge
M81212	Roll	250'	12-2
M81224	Roll	250'	14-2

Wire Nuts :

- Sold by the box only



Item #	U/M	Size	Color
M81312	Box	Small	Gray
M81309	Box	Medium	Blue
M81304	Box	Large	Orange
M81306	Box	X-Large	Yellow
M81310	Box	Jumbo	Red

Terminal Kit :

- Contains 175 terminals and connectors
- For all electrical repairs
- Wire cutter/crimper tool is included

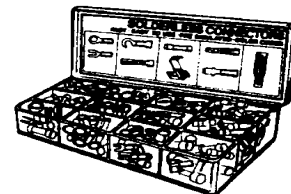

Item # M81395
U/M - Each



MILL SUPPLY CO., INC.

Phone (410) 485-3343
Fax (410) 325-2240

Toll Free 1-800-817-8183

Electrical

FIXTURES/SOCKETS/SWITCHES

Porcelain Fixture w/ Pull Chain :

- 4-1/2" Diameter
- Fits 3-1/4" or 4" box size
- 600 watts
- 250 volts

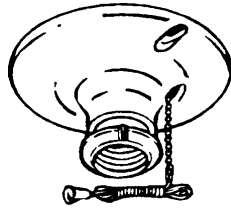

Item # M82187
U/M - Each

Keyless Porcelain Fixture :

- 4-1/2" diameter
- Fits 3-1/4" or 4" box size
- 660 watts
- 250 volts

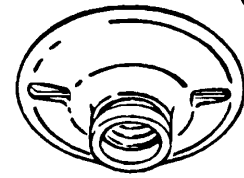

Item # M82184
U/M - Each

Interior Lamp Holder :

- Medium base
- Phenolic body
- Aluminum screw shell

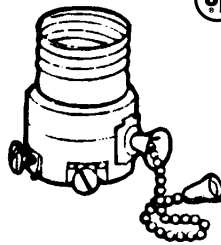

Item # M82005
U/M - Each

Twin Fixture Socket w/ 6" Leads :

- 660 watts
- 250 volts
- 18 gauge
- 105 degree leads
- 1/8" IP threads

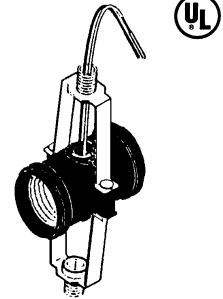

Item # M82249
U/M - Each

Single Pole Rotary Canopy Switch :

- 3A 125V, 1A 125V "T", 1A 250V
- Single pole circuit
- On/Off sequence
- Meets all UL 20 requirements

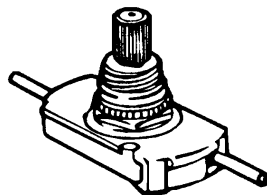

Item # M82166
U/M - Each

Compact Single Circuit Pull Chain Switch :

- 6A 125V AC, 3A 125V "T", 3A 250V AC
- Single pole circuit
- On/Off sequence
- Meets all UL 20 requirements

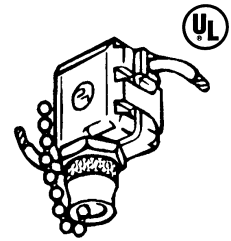

Item # M82152
U/M - Each

Toggle Switch :

- 6A 120V AC rating
- 3A 250V AC rating
- SPST circuit
- On/Off sequence
- Meets all UL 20 requirements

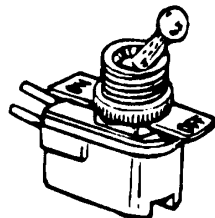

Item # M82162
U/M - Each

3-Way Switches - 2 Circuit :

- 3A 125V "T", 1A 250V
- Two circuit
- Lo-Med-Hi-Off sequence
- Meets all UL 20 requirements

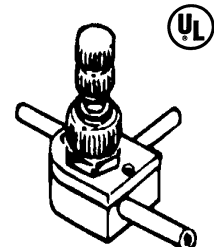

Item # M82169
U/M - Each



MILL SUPPLY CO., INC.

Phone (410) 485-3343
Fax (410) 325-2240

Toll Free 1-800-817-8183

Electrical

OUTLETS/CAPS/FIXTURE ACCESSORIES

Convenience Outlet :

- 15A, 125 volts
- 1 inch, black square
- Plastic "snap in"
- 3 wire leads

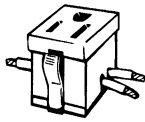

Item # M88243
U/M - Each

Convenience Outlet :

- 15A, 125 volts
- 2 wire outlet
- Plastic "snap in"
- Plastic face

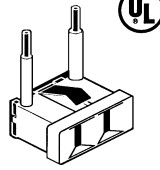

Item # M82242
U/M - Each

Surface Range Receptacle :

- 3 wire / 50 amp
- Allows for wiring from bottom or back
- Black

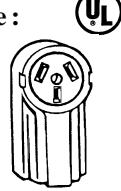

Item # M82106
U/M - Each

Surface Dryer Receptacle :

- 3 wire / 30 amp
- Allows for wiring from bottom or back
- Black

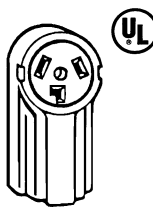

Item # M82108
U/M - Each

Surface Dryer Receptacle :

- 4 wire / 30 amp
- Allows for wiring from bottom or back
- Black

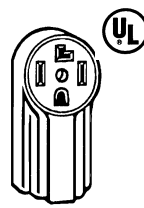

Item # M80099
U/M - Each

Surface Dryer Receptacle :

- 4 wire / 50 amp
- Allows for wiring from bottom or back
- Black

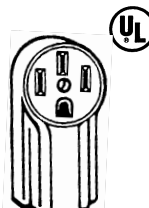

Item # M80098
U/M - Each

Grounding 3-Way Tap :

- 15 amp, 125 volts
- Heavy-duty single receptacle to 3 outlets
- Orange

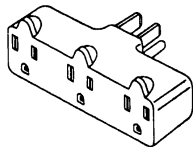

Item # M80045
U/M - Each

Female Cap :

- Black rubber
- 15 amp, 125 volts
- 2 pole, 3 wire grounding

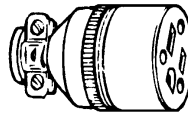

Item # M80049
U/M - Each

Male Cap :

- Black vinyl handle plug w/cord clamp
- 15 amp, 125 volts
- 2 pole, 3 wire grounding

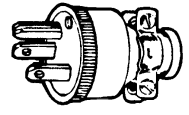

Item # M80047
U/M - Each

Grounding Adapter :

- UL listed
- 2 pole polarized to 3 wire grounding
- 15A, 125 volts

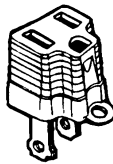

Item # M80046
U/M - Each

Jiffy Plug :

- Flat vinyl plug
- 15 amp, 125 volts
- 2 pole, 2 wire
- Brown

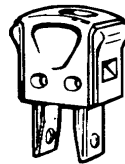

Item # M80043
U/M - Each

Jiffy Plug :

- Flat vinyl plug
- 15 amp, 125 volts
- 2 pole, 2 wire
- White

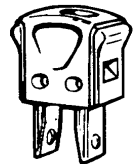

Item # M81235
U/M - Each

White Plastic Knob :

- Sold by the each



Item # M82049
U/M - Each

Pull Chain String :

- 3' with end bell and connector



Item # M82016
U/M - Each

White Plastic Candle Covers :

- Sold by the each

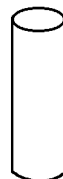

Item #	U/M	Length
M82055	Each	3"
M82056	Each	4"



MILL SUPPLY CO., INC.

Phone (410) 485-3343
Fax (410) 325-2240

Toll Free 1-800-817-8183

Electrical

TIMERS/TELEPHONE ACCESSORIES

24 Hour Timer :



- General purpose NEMA-1 enclosure
- 120 volts
- Single pole, single throw
- Includes 2 on-trippers, 2 off-trippers

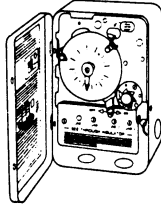

Item # M82094
U/M - Each

24 Hour Timer :



- General purpose NEMA-1 enclosure
- 120 volts
- Double pole, single throw
- Includes 2 on-trippers, 2 off-trippers

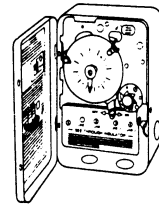

Item # M82099
U/M - Each

On/Off Switch Trippers :



- Includes 1/ea On Tripper and 1/ea Off Tripper
- Sold by the pack only

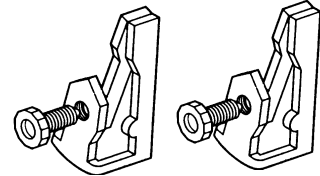

Item # M82035
U/M - Pack

Telephone Wall Jack :



- Flush rectangular
- Screws included
- Ivory

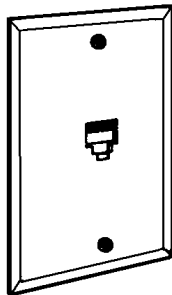

Item # M82426
U/M - Each

Telephone Wall Jack :

- Standard mount
- Screws included
- Ivory

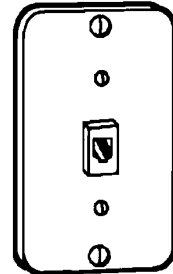

Item # M82499
U/M - Each

Telephone Wall Jack :



- Surface mount
- Screws included
- Ivory

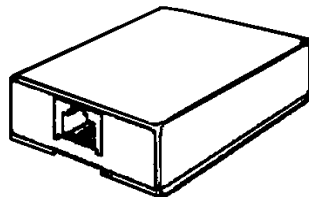

Item # M82438
U/M - Each

Wall Plate for Coaxial Cable :

- Flush mount
- Screws included
- Ivory

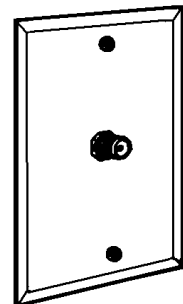

Item # M82410
U/M - Each



MILL SUPPLY CO., INC.

Phone (410) 485-3343
Fax (410) 325-2240

Toll Free 1-800-817-8183

Electrical

EXTENSION CORDS

Heavy-Duty Extension Cords :

- UL listed, 3 conductor - vinyl
- Safety orange
- Meets OSHA requirements for outdoor and indoor use



Item #	Gauge	Length
M80010	12/3	25'
M80013	14/3	25'
M80016	16/3	25'
M80019	12/3	50'
M80021	14/3	50'
M80024	16/3	50'
M80030	16/3	100'

Vinyl Cube Tap Extension Cords :

- UL listed
- Brown
- For indoor use

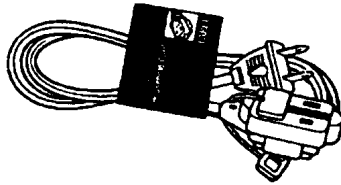

Item #	Gauge	Length
M80004	16/2	6'
M80007	16/2	12'

Dryer Cord :

- UL listed
- 30 amp
- Gray
- 3 prong



Item #	U/M	Length
M80064	Each	4'
M80068	Each	6'

Range Cord :

- UL listed
- 50 amp
- Gray
- 3 prong



Item #	U/M	Length
M80072	Each	4'
M80075	Each	6'

Range Cord :

- UL listed
- 50 amp
- Gray
- 4 prong
- 6' length



Item # M80076
U/M - Each

Trouble Light :

- UL listed
- 16/3 gauge
- 25' long cord



Item # M80052
U/M - Each



MILL SUPPLY CO., INC.

Phone (410) 485-3343
Fax (410) 325-2240

Toll Free 1-800-817-8183

Electrical

WIRING DEVICES

AC Quiet Wall Switches :



- Residential grade
- Side and back wired with ground
- Single pole, 15 amp, 120V
- CO/ALR - is for aluminum and copper wire
- CO/ALR - has no quick wire back

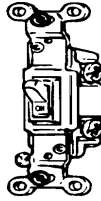

Item #	U/M	Description
M82134	Each	Single Pole Ivory
M82530	Each	Single Pole White
M82141	Each	Three-Way Ivory
M82174	Each	Single Pole Ivory (CO/ALR)
M82177	Each	Three-Way Ivory (CO/ALR)

AC Combination Switches :



- Commercial specification grade
- Single pole, 15 amp,



Item # M82136
U/M - Each

Rotary Dimmer :



- Single pole
- 600 watts
- 120 volts
- Ivory

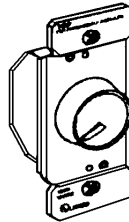

Item # M82192
U/M - Each

* Item # - M82046 Ivory Replacement Knob

AC Combination Switch and Receptacle :



- Commercial specification grade
- Single pole, 15 amp
- 120V switch
- 125V receptacle

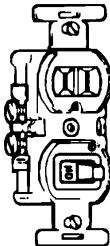

Item # M82144
U/M - Each

Duplex Receptacle :



- Residential grade
- 15 amp, 125V
- Quick wire back
- Only use #14 wire for quick wire

Item # M82149
U/M - Each

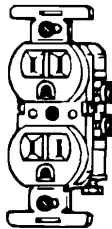

CO/ALR Duplex Receptacle :



- For aluminum & copper wire
- No quick wire back

Item # M82182
U/M - Each

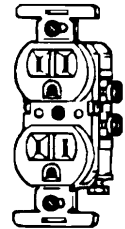

Ground Fault Interrupt (GFI) :



- 15 amp, 125V at receptacle
- 20 amp, 125V feed through
- Meets all OSHA requirements
- Includes cover plate

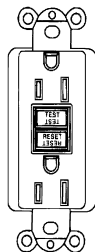

Item #	U/M	Color
M82231	Each	Ivory
M82233	Each	White



MILL SUPPLY CO., INC.

Phone (410) 485-3343
Fax (410) 325-2240

Toll Free 1-800-817-8183

Electrical

WALL PLATES

1 Gang Toggle Plate :

- Includes screws

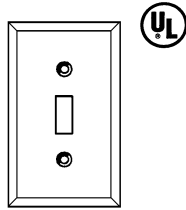

Item #	U/M	Description	Width	Height
M82530	Each	Maxi White	3-1/2"	5"
M82526	Each	Standard Ivory Wrinkle	2-3/4"	4-1/2"
M82511	Each	Maxi Ivory Wrinkle	3-1/2"	5"
M82484	Each	Jumbo Ivory Wrinkle	3-1/2"	5-1/2"
M82523	Each	Plastic Midi Ivory	3-1/4"	5"

2 Gang Toggle Plate :

- Includes screws

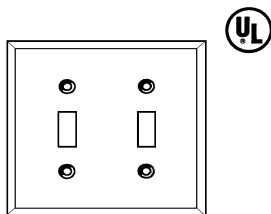

Item #	U/M	Description	Width	Height
M82622	Each	Standard White	4-9/16"	4-1/2"
M82652	Each	Standard Ivory Wrinkle	4-9/16"	4-1/2"
M82609	Each	Maxi Ivory Wrinkle	4-9/16"	5"
M82648	Each	Jumbo Ivory Wrinkle	5-1/2"	5-1/2"
M82624	Each	Plastic Midi Ivory	5-1/2"	5"

3 Gang Toggle Plate :

- Includes screws

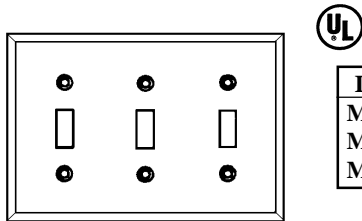

Item #	U/M	Description	Width	Height
M82831	Each	Standard White	6-3/8"	4-1/2"
M82830	Each	Maxi Ivory Wrinkle	6-3/8"	5"
M82819	Each	Jumbo Ivory Wrinkle	7-1/2"	5-1/2"

2 Gang Toggle/Duplex Plate :

- Includes screws

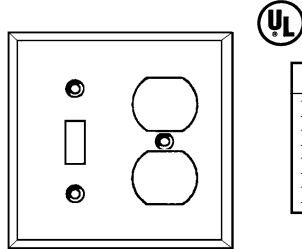

Item #	U/M	Description	Width	Height
M82640	Each	Maxi White	6-3/8"	5"
M82610	Each	Maxi Ivory Wrinkle	6-3/8"	5"
M82636	Each	Jumbo Ivory Wrinkle	7-1/2"	5-1/2"
M82616	Each	Plastic Midi Ivory	5-1/16"	5"

3 Gang Double Toggle/Duplex Plate :

- Includes screws

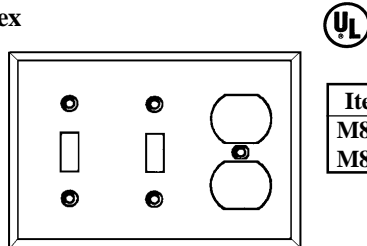

Item #	U/M	Description	Width	Height
M82825	Each	Maxi Ivory Wrinkle	6-3/8"	5"
M82804	Each	Jumbo White	7-1/2"	5-1/2"

1 Gang Duplex Plate :

- Includes screws

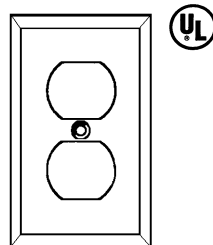

Item #	U/M	Description	Width	Height
M82532	Each	Jumbo Ivory Wrinkle	3-1/2"	5-1/2"
M82491	Each	Maxi White	3-1/2"	5"
M82493	Each	Standard Ivory Wrinkle	2-3/4"	4-1/2"
M82502	Each	Maxi Ivory Wrinkle	3-1/2"	5"
M82517	Each	Plastic Midi Ivory	3-1/4"	5"



MILL SUPPLY CO., INC.

Phone (410) 485-3343
Fax (410) 325-2240

Toll Free 1-800-817-8183

Electrical

WALL PLATES

2 Gang Duplex Plate :

- Includes screws

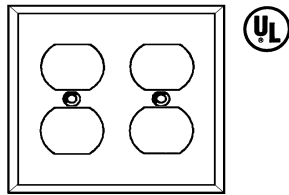

Item #	U/M	Description	Width	Height
M82606	Each	Maxi Ivory Wrinkle	6-3/8"	5"
M82632	Each	Jumbo Ivory Wrinkle	7-1/2"	5-1/2"
M82612	Each	Plastic Midi Ivory	5-1/16"	5"

1 Gang Blank Plate :

- Includes screws

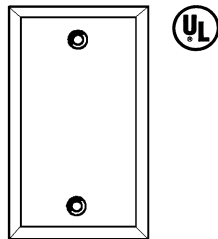

Item #	U/M	Description	Width	Height
M82496	Each	Standard Ivory Wrinkle	2-3/4"	4-1/2"
M82505	Each	Maxi Ivory Wrinkle	3-1/2"	5"
M82481	Each	Jumbo Ivory Wrinkle	3-1/2"	5-1/2"

1 Gang GFI Plate :

- Includes screws

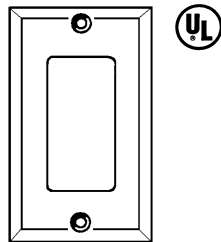

Item #	U/M	Description	Width	Height
M82508	Each	Standard Ivory Wrinkle	3-1/2"	5"
M82478	Each	Jumbo Ivory Wrinkle	3-1/2"	5-1/2"
M82520	Each	Plastic Midi Ivory	3-1/4"	5"

2 Gang GFI/Duplex Plate :

- Maxi ivory wrinkle
- Includes screws
- 6-3/8" wide x 5" long

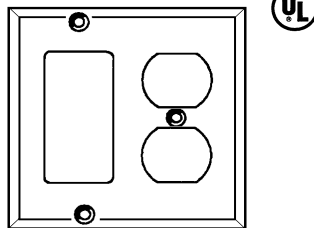

Item # M82604
U/M - Each

2 Gang GFI/Toggle Plate :

- Includes screws

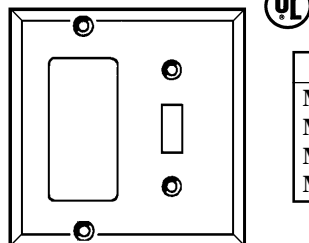

Item #	U/M	Description	Width	Height
M82607	Each	Maxi Ivory Wrinkle	6-3/8"	5"
M82614	Each	Jumbo White	7-1/2"	5-1/2"
M82644	Each	Jumbo Ivory Wrinkle	7-1/2"	5-1/2"
M82620	Each	Plastic Standard Ivory	5"	5"

3 Gang GFI/Double Toggle Plate :

- Includes screws

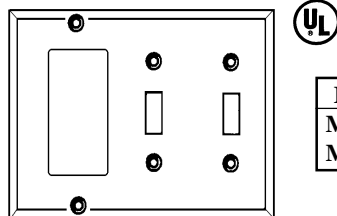

Item #	U/M	Description	Width	Height
M82801	Each	Jumbo Ivory Wrinkle	7-1/2"	5-1/2"
M82822	Each	Jumbo White	7-1/2"	5-1/2"



MILL SUPPLY CO., INC.

Phone (410) 485-3343
Fax (410) 325-2240

Toll Free 1-800-817-8183

Electrical

FUSES/CIRCUIT TESTERS/CIRCUIT BREAKERS

Glass Plug Fuse :

- Sold by the each

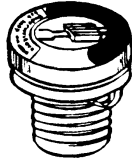

Item #	U/M	Amp
M81108	Box	15
M81118	Box	20

Plug Fuse Time Delay :

- Sold by the each

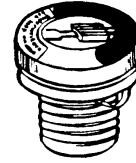

Item #	U/M	Amp
M81109	Each	15
M81127	Each	30

Circuit Tester :



- Checks for voltage from 80-500 VAC/DC
- Heavy-duty test probes on end of test leads for durability



Item # M82270
U/M - Each

Circuit Analyzer :



- Plugs into any outlet or GFI
- Reveals a light pattern to detect faulty wiring
- For use in 110-125V AC circuits



Item # M82269
U/M - Each

1lb Duct Seal :



- Seals around junction boxes & cable entries
- Non-toxic
- Paintable
- Will not corrode metal
- 1lb size

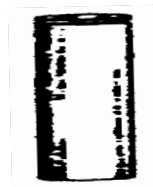

Item # M81375
U/M - Each

Circuit Breakers

Single Pole - Cutler Hammer :

- Plug in type

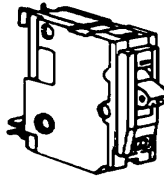

Item #	U/M	Amp
M86001	Each	15
M86002	Each	20
M86003	Each	30

Double Pole - Cutler Hammer :

- Plug in type

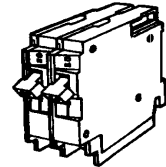

Item #	U/M	Amp
M86015	Each	15
M86016	Each	20
M86017	Each	30
M86018	Each	40
M86019	Each	50
M86020	Each	60

Square "D" Single Pole :

- Plug in type

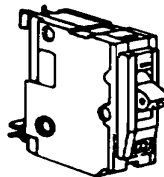

Item #	U/M	Amp
M86101	Each	15
M86102	Each	20
M86103	Each	30

Square "D" Double Pole :

- Plug in type

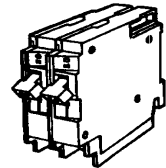

Item #	U/M	Amp
M86115	Each	15
M86116	Each	20
M86117	Each	30
M86118	Each	40
M86119	Each	50
M86120	Each	60



MILL SUPPLY CO., INC.

Phone (410) 485-3343
Fax (410) 325-2240

Toll Free 1-800-817-8183



Plumbing

Plumbing

STERLING

RAPID-FIT[®]
LSP[®]

EZ-FLO[®]

DELTA[®]
FAUCET COMPANY

Whirlaway[®]
sinkmaster

M[®]
B&K

VANCE

IN-SINK-ERATOR[®]

Olsonite[®]
SEATS

Fluidmaster

MOEN[®]

SOLDER SEAL[®]



TOTO[®]
Perfection by Design

RIDGID | Kollmann

BERNZOMATIC[®]

Kissler[®]

H JONAS HAIES
AND COMPANY, INCORPORATED



Plumbing

TUB / SHOWER REPAIR PARTS

2.5 GPM Shower Head :

- Self cleaning head adjusts from spray to rinse
- Brass ball joint
- Chrome plated
- 2.5 GPM flow

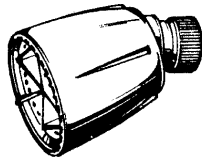

Item # M92526
U/M - Each

5.0 GPM Shower Head :

- Self cleaning head adjusts from spray to rinse
- Brass ball joint
- Chrome plated
- 5.0 GPM flow



Item # M92529
U/M - Each

ABS Shower Head :

- ABS construction
- 1-3/4" adjustable faceplate
- 1/2" inlet
- Chrome plated finish

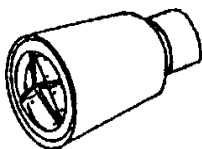

Item # M92537
U/M - Each

Water Saving Shower Head :

- Chrome plated brass
- 1/2" inlet
- Full operating ball joint

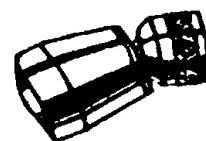

Item # M92533
U/M - Each

Shower Arms :

- Brass construction
- Chrome plated finish
- 1/2" thread on both ends



Item #	U/M	Size
M92552	Each	6"
M92554	Each	8"

Shower Arm With Flange :

- Chrome plated brass arm with 1/2" thread on both ends
- Includes chrome plated metal flange
- 8" long shower arm

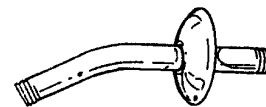

Item # M92559
U/M - Each

Shower Arm Flange :

- Fits all 1/2" shower arms
- Chrome plated finish
- Steel construction

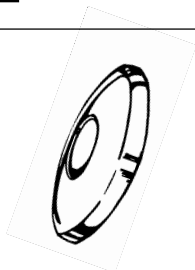

Item # M92548
U/M - Each

Shower Arm Flange With Set Screw :

- Fits all 1/2" shower arms
- ABS construction
- Chrome plated finish
- Adjustable set screw



Item # M92544
U/M - Each



MILL SUPPLY CO., INC.

Phone (410) 485-3343
Fax (410) 325-2240

Toll Free 1-800-817-8183

Plumbing

TUB / SHOWER REPAIR PARTS

Round Overflow Plate Assembly :

- Chrome plated
- Spring type
- Zinc die cast
- Screws not included



Item # M92616
U/M - Each

Round Overflow Plates :

- Chrome plated
- Zinc die cast
- Screws not included

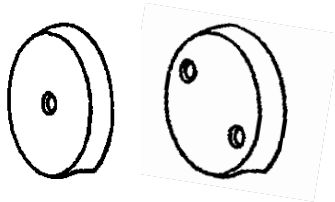

Item #	U/M	Description
M92611	Each	Single hole
M92613	Each	Double hole

Overflow Plate Screw :

- Standard size fits most overflows
- 1-1/2" x 1/4" - 20 thread
- Chrome plated



Item # M92619
U/M - Each

Overflow Washer :

- Sponge rubber fits most types
- Beveled from 9/16" to 3/16"



Item # M92620
U/M - Each

Tub Spout With Nose End Thread :

- 1/2" IPS thread at nose
- Chrome plated

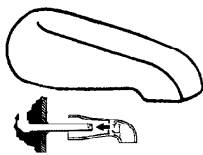

Item # M92588
U/M - Each

Diverter Spout With Nose Thread:

- 1/2" IPS threaded at nose
- Chrome plated

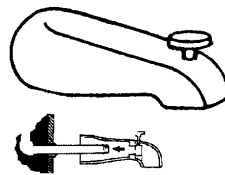

Item # M92587
U/M - Each

Slide Connector Tub Spout :

- For use on 1/2" (5/8" OD) copper pipe
- Includes set screw
- Chrome plated

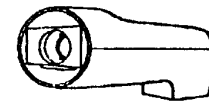

Item # M92592
U/M - Each

Slide On Diverter Tub Spout :

- For use on 1/2" (5/8" OD) copper pipe
- Includes set screw
- Chrome plated

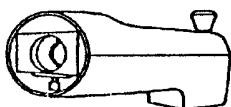

Item # M92594
U/M - Each

Diverter Spout :

- Connects to 1/2" & 3/4" IPS at wall end
- Lift in back
- Includes reducing bushing
- Chrome plated

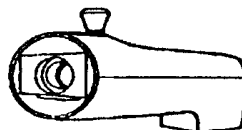

Item # M92589
U/M - Each

Diverter Spout For Personal Shower :

- Top shower adapter
- Connects to 1/2" & 3/4" IPS at wall end
- Chrome plated

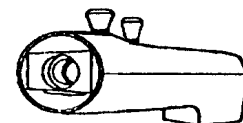

Item # M92590
U/M - Each



MILL SUPPLY CO., INC.

Phone (410) 485-3343
Fax (410) 325-2240

Toll Free 1-800-817-8183

Plumbing

TUB / SHOWER REPAIR PARTS

Tip-Toe Bath Drain Assembly :

STERLING

- No linkage to adjust, foolproof
- Drain cartridge factory installed
- Easier and quicker to install

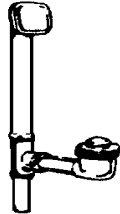

Item # M90512
U/M - Each

Tip-Toe Bath Drain w/Stopper :

- Coarse thread - 1-7/8" diameter
- 11-1/2 threads per inch
- 2-7/8" flange
- Tapped 5/16"
- Chrome plated

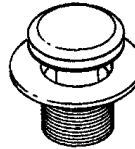

Item # M92656
U/M - Each

Cartridge For Tip-Toe Stopper :

- Coarse thread - 1-7/8" diameter
- 11-1/2 threads per inch
- 2-7/8" flange
- Tapped 5/16"
- Chrome plated

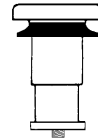

Item # M92657
U/M - Each

Toe-Touch Bath Drain Assembly Kit :

**RAPID-FIT.
LSP**

- Solid brass lift & turn
- Includes 1-1/2" - 11-1/2" adapter bushing, 1 hole plate, screw, and adapter bar
- Fits virtually all bath wastes now in service
- Chrome finish

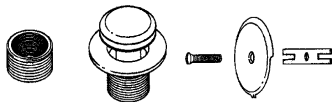

Item # M92629
U/M - Each

Toe-Touch Tub Stoppers :

**RAPID-FIT.
LSP**

- Activated by rubber boot
- No springs to wear out
- The original and most trouble-free toe-touch stopper in the industry
- Chrome finish

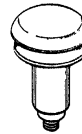

Item #	U/M	Screw Size	Height
M92631	Each	3/8"	2-3/16"
M92633	Each	5/16"	2-3/16"
M92636	Each	3/8"	1-15/16"

Twist & Turn Tub Stopper :

- Coarse thread
- 1-7/8" diameter - 11-1/2 threads per inch
- Chrome finish
- 2-7/8" flange

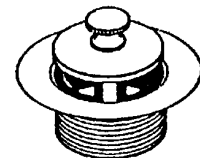

Item # M92627
U/M - Each

Twist & Turn Replacement Stopper :

**RAPID-FIT.
LSP**

- Includes reversible 3/8" and 5/16" stem
- Allows theft-resistant installations
- Fits virtually all non-trip lever strainers
- Chrome plated



Item # M92626
U/M - Each

Flip-It Tub Stopper :

- ABS & Delrin 1 pc. construction
- No tools needed for installation
- Fits most tub drains
- Flip to close or open with a simple flip of the top
- Chrome finish

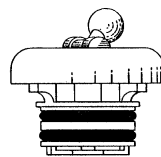

Item # M92632
U/M - Each

PVC Waste & Overflow Assembly :

- Adjusts to fit most bathtubs
- Chrome plated trim
- 1-1/2" drain
- Plastic strainer
- Trip lever style

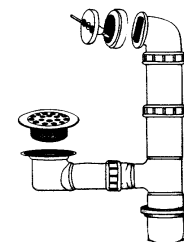

Item # M92751
U/M - Each



MILL SUPPLY CO., INC.

Phone (410) 485-3343
Fax (410) 325-2240

Toll Free 1-800-817-8183

Plumbing

TUB / SHOWER REPAIR PARTS

Bath Drain Linkage

Assembly :

- Linkage assembly includes pin
- Universal fit all



Item # M92609

U/M - Each

Brass Bucket Assembly :

- Replacement for trip-lever style waste & overflow
- Includes pin
- Universal fit all



Item # M92677

U/M - Each

Tub Shoe :

- 1-1/2" tubular outlet
- Coarse thread: accepts (1-7/8" x 11-1/2) threads per inch bath strainers
- Brass

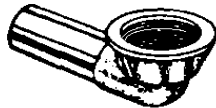

Item # M92676

U/M - Each

Tub Shoe Washer :

- Flat rubber
- 1-3/4" I.D., 2-5/8" O.D., 3/32" Thick



Item # M92675

U/M - Each

3-Prong Drain

Protectors :

- Stainless Steel

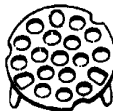

Item #	U/M	Size
M91217	Each	1-5/8"
M91220	Each	1-7/8"

Shower Drain Grid :

- Snap-in type
- Fits most 4-1/2" shower stall drains
- Stainless steel

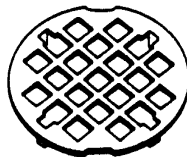

Item # M92701

U/M - Each

Shower Drain :

- Quick caulking
- Use on steel, fiberglass and plastic shower bases
- Internal compression sealing gasket
- Fits 2" schedule 40, steel or plastic pipe
- No solvent or lead required
- PVC body, stainless steel grid



Item # M92705

U/M - Each

Tub Stopper :

- Fits 1-1/2" to 2" openings
- White rubber

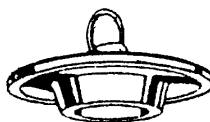

Item # M91213

U/M - Each



MILL SUPPLY CO., INC.

Phone (410) 485-3343

Fax (410) 325-2240

Toll Free 1-800-817-8183

Plumbing

TUB / SHOWER REPAIR

Straight Shower Rods :

- 1" diameter
- Polished aluminum
- Does not include flange



Item #	U/M	Size
M92515	Each	5'
M92516	Each	6'

Adjustable Shower

Rod Flange :

- Rubber pads will not mark or deface any surface
- Just turn to tighten against wall
- Made of highly durable ABS
- Chrome plated finish

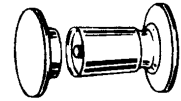

Item # M92503

U/M - Each

Round Shower

Rod Flange :

- Fits 1" O.D. rod
- Chrome plated with screws
- Exposed screw type
- Sold by the pair



Item # M92502

U/M - Pair

Rectangular Shower

Rod Flange :

- Fits 1" O.D. rod
- Chrome plated with screws
- Sold by the each

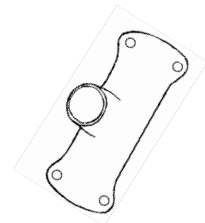

Item # M92505

U/M - Each

Spraymaids : [®]

- Easy do-it-yourself installation
- Keeps water inside of bath tub and shower curtain
- Protects walls, floor, and carpets from water damage
- 48" high x 4-1/2" wide
- Sold by the pair
- White

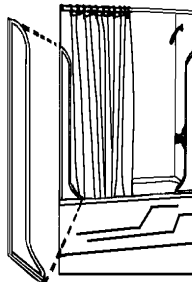

Item # M96024

U/M - Pair

Mini-Spraymaids : [®]

- Easy do-it-yourself installation
- Keeps water inside bath tub and shower curtain
- Protects walls, floor, and carpets from water damage
- 7" high x 7" wide
- Sold by the pair
- White



Item # M96012

U/M - Pair

Deluxe Tub Surround :

- Installs quickly and easily over most solid surfaces including tile
- Five precision molded panels adjust to fit most popular tubs
- Five panels are precision molded of high strength copolymer material for excellent durability
- White

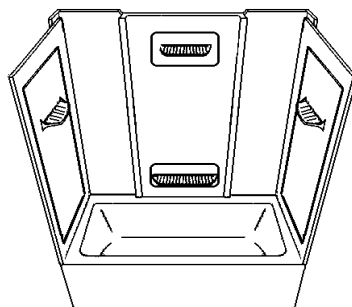

Item # M97615

U/M - Each

Shower Surround :

- Includes two corner shelf units with built in towel bars and three flat panels
- Easy to clean high gloss finish resists mold and mildew
- Specially designed for easy install over most solid surfaces including ceramic tile
- White

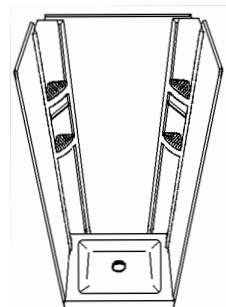

Item # M97605

U/M - Each

Shower
Doors
Page 115 &
116



MILL SUPPLY CO., INC.

Phone (410) 485-3343
Fax (410) 325-2240

Toll Free 1-800-817-8183

Page 265

Plumbing

Plumbing

FAUCET / SINK REPAIR

Dual Thread Aerator :

- 15/16" outside thread and 55/64" inside thread
- Fits most applications
- 2.0 GPM flow
- Plastic restrictor
- Chrome plated



Item # M91058

U/M - Each

Female Aerator :

- Chrome plated brass
- With flow restrictors
- 3/4" x 27 threads
- 2.0 GPM flow



Item # M91062

U/M - Each

Swivel Spray Aerator :

- Standard dual-thread design fits most faucets
- Swivels a full 360 to cover the entire sink



Item # M91060

U/M - Each

Aerator Adaptor :

- C.P. brass with washer
- Standard dual thread
- Connects to male garden hose

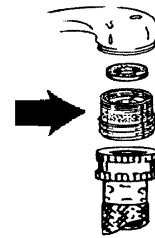

Item # M91064

U/M - Each

Faucet Lock Nut :

- 1/2" IPS
- Die cast

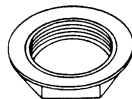

Item # M97404

U/M - Each

Faucet Coupling Nuts :

- 7/8" ballcock thread
- 1/2" IPS hole

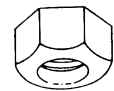

Brass

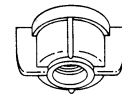

Plastic

Item #	U/M	Type
M97412	Each	Brass
M91066	Each	Plastic

Basin Rosette :

- Used as a washer between basin and lock nut
- Sold per each

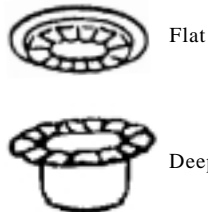

Flat

Deep

Item #	U/M	Type
M91069	Each	Flat
M91068	Each	Deep

Hose & Spray Set :

- Includes spray head, hose, and guide

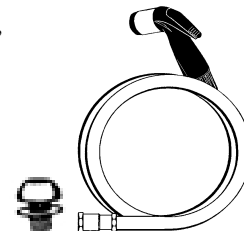

Item #	U/M	Description
M91286	Each	Spray Head Only
M91288	Each	Complete Set



MILL SUPPLY CO., INC.

Phone (410) 485-3343
Fax (410) 325-2240

Toll Free 1-800-817-8183

Plumbing

FAUCET / SINK REPAIR

Sink Hole Covers :

- Chrome plated



Standard



Snap-In

Item #	U/M	Size / Type
M91251	Each	1-3/4" Standard cover
M91255	Each	1-1/2" Snap-In cover

Basket Strainer Assembly :

- Stainless steel duo basket strainer
- Fits 3-1/2" - 4" sink openings
- Stick post basket
- With die cast nuts

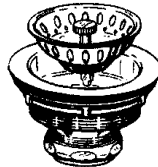

Item # M91232
U/M - Each

Fit-All Basket Strainer :

- Stainless Steel
- Adjustable post
- Chrome plated



Item # M91212
U/M - Each

Sink Strainer Basket :

- Stainless steel
- Fixed post
- Chrome plated



Item # M91226
U/M - Each

Crumb Cups :

- Less post
- Chrome plated



Item #	U/M	Size / Type
M90615	Each	1" - Basin
M90616	Each	1-1/2" - Sink

Garbage Disposal Strainer :

- Keeps drain open while working at sink and stops any solid or valuable objects from falling into garbage disposal
- Fits most garbage disposals

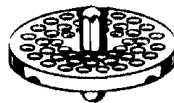

Item # M91223
U/M - Each

Drain Protector :

- Aluminum
- 3-1/16" clip on bottom

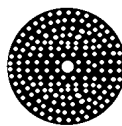

Item # M91214
U/M - Each



MILL SUPPLY CO., INC.

Phone (410) 485-3343
Fax (410) 325-2240

Toll Free 1-800-817-8183

Plumbing

FAUCET / SINK REPAIR

Whirlaway Splash Guard and Stopper :

- Splash guard 3-1/4" OD
- New style stopper 2-1/2" ID
- Sold by the set

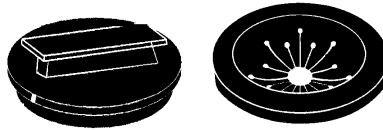

Item # M91200
U/M - Set

Whirlaway Stopper :

- Black plastic
- New style 2-1/2" ID
- Sold by the each

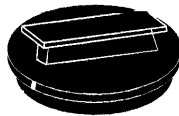

Item # M91203
U/M - Each

In-Sink-Erator Stopper :

- Stopper for ISE disposal units
- Black plastic



Item # M91092
U/M - Each

In-Sink-Erator Splash Guard :

- Baffle for ISE disposal units
- Black Rubber



Item # M97524
U/M - Each

Garbage Disposal Splash Guard :

- Fit-all replacement for most disposals
- With snap ring for holding in place

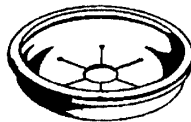

Item # M91089
U/M - Each

Fit-All Disposal Stopper :

- Vinyl, with knobs
- Flanged to fit all sizes
- Designed with stay-put lip to prevent slipping and can be used in basket strainers and garbage disposals



Item # M91086
U/M - Each

Fit-All Basin Stopper :

- Basin stopper fits 1" to 1-3/8"
- White rubber

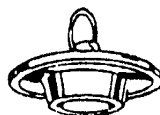

Item # M91211
U/M - Each



Plumbing

DISPOSALS & REPAIR PARTS

Garbage Disposals :

- Quick lock mounting makes installation a snap
- Designed for apartment use
- Continuous feed
- All mounting hardware included
- 1 year warranty

IN-SINK-ERATOR

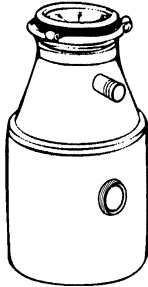

Item #	U/M	HP
M97502	Each	1/3- Fwd
M97503	Each	1/2 -Fwd2

Garbage Disposal :

- Stainless steel, anti-jam swivel impellers
- Corrosion-proof grinding chamber
- Plumb E-Z mounting system
- All mounting hardware included
- 1/3 Horsepower
- 2 Year warranty

Whirlaway
sinkmaster

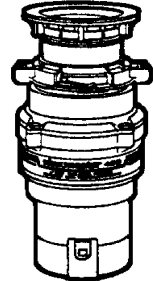

Item # M97527
U/M - Each

Garbage Disposal Waste Arms :

- 1-1/2" x 2-1/4" plastic
- Fits ISE and various others

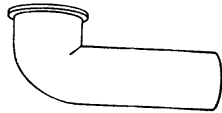

Item #	U/M	Elbow/Size
M93694	Each	4"
M93695	Each	7"

Brass Garbage Disposal Waste Arm :

- 1-1/2" x 2-1/2" x 8" brass
- Fits various types

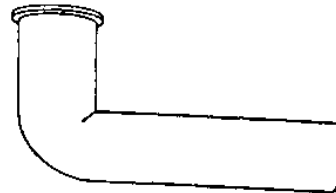

Item # M97102
U/M - Each

Disposal Seal :

- For connecting waste arm to disposal
- Fits ISE
- Rubber
- Black

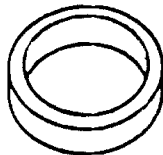

Item # M91278
U/M - Each

Garbage Disposal Clearing Wrench :

- Frees jammed disposal blades without endangering hands
- For ISE disposals

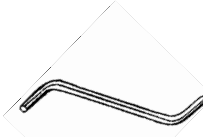

Item # M99012
U/M - Each

Garbage Disposal Clearing Wrench :

- Frees jammed disposal blades without endangering hands

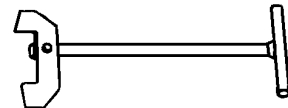

Item # M99011
U/M - Each



MILL SUPPLY CO., INC.

Phone (410) 485-3343
Fax (410) 325-2240

Toll Free 1-800-817-8183

Plumbing

DISPOSAL REPAIR PARTS / HOSE

Disposal Dishwasher Air Gap :

- Prevents waste from backing up
- Plastic body

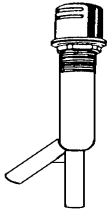

Item # M91275
U/M - Each

Disposal Dishwasher Air Gap :

**EASTMAN
SPEED-FLEX™**

- Prevents waste from backing up
- Premium quality
- Plastic body

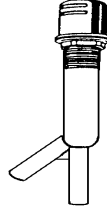

Item # M91274
U/M - Each

Airgap Cleaning Tool :

- Eliminates the need to replace clogged air gap
- Just remove cap from air gap and run the tool through the line
- Allows easy repairs to be done in minutes
- Sold per each

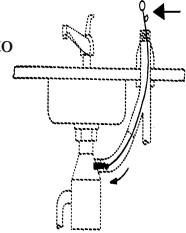

Item # M91276
U/M - Each

Air Gap Replacement Cap :

- Chrome plated
- Fits most air gaps

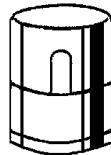

Item # M91266
U/M - Each

Dishwasher-Disposal Connector/Boot :

- Makes a quick and positive seal between drain and disposal
- Includes four clamps for easy installation

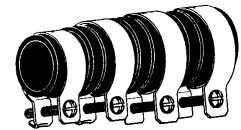

Item # M91279
U/M - Each

Dishwasher Drain Hose :

- Hot water hose
- 50ft. coils
- Rubber hose

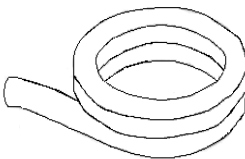

Item #	U/M	Size
M91953	Each	5/8" I.D.
M91964	Each	7/8" I.D.

Washing Machine Hose - Rubber :

- 3/8" black high-pressure hose
- 200 PSI working 800PSI burst pressure
- Female x female hose thread couplings

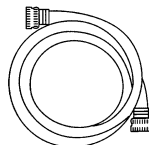

Item #	U/M	Size
M96510	Each	5'
M96520	Each	6'

Washing Machine Hose - Stainless Steel :

- 3/8" braided high-pressure hose
- 400 PSI working 2000PSI burst pressure
- Female x female hose thread

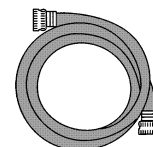

Item #	U/M	Size
M96553	Each	4'
M96559	Each	5'
M96562	Each	6'



Plumbing

WATER SUPPLY

Flexible Supply Lines :

- 3/8" OD polyethylene tubing (PEX)
- With plastic sleeve



Lavatory



Closet

Item #	U/M	Type	Size
M99203	Each	Lavatory	3/8" x 12"
M99205	Each	Lavatory	3/8" x 20"
M99216	Each	Closet	3/8" x 12"
M99218	Each	Closet	3/8" x 20"

Flexible Sink Supply Lines :

- 3/8" compression x 1/2" IPS

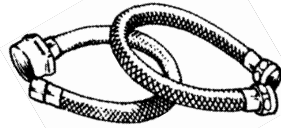

Item #	U/M	Type	Size
M99303	Each	Stainless Steel	12"
M99305	Each	Stainless Steel	20"
M99253	Each	Nylon	12"
M99255	Each	Nylon	20"

Flexible Tank Supply Lines :

- 3/8" compression x 7/8" ballcock nut



Item #	U/M	Type	Size
M99317	Each	Stainless Steel	9"
M99318	Each	Stainless Steel	12"
M99273	Each	Nylon	12"
M99275	Each	Nylon	20"

Lavatory Riser :

- Chrome plated copper
- NSF listed
- 3/8" OD x 12"
- For use on faucets

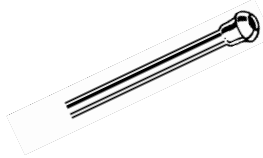

Item # M99292
U/M - Each

Copper Sweat Inlet x Copper Comp. Outlet :

- 1/2 Nom. Sweat x 3/8" OD compression outlet
- Angled
- For connection to wall nipple
- Chrome plated

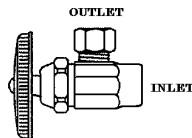

Item # M99933
U/M - Each

Copper Comp. Inlet x Copper Comp. Outlet :

- 1/2 Nom. compression x 3/8" OD compression outlet
- Angled
- For connection to wall nipple
- Chrome plated

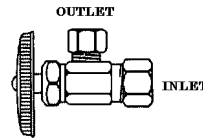

Item # M99924
U/M - Each

Copper Comp. Inlet x Copper Comp. Outlet :

- 1/2 Nom. compression x 3/8" OD compression outlet
- Straight
- For connection to floor nipple
- Chrome plated

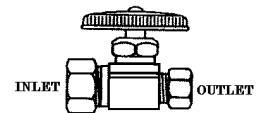

Item # M99936
U/M - Each

Closet Riser :

- Chrome plated copper
- NSF listed
- 3/8" OD x 12"
- For use on toilets

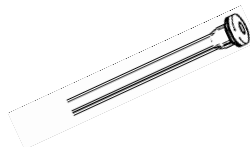

Item # M99297
U/M - Each

IPS Inlet x Copper Comp. Outlets :

- Angled
- For connection to wall nipple
- Chrome plated

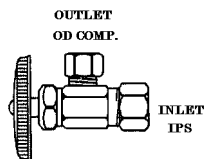

Item #	U/M	Size	I x O
M99921	Each	3/8 IPS x 3/8 OD	
M99923	Each	1/2 IPS x 3/8 OD	

IPS Inlet x Copper Comp. Outlets :

- Straight
- For connection to floor nipple
- Chrome plated

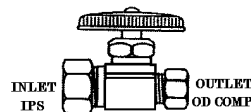

Item #	U/M	Size	I x O
M99925	Each	3/8 IPS x 3/8 OD	
M99928	Each	1/2 IPS x 3/8 OD	

Dual Outlet Valves Copper Comp. Inlet x Copper Comp. Outlets :

- Rough brass
- Chrome plated

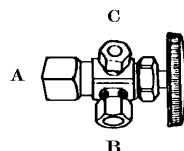

Item #	U/M	Size	A x B x C
M99911	Each	1/2" x 3/8" x 1/4"	
M99914	Each	1/2" x 3/8" x 3/8"	



MILL SUPPLY CO., INC.

Phone (410) 485-3343
Fax (410) 325-2240

Toll Free 1-800-817-8183

Plumbing

WATER SUPPLY

Union Female :

- #66
- Compression x Female Pipe Thread
- Brass



Item #	U/M	O.D. Tube x FPS
M95745	Each	1/4" x 1/8"
M95746	Each	1/4" x 3/8"
M95747	Each	3/8" x 1/4"
M95748	Each	3/8" x 3/8"
M95756	Each	3/8" x 1/2"
M95757	Each	1/2" x 3/8"
M95758	Each	1/2" x 1/2"
M95759	Each	5/8" x 1/2"

Union Male :

- #68
- Compression x Male Pipe Thread
- Brass



Item #	U/M	O.D. Tube x MPS
M95760	Each	1/4" x 1/8"
M95761	Each	1/4" x 1/4"
M95762	Each	3/8" x 1/4"
M95763	Each	3/8" x 3/8"
M95764	Each	3/8" x 1/2"
M95765	Each	1/2" x 3/8"
M95766	Each	1/2" x 1/2"
M95767	Each	5/8" x 3/8"
M95780	Each	5/8" x 1/2"
M95782	Each	5/8" x 3/4"
M95783	Each	7/8" x 3/4"

Union

(Tube Both Ends) :

- #62
- Compression x Compression
- Brass



Item #	U/M	O.D. Tube
M95604	Each	1/4"
M95620	Each	3/8"
M95628	Each	1/2"
M95636	Each	5/8"
M95644	Each	7/8"

Elbow Male :

- #69
- Compression x Male Pipe Thread
- Brass

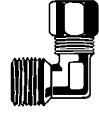

Item #	U/M	O.D. Tube x MPS
M95785	Each	1/4" x 1/8"
M95786	Each	1/4" x 1/4"
M95787	Each	3/8" x 1/4"
M95788	Each	3/8" x 3/8"
M95799	Each	3/8" x 1/2"
M95800	Each	1/2" x 1/4"
M95804	Each	1/2" x 3/8"
M95812	Each	1/2" x 1/2"
M95828	Each	5/8" x 1/2"
M95820	Each	5/8" x 3/8"

Reducing Union (Tube Both Ends) :

- #62R
- Compression x Compression
- Brass



Item #	U/M	O.D. Tube
M95652	Each	3/8" x 1/4"
M95653	Each	3/8" x 5/16"
M95660	Each	1/2" x 3/8"
M95668	Each	5/8" x 3/8"
M95676	Each	5/8" x 1/2"

Elbow (Tube Both Ends) :

- #65
- Compression x Compression
- Brass

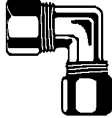

Item #	U/M	O.D. Tube
M95691	Each	1/4"
M95692	Each	3/8"
M95700	Each	1/2"
M95708	Each	5/8"

Tee (Tubing All 3 Ends) :

- #64
- Compression Three Ends
- Brass

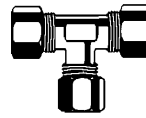

Item #	U/M	O.D. Tube
M95683	Each	1/4"
M95684	Each	3/8"
M95686	Each	1/2"
M95687	Each	5/8"

Compression Nut :

- #61
- Brass



Item #	U/M	Size
M95556	Each	1/8"
M95564	Each	1/4"
M95580	Each	3/8"
M95588	Each	1/2"
M95592	Each	5/8"

Compression Sleeve :

- #60
- Brass



Item #	U/M	O.D. Tube
M95516	Each	1/8"
M95524	Each	1/4"
M95532	Each	3/8"
M95540	Each	1/2"
M95541	Each	5/8"

Compression Sleeve :

- 3/8" OD
- Plastic
- For use with PEX tubing



Item # M99231
U/M - Each

Chrome Plated Nipple :

- 3/8" x 6"

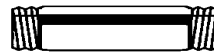

Item # M96922
U/M - Each

Needle Valve Kit :

- Self tapping for 3/8" to 1" tubing
- Perfect for icemakers

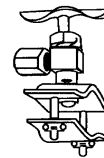

Item # M99764
U/M - Each



Plumbing

TUBULAR BRASS

J-Bends :

- Chrome plated brass
- Inlet and outlet are both threaded for slip nuts
- Both connections slip joint
- 20 gauge

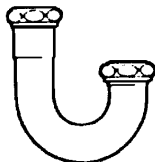

Item #	U/M	Size
M97021	Each	1-1/4"
M97027	Each	1-1/2"

J-Bend For Sink Trap :

- Chrome plated brass
- Slip connection inlet
- Outlet has direct flange connection
- 20 gauge

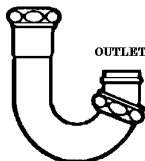

Item #	U/M	Size
M97030	Each	1-1/4"
M97033	Each	1-1/2"

P-Traps :

- Chrome plated brass
- 20 Gauge

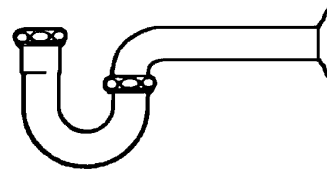

Item #	U/M	Size
M97003	Each	1-1/4"
M97006	Each	1-1/2"

Wall Bends :

- 9" chrome plated brass
- 22 gauge

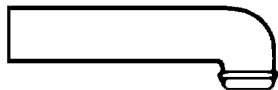

Item #	U/M	Size
M97035	Each	1-1/4"
M97036	Each	1-1/2"

Quick Repair Traps :

- Chrome plated
- 20 gauge
- Slip joint connection on both ends

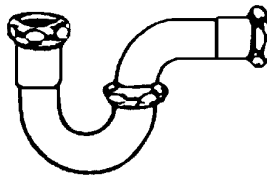

Item #	U/M	Size
M97009	Each	1-1/4"
M97015	Each	1-1/2"

Straight Tailpieces :

- Chrome plated brass
- 22 gauge

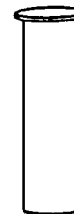

Item #	U/M	Size
M97060	Each	1-1/2" x 8"
M97063	Each	1-1/2" x 12"

PO Plug :

- Chrome plated brass with rubber stopper and chain
- 1-1/4" x 5"

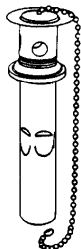

Item # M91298
U/M - Each

Slip Joint Extension Tubes :

- Chrome plated brass
- 22 gauge



Item #	U/M	Size
M97075	Each	1-1/4" x 8"
M97078	Each	1-1/4" x 12"
M97081	Each	1-1/2" x 8"
M97084	Each	1-1/2" x 12"

Threaded Tubes :

- Chrome plated brass
- 20 gauge

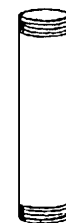

Item #	U/M	Size
M97106	Each	1-1/4" x 12"
M97108	Each	1-1/2" x 12"



MILL SUPPLY CO., INC.

Phone (410) 485-3343
Fax (410) 325-2240

Toll Free 1-800-817-8183

Plumbing

TUBULAR BRASS

Extension Tubes :

- Chrome plated brass
- 17 gauge



Item #	U/M	Size
M97067	Each	1-1/2" x 8"
M97069	Each	1-1/2" x 12"

Slip Joint Waste Arms :

- Chrome plated brass, 1-1/2"
- 20 gauge

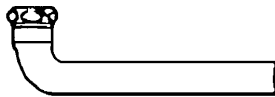

Item #	U/M	Size
M97120	Each	9-1/2"
M97132	Each	15"

Direct Connection Waste Arms :

- Chrome plated brass, 1-1/2"
- 20 gauge

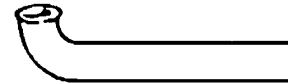

Item #	U/M	Size
M97111	Each	9-1/2"
M97129	Each	15"

Double Slip Extension Couplings :

- Chrome plated brass



Item #	U/M	Size
M97087	Each	1-1/4"
M97090	Each	1-1/2"

Cast Elbows :

- Chrome plated
- 20 gauge
- Threaded

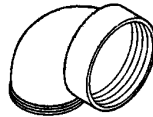

Item #	U/M	Size
M97096	Each	1-1/4"
M97099	Each	1-1/2"

90 Degree Slip Elbow :

- Chrome plated brass

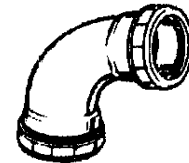

Item #	U/M	Size
M97092	Each	1-1/4"
M97094	Each	1-1/2"

45 Degree Slip Elbow :

- Chrome plated brass



Item #	U/M	Size
M97093	Each	1-1/4"
M97095	Each	1-1/2"

Dishwasher Branch Tailpieces :

- For 3/4" sweat (7/8" OD) or hose clamp
- 8" Satin finish
- Direct connect inlet

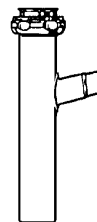

Item # M97050
U/M - Each

Threaded Dishwasher Branch Tailpiece :

- For 3/4" sweat (7/8" OD) or hose clamp
- 8" Satin finish
- Slip joint nut down inlet

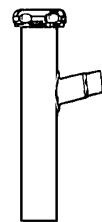

Item # M97049
U/M - Each



Plumbing

TUBULAR BRASS ACCESSORIES

Slip Joint Nuts :

- Chrome plated

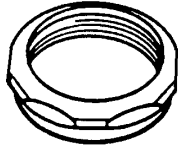

Item #	U/M	IPS	ID
M97153	Each	1-1/4"	1-1/4"
M97159	Each	1-1/2"	1-1/4"
M97155	Each	1-1/2"	1-1/2"
M97157	Each	2"	2"

Ground Joint Connectors :

- Trap tube x outlet
- Straight female iron pipe

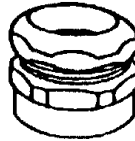

Item #	U/M	O.D.	Female IPS
M97355	Each	1-1/4"	1-1/2"
M97356	Each	1-1/2"	1-1/2"

Ground Joint Connectors :

- Trap tube x outlet
- Straight male IPS
- Tapped female copper sweat
- 1-1/2" OD x 1-1/2" MIP

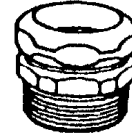

Item # M97353
U/M - Each

Tubular Drain Pipe Connector :

- Connects any combination of 1-1/2" or 1-1/4" brass or plastic drain pipe

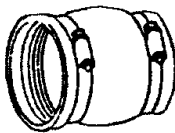

Item # M93459
U/M - Each

Flexible Drain And Trap Connectors :

- Connects 1-1/4" or 1-1/2" tubular traps to drain pipe, except copper

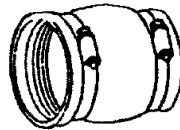

Item #	U/M	Pipe size
M93474	Each	2"
M93456	Each	1-1/2"

Flexible Couplings :

- Connects any combination of cast iron, plastic, copper, steel or lead.

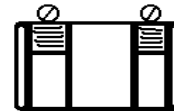

Item #	U/M	Size
M93465	Each	1-1/2" x 1-1/2"
M93453	Each	1-1/4" x 1-1/4"
M93462	Each	1-1/2" x 1-1/4"
M93471	Each	2" x 2"

Slip Joint Washers :

- Black rubber

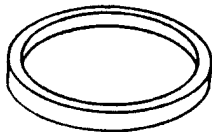

Item #	U/M	ID	OD	Thick
M97162	Each	1-1/4"	1-1/2"	3/16"
M97164	Each	1-1/2"	1-3/4"	3/16"
M97180	Each	1-7/32"	1-23/32"	3/16"

Polyethylene Washers :

- White plastic

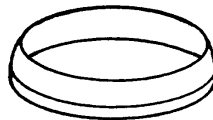

Item #	U/M	Size
M97174	Each	1-1/4"
M97176	Each	1-1/2"
M97178	Each	1-1/2" x 1-1/4"

Sink Connection Washer :

- Flanged white plastic
- 1-23/32" OD,
1-5/16" ID

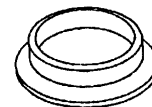

Item # M97183
U/M - Each

Basin Mack Gasket :

- 1-1/4" ID, 2" OD
- Black rubber

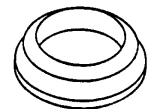

Item # M92166
U/M - Each



MILL SUPPLY CO., INC.

Phone (410) 485-3343
Fax (410) 325-2240

Toll Free 1-800-817-8183

Plumbing

SINKS

Stainless Steel Kitchen Sink :

- Durable buffed finish
- Sound deadened
- 25" x 22"
- 4 Hole / 6-1/2" Deep
- Includes mounting clips

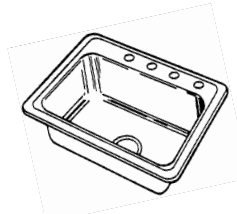

Item # M90203
U/M - Each

Kitchen Sink Clips :

- Fits most stainless steel sinks
- Sold per pack of 10 only

Item # M90253
U/M - Pack

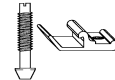

Single Laundry Tub Sink :

- For workshop, laundry room, etc.
- One piece construction. heavy gauge, snap-in plastic legs
- Built-in self draining system

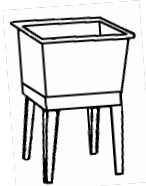

Item # M90178
U/M - Each

18" Round Porcelain Lavatory Sink :

- Under counter type
- Acid resistant porcelain on steel, for a 4" centerset faucet
- Rimless
- White



Item # M90226
U/M - Each

19" Round Porcelain Lavatory Sink :

- Acid resistant porcelain on steel, for a 4" centerset faucet
- Installation clamps included
- Self rimming
- White



Item # M90231
U/M - Each

19" x 16" Oval Porcelain Lavatory Sink :

- Under counter type
- Rimless
- Acid resistant porcelain on steel for a 4" centerset faucet
- White



Item # M90245
U/M - Each

20" x 17" Oval Porcelain Lavatory Sink :

- Acid resistant porcelain on steel, for a 4" centerset faucet
- Installation clamps included
- Self rimming
- White



Item # M90236
U/M - Each

Wall Hung Lavatory Sink :

- White
- 19" x 17" Acid resisting
- Extra large bowl
- Drilled for 4" faucet

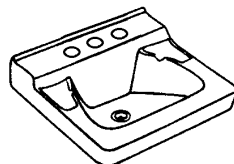

Item # M90232
U/M - Each

Lavatory Legs :

- Easy to install
- Chrome plated
- Sold by the pair
- 2-1/2" long

Item # M90184
U/M - Pair



MILL SUPPLY CO., INC.

Phone (410) 485-3343
Fax (410) 325-2240

Toll Free 1-800-817-8183

Plumbing

SINK RIMS / VANITYS / ICE CUBE TRAYS

Round Sink Rim :

- Stainless steel
- Includes all mounting hardware
- For 18" round sinks

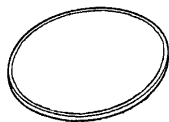

Item # M90272
U/M - Each

Oval Sink Rim :

- Stainless steel
- Includes all mounting hardware
- For 19" x 16" oval sinks

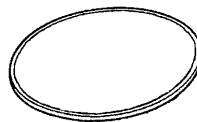

Item # M90274
U/M - Each

Ice Cube Tray :

- Made of durable plastic
- 2 per pack

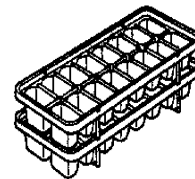

Item # M76501
U/M - Pack

Vanity Top :

- Made of fine cultured marble
- White on white color
- Recessed oval bowl style
- Accepts 4" centerset standard lavatory faucets

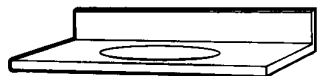

Item #	U/M	Size
M76276	Each	25" x 22"
M76280	Each	28" x 22"
M76289	Each	31" x 22"
M76302	Each	37" x 22"
M76315	Each	49" x 22"

Cutting Board :

- Made of high density polyethylene approved for restaurants and butcher shops
- Material FDA approved, USDA approved, NSF certified
- Won't breed harmful bacteria
- Dishwasher safe
- 18" x 14" white

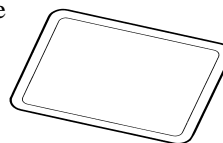

Item # M90251
U/M - Each

Cutting Board :

- Built in tempered glass food preparation center
- Heat resistant for hot cookware
- Impact resistant
- Includes frame and all mounting hardware
- Recessed mount

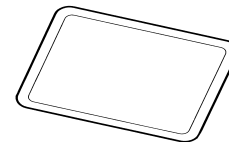

Item # M90256
U/M - Each

End Splash :

- Made of fine cultured marble
- White on white color
- Available in left or right handed
- 22" Length



Item #	U/M	Type
M76402	Each	Left Hand
M76404	Each	Right Hand

Vanity Base :

- Pre-assembled
- Flat panel door (pictured)
- Frameless construction
- All metal concealed hinges
- Oak vanities have a raised panel

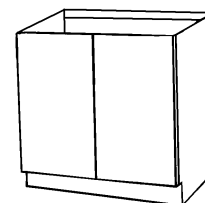
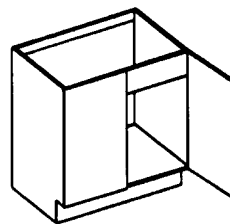

Item #	U/M	Finish	Size
M76007	Each	White	24" x 21"
M76013	Each	White	30" x 21"
M76019	Each	White	36" x 21"
M76025	Each	White	48" x 21"
M76048	Each	Oak	24" x 21"
M76052	Each	Oak	30" x 21"
M76057	Each	Oak	36" x 21"



MILL SUPPLY CO., INC.

Phone (410) 485-3343
Fax (410) 325-2240

Toll Free 1-800-817-8183

Plumbing

ECONOMY FAUCETS

Single Handle Kitchen Faucet :

- Metal body / Metal handle
- 8" center
- Heavy Chrome plating
- 1/2" IPS connections

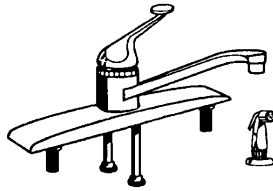

Item #	U/M	Description
M90282	Each	Less Spray
M90285	Each	With Spray

Two Handle Kitchen Faucet :

- Acrylic handles
- 8" center
- Heavy Chrome plating / Metal body
- 1/2" IPS connections

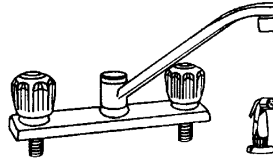

Item #	U/M	Description
M90288	Each	Less Spray
M90290	Each	With Spray

Single Handle Lavatory Faucet :

- Acrylic handle / 4" center
- Heavy Chrome plating / Metal body
- 1/2" IPS connections
- Less pop-up

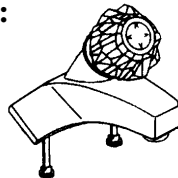

Item # M90292
U/M - Each

Single Handle Lavatory Faucet :

- Acrylic handle / 4" center
- Heavy Chrome plating / Metal body
- 1/2" IPS connections
- With metal pop-up

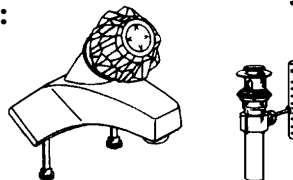

Item # M90294
U/M - Each

Two Handle Lavatory Faucet :

- Acrylic handles / 4" center
- Heavy chrome plating / Metal body
- 1/2" IPS connections
- Less pop-up

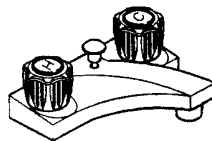

Item # M90304
U/M - Each

Two Handle Lavatory Faucet :

- Acrylic handles / 4" center
- Heavy chrome plating / Metal body
- 1/2" IPS connections
- With metal pop-up

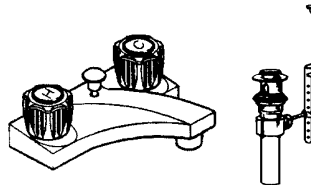

Item # M90298
U/M - Each

Single Handle Lavatory Faucet :

- Metal handle / 4" center
- Heavy chrome plating / Metal body
- 1/2" IPS connections
- With metal pop-up

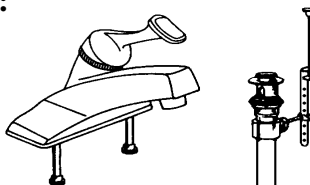

Item # M90301
U/M - Each



Plumbing

FAUCETS

8" Single Handle Kitchen Faucet :



- 3 Hole installation
- 8" Center
- 8" Long spout swings 360°
- Lever handle
- Chrome
- Mfg #100

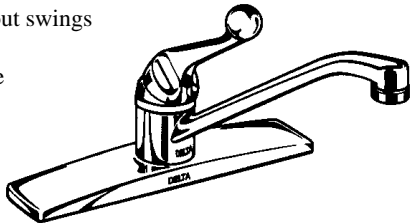

Item # M90353
U/M - Each

Twin Handle Kitchen Faucet :



- 3 Hole installation
- 8" Center
- 8" Long spout swings 360 degrees
- Acrylic handles
- Red & blue handle indicators
- 1/2" I.P.S. shanks
- Chrome
- Mfg #2102

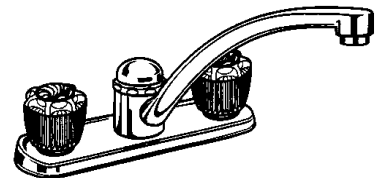

Item # M90365
U/M - Each

Single Handle Lavatory Faucet :



- 3 Hole installation
- 4" Centerset
- Acrylic handle
- Chrome
- Metal pop-up
- Mfg #522MPU

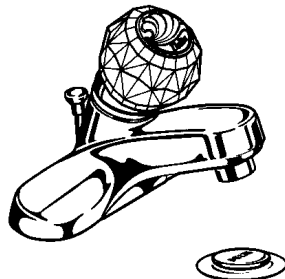

Item # M90383
U/M - Each

Twin Handle Lavatory Faucet :



- 3 Hole installation
- 4" Centerset
- Acrylic handles
- Red & Blue handle indicators
- Chrome
- Metal pop-up
- Mfg #252MPU

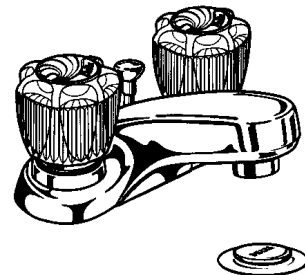

Item # M90368
U/M - Each

Twin Handle Lavatory Faucets :



- 2 & 3 Hole installation
- 4" Centerset
- Blade handles
- Chrome
- Metal pop-up
- Mfg #2520MPU

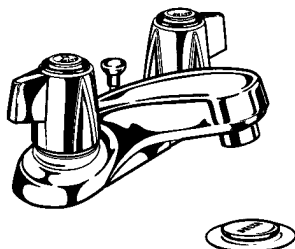

Item # M90371
U/M - Each

Single Handle Lavatory Faucet :



- 3 Hole installation
- 4" Centerset
- Lever handle
- Chrome
- Metal pop-up
- Mfg #520MPU

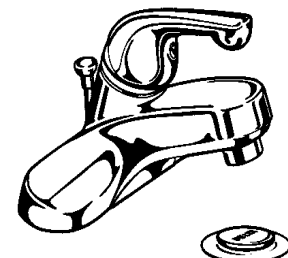

Item # M90380
U/M - Each



MILL SUPPLY CO., INC.

Phone (410) 485-3343
Fax (410) 325-2240

Toll Free 1-800-817-8183

Plumbing

PLUMBING

Single Lever Kitchen Faucet :

- 8" center
- 1/2" IPS connection
- Water/energy saving aerator
- Hook-up supplies included

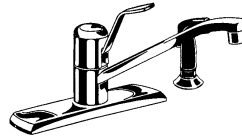

Item #	U/M	Description	Mfg #
M90415	Each	w/spray	87130
M90412	Each	less spray	87125

Single Lever Lavatory Faucet :

- 4" Center, 1/2' IPS, washerless
- Limited lifetime warranty
- Water/energy saving aerator
- Hook-up supplies included

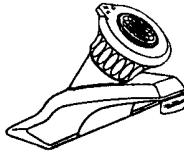

Item #	U/M	Description	Mfg #
M90409	Each	w/pop-up	84521
M90406	Each	less pop-up	84501

Two Handle Kitchen Faucet :

- Chrome plated 8" brass spout
- 1/2" Male shanks coupling nuts, renewable seats
- Brass compression valves

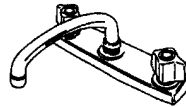

Item #	U/M	Description	Mfg #
M90533	Each	w/spray	26130PQ
M90530	Each	less spray	26110PQ

Two Handle Lavatory Faucet :

- Housing type
- 4" Centerset. 1/2" male shanks
- Brass compression water ways

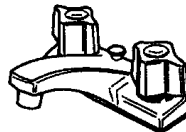

Item #	U/M	Description	Mfg #
M90518	Each	w/ pop-up	20170PQ
M90515	Each	less pop-up	20114PQ

Two Handle Tub/Shower Faucet :

- 8" center, 1/2" IP union, sliding escutcheon
- Includes diverter spout, shower head, arm and flange
- Mfg #11221PQ

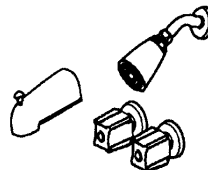

Item # M90509
U/M - Each

Three Handle Tub/Shower Faucet :

- 8" centers, sliding escutcheon
- Includes spout, shower head, arm and flange
- 1/2" IP union
- Mfg #10221PQ

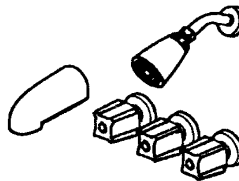

Item # M90506
U/M - Each

Single Handle Tub/Shower Faucet :

- Tub diverter spout, showerhead, arm and flange
- Washerless, lifetime limited warranty
- 1/2" IPS inlets
- Mfg #82519

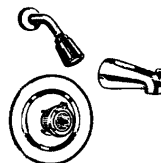

Item # M90403
U/M - Each



Plumbing

SPECIALTY FAUCETS & POP-UPS

Laundry Tray Faucet :

STERLING

- 4" Ledge type
- 1/2" I.P.S. shanks
- Chrome plated finish
- Solid brass body
- 6" Spout
- Blade handle
- Mfg #31210

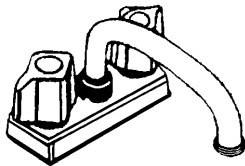

Item # M90536
U/M - Each

Laundry Tray Faucet :

STERLING

- 4" Ledge type
- 1/2" I.P.S. shanks
- Chrome plated finish
- ABS body
- 6" Spout
- Round acrylic handles
- Mfg #83770

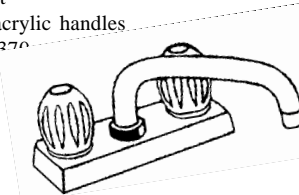

Item # M90503
U/M - Each

Laundry Tray Faucet :

STERLING

- 4" Centers
- 1/2" I.P.S. unions
- Rough brass
- 6" Spout
- Lever handles
- Tub or wall mount
- Mfg #31341

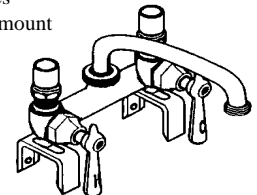

Item # M90539
U/M - Each

Sillcock :

- Heavy brass construction
- Notched flange for stable installation
- 3/4" Hose thread outlet



Item #	U/M	IP Size
M99720	Each	1/2"
M99721	Each	3/4"

Temperature & Pressure Relief Valve :

- Replacement for
*Watts Regulator Model
100XL-4
*Cash Acme Model
NCLX-5
- 150psi / 210 degree F.
- 3/4" Male inlet / 3/4" Female
outlet



Item # M99756
U/M - Each

Boiler Drain :

- Heavy brass construction
- Heavy cast iron handle
- 3/4" Hose thread outlet
- Male inlet

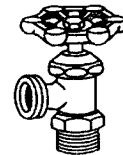

Item #	U/M	Inlet Size
M99906	Each	1/2"
M99907	Each	3/4"

Pop-Up Drain Assemblies :

- Lift rod, plunger and linkage
included



Item #	U/M	Description
M91296	Each	Non-metallic
M91294	Each	Chrome plated brass

Pop-up Drain Assembly :

STERLING

- 1-1/4" Drain, cast brass tee,
lift rod and knob
- Removable stopper
- Chrome plated
- Mfg #21170

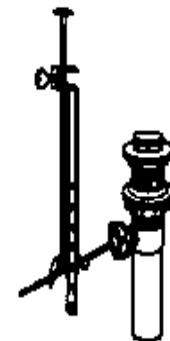

Item # M90527
U/M - Each



MILL SUPPLY CO., INC.

Phone (410) 485-3343
Fax (410) 325-2240

Toll Free 1-800-817-8183

Plumbing

POP-UP STOPPERS

Fits Most :

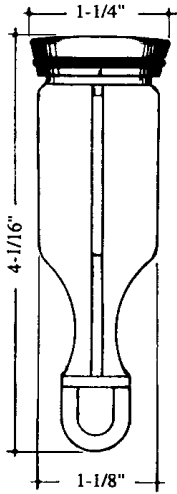

Item # M91300
U/M - Each

Fits American
Standard :

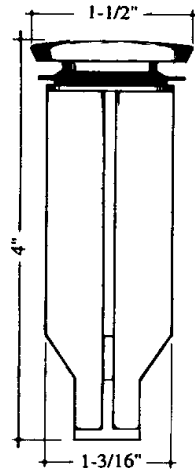

Item # M91301
U/M - Each

Fits Kohler :

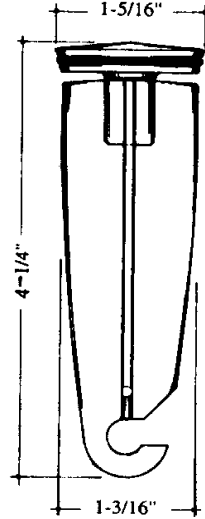

Item # M91303
U/M - Each

Fits Kohler :

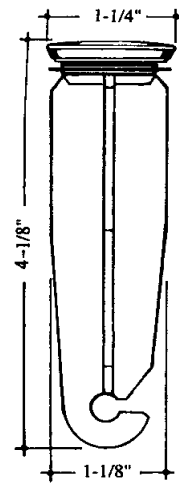

Item # M91304
U/M - Each

Fits Delta :

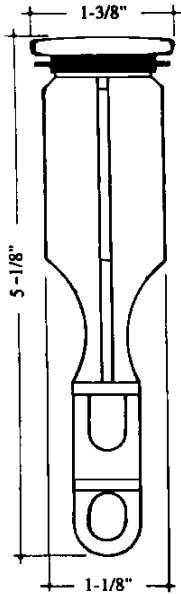

Item # M91305
U/M - Each

Fits Moen :

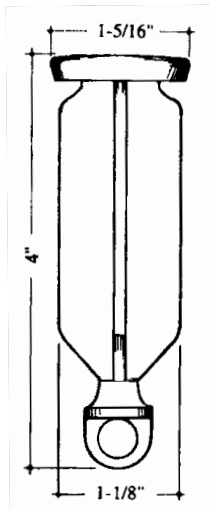

Item # M91309
U/M - Each

Fits Price
Pfister :

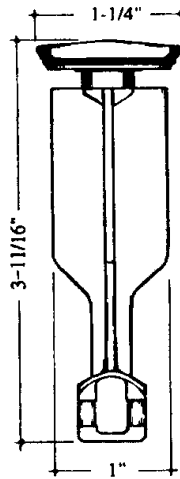

Item # M91311
U/M - Each

Fits Sterling :

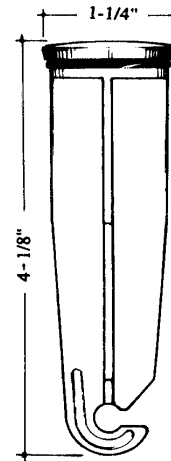

Item # M91307
U/M - Each

Universal
"Flip-It"
Fits all :

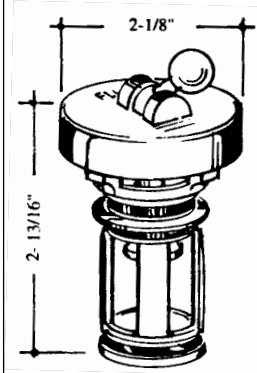

Item # M91210
U/M - Each

The illustrations on this page are the property of Kissler & Company Inc. A registered copyright has been filed with the Library of Congress (Copyright Office) Division of The United States Government. No attempt to copy any of these illustrations should be made without the express written permission of Kissler & CO.



Plumbing

REPAIR PARTS FOR DELTA *

Lavatory Handle :

- Acrylic
- Includes button and screw
- Fits all lav. that use 212 type ball

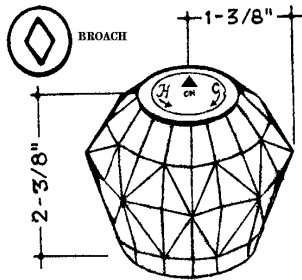

Item # M90680
U/M - Each

Replacement Handle :

- Acrylic canopy
- Includes buttons and screws
- Replaces lav., kitchen or tub handles
- Replaces #RP5693
- Sold by the pair only

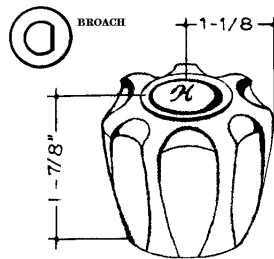

Item # M90683
U/M - Pair

Replacement Stem :

- Plastic
- Fits Delta and many imported faucets
- Replaces #RP1740

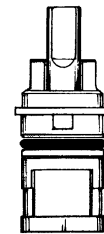

Item # M90656
U/M - Each

Brass Ball :

- For metal handles
- Replaces #RP70

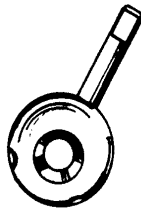

Item # M90659
U/M - Each

Seats & Springs :

- Contains 2 complete sets of both old and new style springs and TPR seats
- Replaces #RP134 & #RP4993

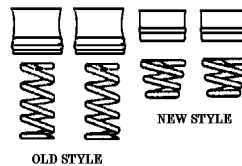

Item # M90665
U/M - Each

Diverter Assembly :

- For single handle kitchen deck faucets
- Replaces #RP320



Item # M90671
U/M - Each

Repair Kit #1 :

- For Delta type faucets with swing type spout
- Includes old and new style TPR seats and springs, teflon lined cam, spout O-rings, and faucet wrenches
- Sold as a complete set

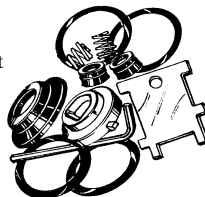

Item # M90674
U/M - Each

Repair Kit #2 :

- For Delta type crystal handle lav., tub and shower faucets
- Teflon lined cam assembly, 2 new style springs and seats, and faucet wrenches
- Sold as a complete set

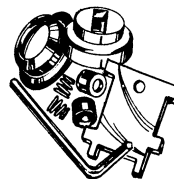

Item # M90668
U/M - Each

8" Swing Spout :

- For single handle type faucets
- 8" Swing spout
- Chrome plated
- Replaces #RP5654

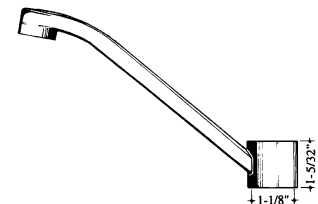

Item # M90685
U/M - Each

* Brand names, model names, original manufacturers' name or stock numbers, which may appear on seller's invoices, catalogs, packages, quotations or correspondence, are so utilized for the purposes of identification only; and are not a warranty or representation, either express or implied, that items offered or sold are genuine products of such original manufacturers.



MILL SUPPLY CO., INC.

Phone (410) 485-3343
Fax (410) 325-2240

Toll Free 1-800-817-8183

Page 283

Plumbing

REPAIR PARTS FOR MOEN *



Genuine Moen Cartridges :

- Repairs most leaks and restores faucet action to like new condition
- Made in U.S.A.

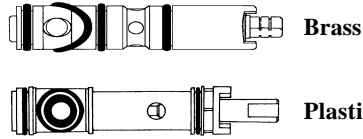

Item #	U/M	Description	Mfg #
M90802	Each	Brass body	1200
M90812	Each	Plastic Body	1225

Replacement Cartridges for Moen :

- A low cost alternative to genuine cartridges
- Imported

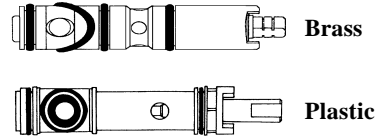

Item #	U/M	Description
M90801	Each	Brass Body
M90811	Each	Plastic Body

Repair Kit #1 :

- For Moen plastic type cartridges
- Includes; 2 side seals, 10 spout & cartridges O-rings, 3 clips, installation tool and lubricant capsule

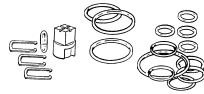

Item # M90830
U/M - Each

Repair Kit #2 :

- For Moen brass type cartridges
- Includes; cap & spout seals, 10 spout & cartridges O-rings, 3 clips, installation tool and lubricant capsule

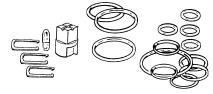

Item # M90639
U/M - Each

Teardrop Lavatory Handle :

- Short broach
- Includes button & screw
- Replaces #96791

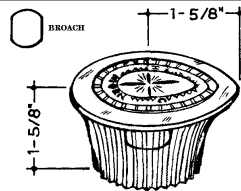

Item # M90815
U/M - Each

Teardrop Tub Handle :

- Long broach
- Includes button & screw
- Replaces #96797

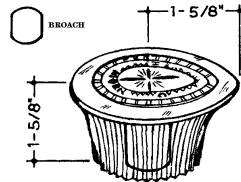

Item # M90822
U/M - Each

Round Lavatory Handle :

- Short broach
- Includes button & screw
- Replaces #13092

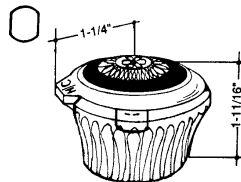

Item # M90817
U/M - Each

Round Tub Handle :

- Long broach
- Includes button & screw
- Replaces #13094

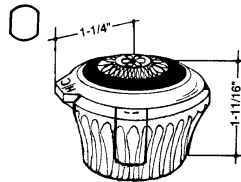

Item # M90810
U/M - Each

* Brand names, model names, original manufactures' name or stock numbers, which may appear on seller's invoices, catalogs, packages, quotations or correspondence, are so utilized for the purposes of identification only; and are not a warranty or representation, either express or implied, that items offered or sold are genuine products of such original manufacturers.



MILL SUPPLY CO., INC.

Phone (410) 485-3343
Fax (410) 325-2240

Toll Free 1-800-817-8183

Plumbing

REPAIR PARTS FOR MOEN *

Handle Assembly Kit :

- Genuine Moen replacement part
- For Chateau single handle kitchen deck faucets
- Handle not included
- Mfg #14991

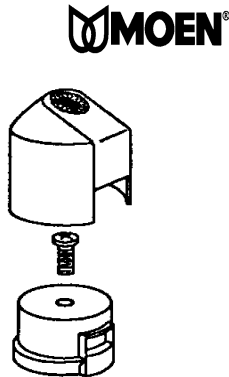

Item # M90805
U/M - Each

Lever Handle :

- Genuine Moen replacement part
- For Chateau single handle kitchen deck faucets
- Mfg #14492

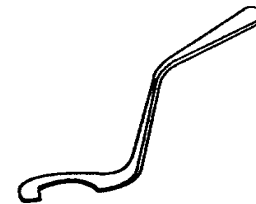

Item # M90819
U/M - Each

Cap & Emblem Assembly :

- Genuine Moen replacement part
- For Chateau single handle kitchen deck faucets
- Mfg #14483

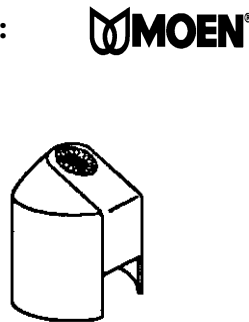

Item # M90816
U/M - Each

Cap & Cover Assembly :

- Includes cap, cover and screw
- For Chateau series
- Replaces #96790

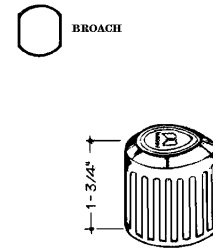

Item # M90806
U/M - Each

Cap & Handle Assembly New Style :

- Fits "New Style" Moen Chateau series faucets
- Replaces #96790 & 10927

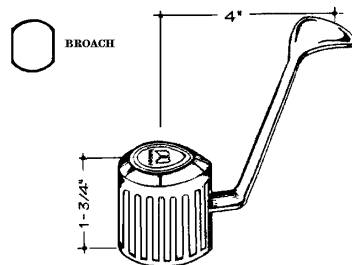

Item # M90807
U/M - Each

Cap & Handle Assembly Old Style :

- Fits "Old Style" Moen Chateau series faucets

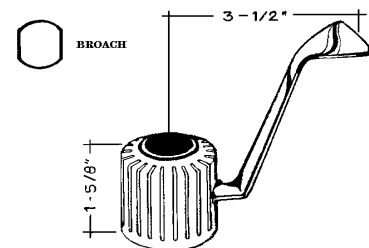

Item # M90804
U/M - Each

* Brand names, model names, original manufactures' name or stock numbers, which may appear on seller's invoices, catalogs, packages, quotations or correspondence, are so utilized for the purposes of identification only; and are not a warranty or representation, either express or implied, that items offered or sold are genuine products of such original manufacturers.



MILL SUPPLY CO., INC.

Phone (410) 485-3343
Fax (410) 325-2240

Toll Free 1-800-817-8183

Plumbing

STEMS

STEMS ARE SOLD WITH BONNETS BY THE EACH
STEMS ARE ACTUAL SIZE

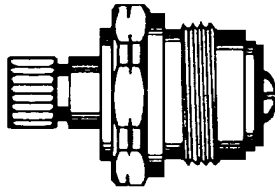
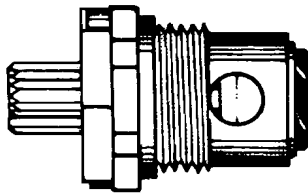
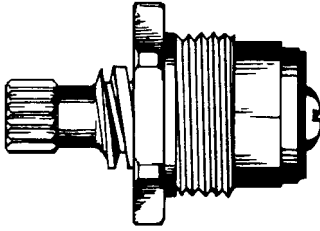
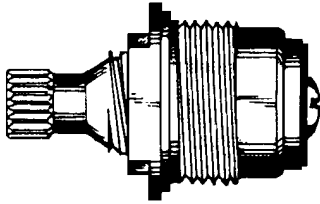
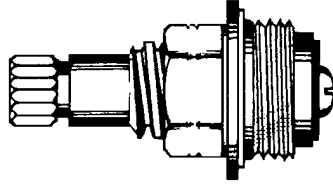

Replacement Stem for:	Union Brass	Gerber - Old Style	Gerber - New Style	Price Pfister
Item # M91033 LH- Hot	Item # M91036 RH- Hot	Item # M91003 RH- Hot	Item # M91005 RH- Hot	Item # M91011
Item # M91034 RH- Cold	Item # M91037 LH- Cold	Item # M91002 LH- Cold	Item # M91004 LH- Cold	RH- Hot/Cold
Replacement Seat				
Item # M91035 1/2-27T	N/A	Item # M91006 5/8 - 20T	Item # M91006 5/8 - 20T	Item # M91012 1/2 - 20T
Replacement Washer				
Item # M90583 "00" Flat	N/A	Item # M90589 1/4 Flat	Item # M90589 1/4 Flat	Item # M90583 "00" Flat

The illustrations on this page are the property of Kissler & Company Inc. A registered copyright has been filed with the Library of Congress (Copyright Office) Division of The United States Government. No attempt to copy any of these illustrations should be made without the express written permission of Kissler & CO.



Plumbing

STEMS

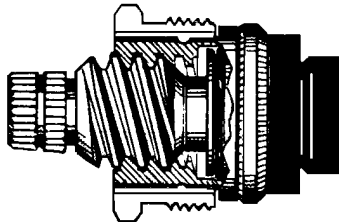
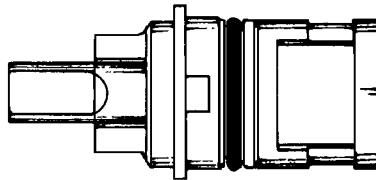
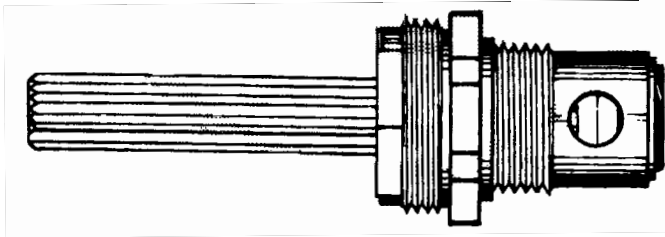
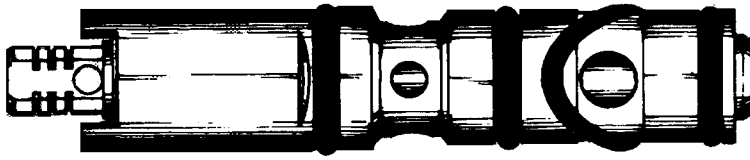
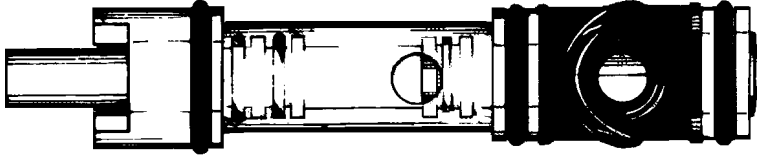

American Standard	Delta	Union Brass	Moen	Moen
Item # M91007 RH- Hot	Item # M90656	Item # M91010	Item # M90802	Item # M90812
Item # M91008 LH - Cold	RH- Hot/Cold	RH- Hot/Cold	Generic	Generic
Replacement Seat				
Item # M91009 7/16-24T	Item # M90665	N/A	N/A	N/A
Replacement Washer				
Item # M91043 Aqua Seal	N/A	N/A	N/A	N/A

The illustrations on this page are the property of Kissler & Company Inc. A registered copyright has been filed with the Library of Congress (Copyright Office) Division of The United States Government. No attempt to copy any of these illustrations should be made without the express written permission of Kissler & CO.



MILL SUPPLY CO., INC.

Phone (410) 485-3343
Fax (410) 325-2240

Toll Free 1-800-817-8183

Plumbing

STEMS

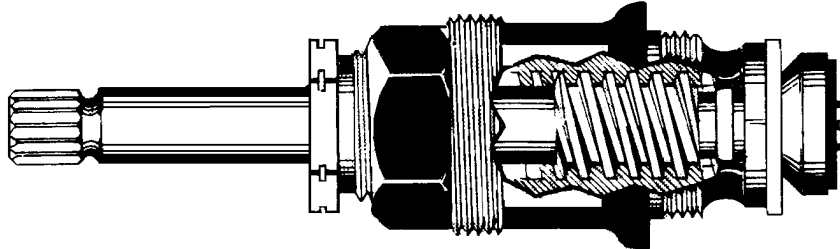
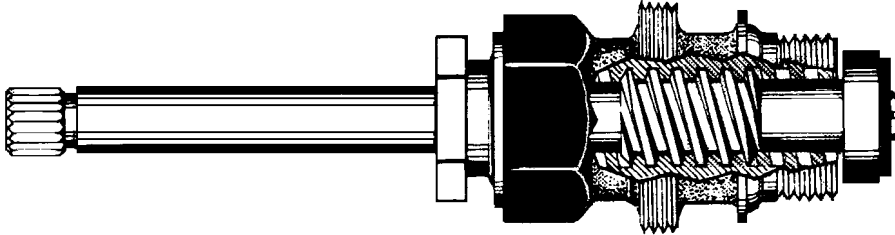
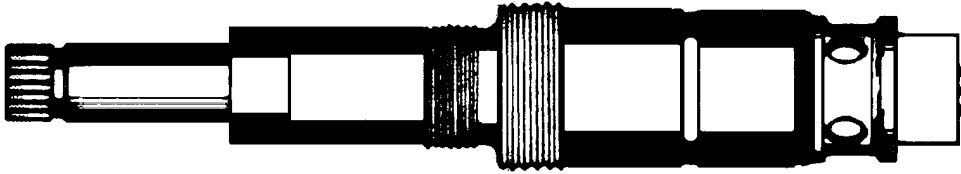

Price Pfister	American Standard	Sterling	Sterling	American Standard
Item # M91023 RH - Diverter	Item # M91041 RH - Hot/Cold	Item # M91019 RH - Hot/Cold	Item # M91021 RH - Diverter	Item # M91040 RH - Diverter
Replacement Seat	Item # M91042	Item # M91020	Item # M91020	Item # M91042
Item # M91024	1/2 - 20T	1/2 - 24T	1/2 - 24T	1/2 - 20T
Replacement Washer	Item # M90586	Item # M90592	Item # M90592	Item # M91014
Item # M90601	"0" Flat	1/4L Flat	1/4L Flat	
	3/8L Flat			

The illustrations on this page are the property of Kissler & Company Inc. A registered copyright has been filed with the Library of Congress (Copyright Office) Division of The United States Government. No attempt to copy any of these illustrations should be made without the express written permission of Kissler & CO.



Plumbing

STEMS

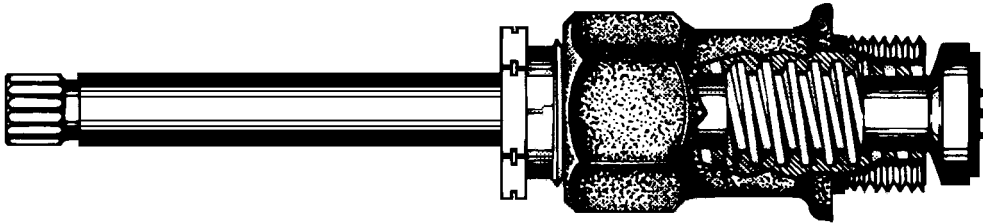
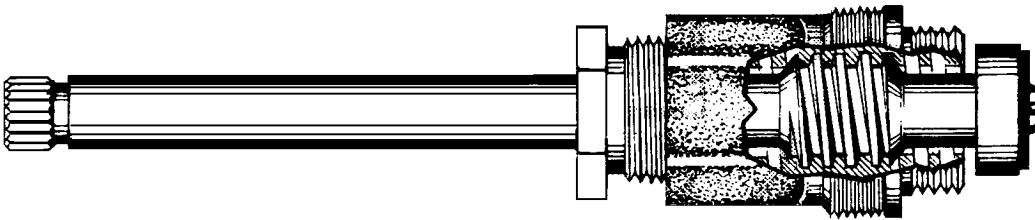
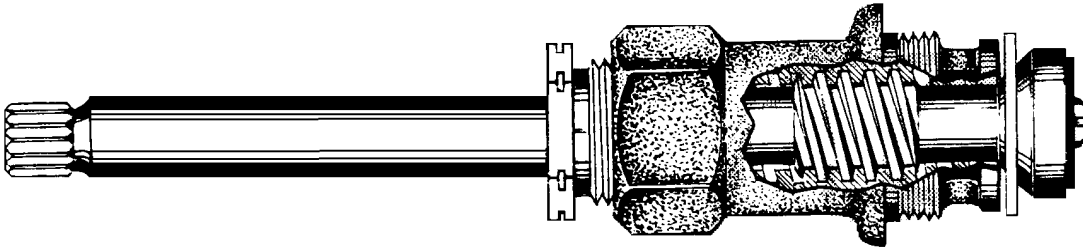
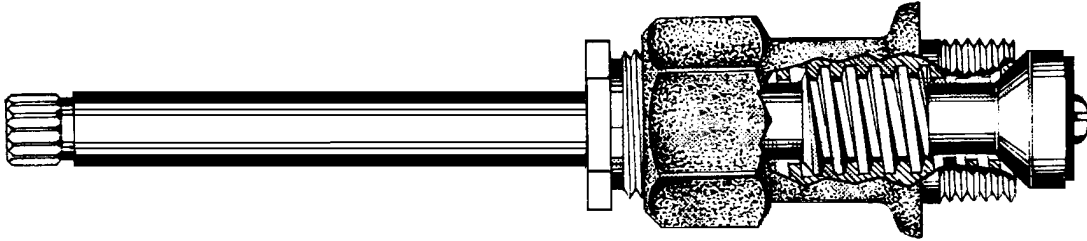
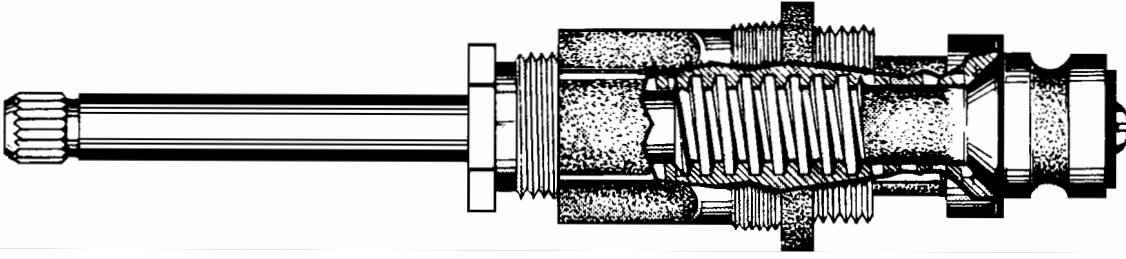

Price Pfister	Gerber	Price Pfister	Gerber
Item # M91031 RH - Diverter	Item # M91017 RH - Hot/Cold	Item # M91027 RH - Hot/Cold	Item # M91029 RH - Diverter
Replacement Seat			
Item # M91024 21/32 - 18T	Item # M91006 5/8 - 20T	Item # M91024 21/32 - 18T	Item # M91006 5/8 - 20T
Replacement Washer			
Item # M90592 1/4L Flat	Item # M90592 1/4L Flat	Item # M90601 3/8L Flat	Item # M90592 1/4L Flat

The illustrations on this page are the property of Kissler & Company Inc. A registered copyright has been filed with the Library of Congress (Copyright Office) Division of The United States Government. No attempt to copy any of these illustrations should be made without the express written permission of Kissler & CO.



MILL SUPPLY CO., INC.

Phone (410) 485-3343
Fax (410) 325-2240

Toll Free 1-800-817-8183

Plumbing

Plumbing

FAUCET REPAIR PARTS

Symmons Body Unit :

- Genuine Symmons repair part
- Actual size

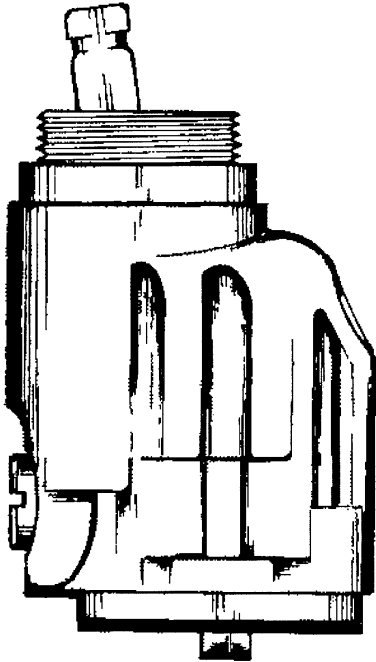

Item #	U/M	Description	Mfg #
M91045	Each	Lavatory	L-4A
M91046	Each	Kitchen	K-4A

Faucet O-Ring Kit :

- Contains 200 assorted O-Rings
- 12 most common sizes used in the plumbing industry

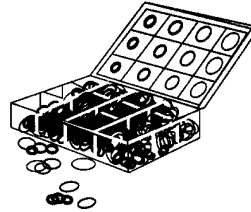

Item # M90648
U/M - Each

Bibb Washer & Screw Assortment :

- 48 piece set
- Contains "00"-3/8 flat & beveled washers and 3 screws

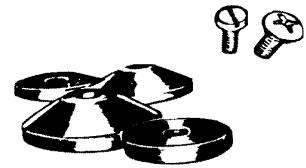

Item # M90553
U/M - Each

American Standard Washer :

- Fits Aqua Seal
- Replaces # 72960-07

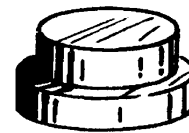

Item # M91043
U/M - Each

Bibb Washers :

- Actual size
- Sold in packs of 100 only

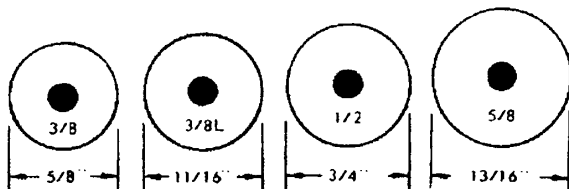
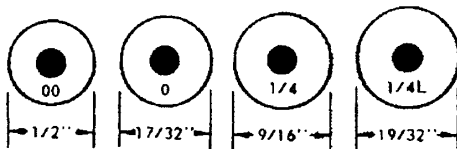

Trade Size	U/M	Flat	Beveled
"00"	Pack	M90583	M90578
"0"	Pack	M90586	M90562
1/4	Pack	M90589	M90565
1/4L	Pack	M90592	M90568
3/8	Pack	M90595	M90571
3/8L	Pack	M90601	M90559
1/2	Pack	M90604	M90558
5/8	Pack	M90607	M90561
Assorted	Pack	M90577	M90556



FLAT



BEVELED



MILL SUPPLY CO., INC.

Phone (410) 485-3343
Fax (410) 325-2240

Toll Free 1-800-817-8183

Plumbing

TOILET REPAIR PARTS

Spud Washers :

- Flanged
- Rubber

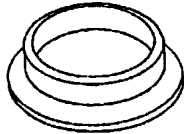

Item #	U/M	Size
M92339	Each	1-1/2"
M92343	Each	2"

Brass Closet Spuds :

- Rough brass

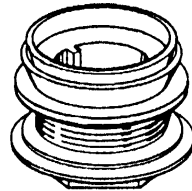

Item #	U/M	Size
M92347	Each	1-1/2"
M92351	Each	2"

Tank-To-Bowl Gaskets :

- Sponge rubber



Item #	U/M	Description
M92168	Each	Std. 3-1/4" OD
M92188	Each	For Eljer
M92186	Each	For Gerber
M92173	Each	For American Std.
M92183	Each	For Crane

Closet Bowl Wax Rings :

- Fit-All
- Plastic sleeve fits 3" x 4" waste line
- For floor type closet bowls

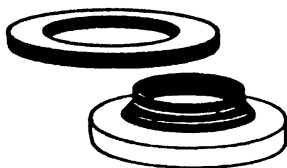

Item #	U/M	Description
M92159	Each	less flange
M92151	Each	with flange

Heavy Duty Closet Bowl Wax Ring :

- 40% more wax than other gaskets
- Save labor time on installations and makes for positive seal



Item # M92154
U/M - Each

Spanner Flange :

- Eliminates the need to replace broken cast iron or plastic ring
- Suitable for use with cast iron, plastic, copper and brass closet flange



Item # M92228
U/M - Each

Close Coupled Bolt Combinations :

- Brass plated
- 5/16" x 3"
- For attaching tank to bowl
- Includes; 2 bolts, hex nuts, wing nuts, 4 rubber washers and 4 steel washers

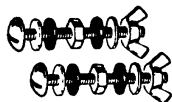

Item # M92204
U/M - Each

Closet Bolt :

- Brass plated steel
- 5/16" x 2-1/4"
- For attaching bowl to floor
- Includes; 2 bolts, nuts, washers and speed nuts

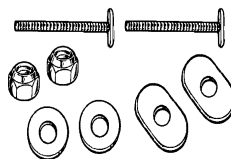

Item # M92201
U/M - Each

Plastic Bolt Caps :

- Push on type
- Covers exposed toilet bolts

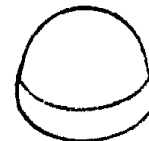

Item # M92076
U/M - Each



MILL SUPPLY CO., INC.

Phone (410) 485-3343
Fax (410) 325-2240

Toll Free 1-800-817-8183

Page 291

Plumbing

TOILET REPAIR PARTS

400A Ballcock :

- Stops leaks and squeaks
- Fits most toilet tanks
- Saves water
- Easy to install
- Adjustable height 9"-14"
- Anti-siphon operation

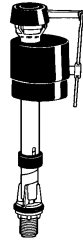

Fluidmaster

Item # M92045

U/M - Each

Refill Tube Assembly :

- Genuine Fluidmaster repair part
- Mfg# 218

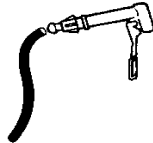

Fluidmaster

Item # M92039

U/M - Each

Replacement Seal :

- Genuine Fluidmaster repair part
- Mfg# B212



Fluidmaster

Item # M92036

U/M - Each

Ballcock Repair Kit :

- Genuine Fluidmaster repair part
- Kit includes flipper seal, refill tube, supply nut, and two seals
- Mfg# B220

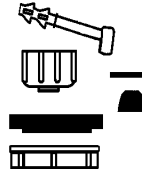

Fluidmaster

Item # M92042

U/M - Each

American Standard Flush Valve :

- Replaces #3158.078
- Old #5

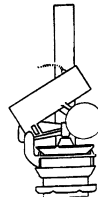

Item # M92249

U/M - Each

American Standard Float Assembly :

- Replaces #73380-07
- Old #5 & 6

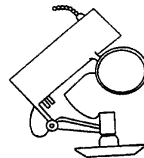

Item # M92253

U/M - Each

American Standard Float Assembly :

- Replaces #33642-07
- #5

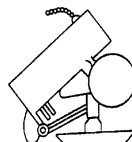

Item # M92256

U/M - Each



Plumbing

TOILET REPAIR PARTS

Seat Disc :

- Fits all American Standard flush valves
- Easy to install

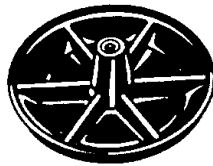

Item #	U/M	Description
M92238	Each	Screw-On
M92240	Each	Snap-On

Douglas Type Flush Valve :

- Easy to install
- Always shuts without hanging up

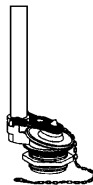

Item # M92261
U/M - Each

1B1 Ballcock Repair Kit :

- Kit includes complete piston, 1-1/4 & 1-1/2 diaphragm, rubber piston washer, seat washer, cap gasket, and screws



Item # M92021
U/M - Each

Eljer Touch Flush Assembly :

- Chrome plated handle
- Rubber float

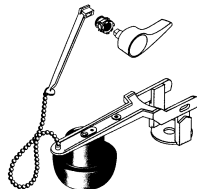

Item # M92276
U/M - Each

Eljer Tank Ball :

- Designed to fit the curvature of all flush valves
- Built-in flexibility insures perfect sealing



Item # M92286
U/M - Each

Toilet Tank Float Ball :

- Leakproof plastic
- 4" x 5"



Item # M92319
U/M - Each

Ballcock Float Rod :

- 8" Brass



Item # M92303
U/M - Each

Tank Ball Lift Wire :

- Fits all tank balls on the market
- Brass



Item #	U/M	Description
M92311	Each	4-1/2" Lower
M92309	Each	9" Upper



MILL SUPPLY CO., INC.

Phone (410) 485-3343
Fax (410) 325-2240

Toll Free 1-800-817-8183

Plumbing

TOILET REPAIR PARTS

Fit-All Tank Ball Guide :

- Adjustable, fits all tubes
- Entire guide tightens to overflow tube with just one screw
- Leverage type
- Brass

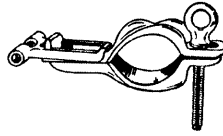

Item # M92324

U/M - Each

Flush Valve Shank Washer :

- Beveled rubber
- 2-1/4" ID x 3-1/8" OD x 3/8" thick



Item # M92334

U/M - Each

Ballcock Shank Washer :

- Rubber
- 7/8" ID x 1-11/16" x 1/2" thick

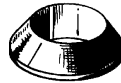

Item # M90611

U/M - Each

Ballcock Lock Nut :

- 7/8" ballcock thread



Item #	U/M	Description
M92269	Each	Brass
M92270	Each	Plastic

Ballcock Coupling Nut :

- 7/8" ballcock thread

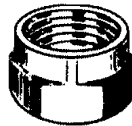

Item # M92268

U/M - Each

Beaded Chain Upper Wire :

- N.P. Brass
- With hook and attach to tank lever or lower wire



Item # M92296

U/M - Each

Flapper Lift Chain :

- 9" Stainless steel
- With hook & bullnose

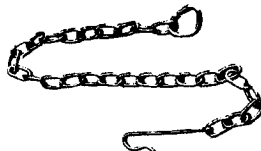

Item # M92299

U/M - Each



Plumbing

TOILET REPAIR PARTS

Big Ben Flapper :

- Improved design insures positive seal
- Warranted 5 years

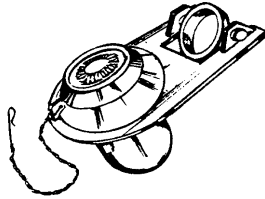

Item # M92025
U/M - Each

3-Way Flapper :

- Removable collar
- Fits Douglas flush valves
- Fits Crane without overflow tube
- Fits new style valves with posts

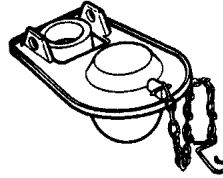

Item # M92029
U/M - Each

Coast Flapper :

- Genuine Coast replacement part
- Mfg# 400



Item # M92033
U/M - Each

Sealmaster Flapper :

- Positive sealing
- Easy flushing
- Quiet operation
- Mfg# B-264

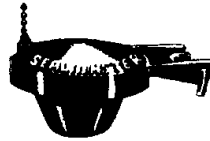

Item # M92027
U/M - Each

Seal-O-Matic Flapper :

- Stops leaking toilets
- Fits most conventional flush valves
- Eliminates guide arms
- Mfg# B-260



Item # M92032
U/M - Each

Anchor Flapper :

- Fits old & new style flush valves
- Easy to install
- Eliminates guide arms
- Mfg# B-257

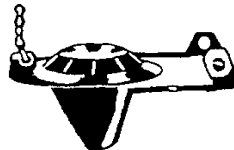

Item # M92026
U/M - Each

Flusher Fixer Kit :

- Stops noisy tank drain leaks
- Includes flapper and seat
- Easy to install, fits most tanks
- Floating chain eliminates outdated wires/guides



Fluidmaster

Item #	U/M	Description	Mfg#
M92052	Each	Complete Kit	555C
M92049	Each	Flapper Only	B500P10



MILL SUPPLY CO., INC.

Phone (410) 485-3343
Fax (410) 325-2240

Toll Free 1-800-817-8183

Page 295

Plumbing

TOILET REPAIR PARTS

Universal Tank Lever :

- Chrome finished metal handle
- Brass plated arm
- 8-1/2" length

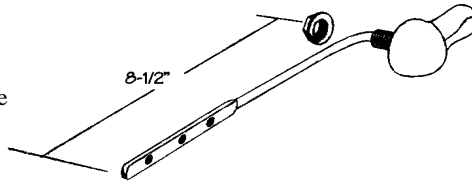

Item #	U/M	Description
M92103	Each	Plastic Nut
M92106	Each	Brass Nut

Short Arm Tank Lever :

- 4-1/4" length
- Fits Eljer, Briggs and American Standard
- Plastic handle & nut, chrome finished handle

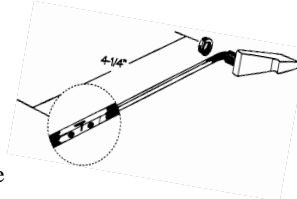

Item # M92100
U/M - Each

Side Mount Tank Lever :

- 9-1/4" length
- Fits Eljer
- Plastic nut, brass arm, chrome finished metal handle

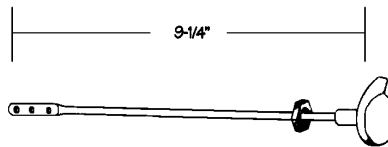

Item # M92091
U/M - Each

Universal Tank Lever :

- 8-1/2" length
- Plastic handle, nut and arm
- Chrome finished handle

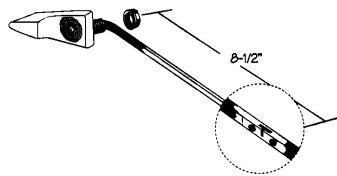

Item # M92109
U/M - Each

Tank Lever for Mansfield :

- 10-1/4" length
- Brass bent arm
- Plastic nut, chrome finished metal handle

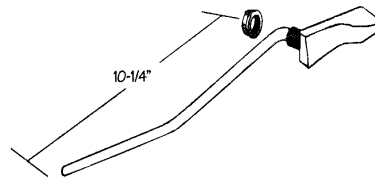

Item # M92094
U/M - Each

Tank Lever for Mansfield :

- 9-1/8" length
- Blue plastic, bendable arm
- Plastic nut, chrome finished plastic handle

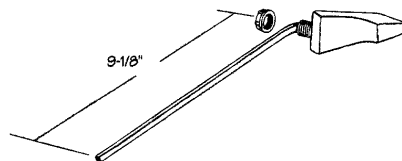

Item # M92097
U/M - Each

Polished Brass Tank Lever :

- 8-1/2" length
- Brass arm
- Metal handle, polished brass finish
- Metal nut

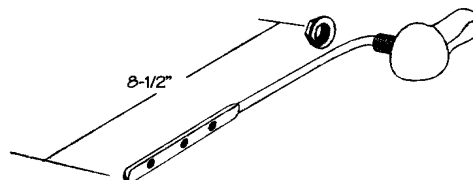

Item # M92110
U/M - Each



Plumbing

TOILET REPAIR PARTS

Regular Closed

Front Toilet Seat :

- Classic molded wood with an extremely durable electrostatically applied baked enamel, high gloss finish
- Easy to install, color matched top mount hinges with corrosion free nylon hinge posts
- Large, snap on replaceable bumpers for stability
- Pressure sensitive adhesive gasket for secure installation
- Sold by the each

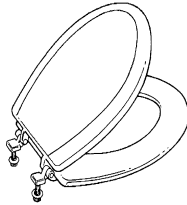

Item #	U/M	Color
M90024	Each	White
M90027	Each	Bone
M90057	Each	Dresden Blue
M90042	Each	Beige
M90036	Each	Pink
M90030	Each	Harvest Gold
M90054	Each	Yellow

Colors

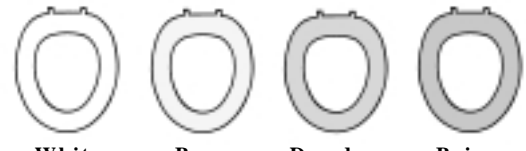

White

Bone

Dresden
Blue

Beige



Pink

Harvest
Gold

Yellow

Elongated Closed

Front Toilet Seat :

- Classic molded wood with an extremely durable electrostatically applied baked enamel, high gloss finish
- Easy to install, color matched top mount hinges with corrosion free nylon hinge posts
- Large, snap on replaceable bumpers for stability
- Pressure sensitive adhesive gasket for secure installation
- Sold by the each

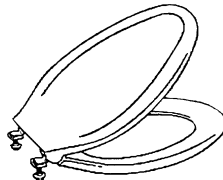

Item #	U/M	Color
M90003	Each	White
M90012	Each	Bone
M90009	Each	Har/Gold

White Elongated Open

Front Toilet Seat : (Less Cover)

- Classic molded wood with an extremely durable electrostatically applied baked enamel, high gloss finish
- Easy to install, color matched top mount hinges with corrosion free nylon hinge posts
- Large, snap on replaceable bumpers for stability
- Pressure sensitive adhesive gasket for secure installation
- Sold by the each

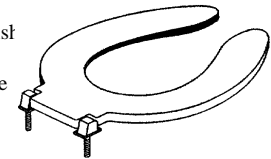

Toto Toilet :



- Round front gravity feed
- Two piece tank and bowl
- 1.6 GPF / 6.0 LPF Tank
- Gravity feed flush
- 12" rough in, less supply
- Less seat
- Sold as a complete set only

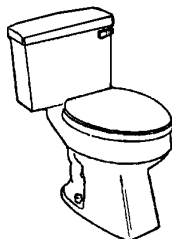

Item #	U/M	Color
M90166	Each	White
M90169	Each	Bone

Toilet Tank Cover :

- Replacement cover made of high impact plastic
- High tension spring adjusts cover to fit round or beveled corner tanks, wall hung or free standing
- Recess styling



Item # M92496
U/M - Each

Drain Plunger:

- 6" Cup
- For general household use
- Includes wood handle

Item # M92481
U/M - Each

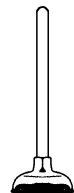

Free-Flow Plunger :

- 6" Cup
- For all types of sinks, bowls, and drains
- Includes wood handle

Item # M92487
U/M - Each

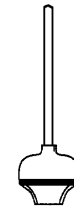

Heavy Duty Plunger :

- Heavy Duty 6" Cup
- Provides high capacity force against tough toilet and drain stoppages
- Includes wood handle

Item # M92484
U/M - Each

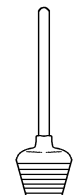

MILL SUPPLY CO., INC.

Phone (410) 485-3343
Fax (410) 325-2240

Toll Free 1-800-817-8183

Plumbing

DRAIN CLEANING EQUIPMENT

RIDGID | Kollmann

K-3 Closet Auger :

- Fast and safe clearing of closet obstructions
- Durable, kink-resistant 1/2" compression wrapped inner core cable
- Large, ergonomically designed handle
- 3' length / Bulb head



Item # M22016
U/M - Each

K-26 Hand Spinner :

- Slip resistant collet chuck that clasps/unclasps cable with the flick of the wrist
- 5/16"x25' cable with bulb head auger for maximum flexibility
- Plastic drum won't rust or dent also permits access to cable to apply rust inhibitor



Item # M92002
U/M - Each

K-40GPF Drain Cleaning Machine:

Lightweight only 28lbs. w/25' x 5/16" Cable

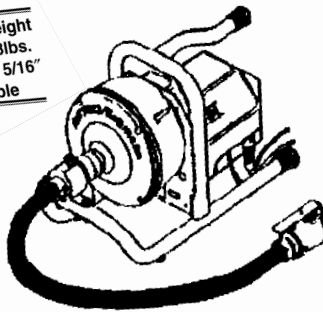

Model # K40-GPF
Includes:
-Autofeed
-Guide Hose
-Mounting Bracket

Item # M22082
U/M - Each

The K-40 Sink Machine is the latest newly designed labor saving drain cleaning machine from RIDGID/Kollmann. This UL/CSA patent pending machine is ideal for cleaning small secondary drain lines from 3/4" to 2". And when used with the back-saving Guide Tube Autofeed combination - **THERE IS NO MESS!** Your hands literally never need to touch the cable.

K-39-5 Drain Gun :

- Lightweight and easy to use
- Excellent for cleaning drains up to 2-1/2"
- Drums won't rust or dent - ever
- CSA approved
- Includes 25' of 5/16" cable, 35' of 3/8" cable, 2 drums, 5 piece tools set, and a metal carrying case

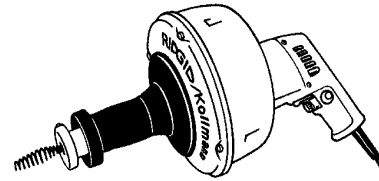

Item # M22081
U/M - Each

Chemical Drain Openers
Page 304

K-50 Drain Cleaning Machine :

For cleaning 3/4" through 4" lines through 100'
Handles 5/8" sectional cable through 100'
Quickly adapts to spin 25' of 5/16" cable or 35' of 3/8" cable
Here is a uniquely versatile machine for small to medium jobs. Easy to carry, it features famous RIDGID/Kollmann speed-cleaning through traps and bends at 400 rpm. Instant-acting clutch, with fingertip starting, stopping, reversing.
1/4 hp, 115V., 60-Hz. (available with 230V, 50 Hz motor) motor.
Available in four combinations which include various selections of cables, tools and accessories. A-30 Cable Kit Complete, adapts the K-50 to clean lines from 1-1/2" through 3". A-30 includes 45' (6 lengths) of 5/8" open wind cable with Speed Coupler in steel carrier, grease "C" cutter, bulb auger, straight auger, coupling pin key and 6' guide hose.

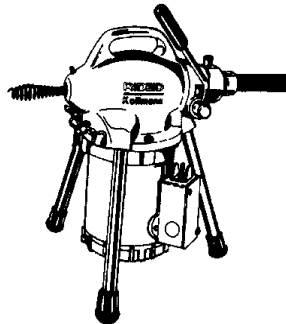

Item # M21972
Model # K-50 Machine Only

Item # M21976
Model # K-50-4 Machine with:
A-30 Cable kit

Item # M21978
Model # K-50-6 Machine with:
A-17-A Adapter
A-30 Cable kit

Item # M21980
Model # K-50-8 Machine with:
A-17-A & A-17-B Adapters
A-30 Cable kit



Plumbing

RIDGID ACCESSORIES

Straight Auger :

RIDGID

- Straight 5"
- For use in exploring and breaking up stoppages or returning sample to surface to determine correct tool
- Fits cables C-4, C-6 and C-8
- Mfg# T-201



Item # M22052
U/M - Each

Bulb Auger :

RIDGID

- 3" Long , 1-1/8" diameter
- Used for easy cleaning of lines with a number of elbows
- Fits cables C-4, C-6 and C-8
- Mfg# T-202



Item # M22056
U/M - Each

Drop Head Auger :

RIDGID

- 4" Long
- For cleaning back to back mounted fixtures e.g., sinks where cable needs to be led into down pipe
- Fits cables C-4, C-6 and C-8
- Mfg# T-217



Item # M22076
U/M - Each

Funnel Auger :

RIDGID

- 3" Long
- For use as second tool in line
- Breaks up remains of stoppage left by straight auger
- Fits cables C-4, C-6 and C-8
- Mfg# T-206



Item # M22064
U/M - Each

Grease "C" Cutter :

RIDGID

- 1-3/8"
- For grease blockage in lines leading from garbage disposal unit or waste pipe
- Fits cables C-4, C-6 and C-8
- Mfg# T-205



Item # M22060
U/M - Each

Spiral Bar Cutter :

RIDGID

- 1-1/4"
- For main sewers blocked by roots, leaf debris, sticks, sawdust, cloth, sacking
- Fits cables C-4, C-6 and C-8
- Mfg# T-207



Item # M22068
U/M - Each

Spade Cutter :

RIDGID

- 1" Wide
- For following up after augers have been used and to open up floor drains
- Fits cables C-4, C-6 and C-8
- Mfg# T-210



Item # M22072
U/M - Each

Four Blade Saw Tooth Cutter :

RIDGID

- 1-3/8" Wide
- For blockages caused by hardened, glazed material such as chemical deposits
- Fits cables C-4, C-6 and C-8
- Mfg# T-214



Item # M22074
U/M - Each

Operator Mitt :

RIDGID

- Tough leather, heavily riveted for maximum strength against rotating cable



Item #	U/M	Description	Mfg#
M22004	Each	Right hand	A-2
M21984	Each	Left Hand	A-1

Pin Key :

RIDGID

- For 5/8" cable
- Mfg# A-13



Item # M21992
U/M - Each



MILL SUPPLY CO., INC.

Phone (410) 485-3343
Fax (410) 325-2240

Toll Free 1-800-817-8183

Plumbing

RIDGID ACCESSORIES

C-1 Cable w/Bulb Auger :

RIDGID

- 5/16" x 25', with bulb auger
- For drain lines 3/4" to 1-1/2"
- Ideal for kitchen sinks, lavatory sinks, bathtub drains, drinking fountains, and urinals
- For K-40, K-39-5 and K-50 machines



Item # M22020
U/M-Each

C-2/C-22 Cable w/Drop Head Auger :

RIDGID

- 5/16" x 25'/50'
- For drain lines 3/4" to 1-1/2"
- Especially good for back-to-back mounted fixtures and severe bends
- For K-40, K39-5 and K-50 machines



Item #	U/M	Model #	Length
M22022	Each	C-2	25'
M22079	Each	C-22	50'

C-4/C-6 Cable w/Male Coupling :

RIDGID

- 3/8" x 25'/35'
- For drain lines 1-1/4 to 2-1/2"
- Ideal for kitchen sinks, lavatory sinks, slop sinks, and disposal waste lines
- For K-40, K-39-5 and K-50 machines



Item #	U/M	Model #	Length
M22024	Each	C-4	25'
M22032	Each	C-6	35'

C-5 Cable w/Bulb Auger :

RIDGID

- 3/8" x 35', with bulb auger
- For drain lines 1-1/4" to 2-1/2"
- Ideal for kitchen sinks, lavatory sinks, slop sinks, and disposal waste lines
- For K-40, K-39-5 and K-50 machines



Item # M22028
U/M-Each

C-7 Cable w/Tight Wind :

RIDGID

- 5/8" x 7-1/2'
- For 2" and 3" floor drains
- Tight wind cable providing good rigidity in a hollow core cable.
- Not for tree roots
- For K-50 machine only



Item # M22036
U/M-Each

C-8 Cable w/All-Purpose Wind :

RIDGID

- 5/8" x 7-1/2'
- For drains 1-1/4" to 2"
- Ideal for proper cleaning of small lines
- More flexible than C-7
- For K-50 machine only



Item # M22040
U/M-Each

Adapter :

- A-17-A Adapter has 25' of 5/16" cable with bulb auger
- A-17-B Adapter has 35' of 3/8" cable with bulb auger

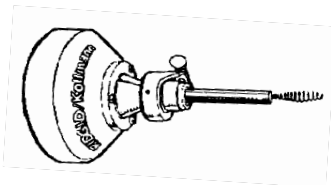

Item #	U/M	Mfg#
M21996	Each	A-17-A
M22000	Each	A-17-B

A-30 Cable Kit :

RIDGID

- Kit includes, includes 6 sections of C-8 (5/8"x7-1/2') cable, 1ea T-201, T-202, T-205, T-211 augers, 1ea A-13 Pin key, 1ea A-10 cable carrier, 1ea A-14-6 rear guide hose and 1ea A-1 left hand mitt

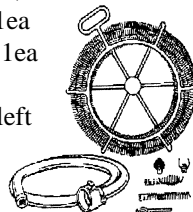

Item # M22008
U/M-Each

Cable Rust Inhibitor :

RIDGID

- Superior rust preventative
- Designed exclusively for drain cleaning cables and rods
- Preserves and protects, eases effort
- Lightly scented
- 1 gallon container



Item # M22018
U/M-Each



Plumbing

PLUMBING

Pedestal Sump Pump :

- ABS Thermoplastic base
- 1-1/4" discharge outlet
- 1/3 HP
- U.L. Listed
- High capacity 50 GPM

PERFORMANCE TABLE (in gallons per minute)

VERTICAL PUMPING DISTANCE IN FEET							
6'	8'	10'	12'	14'	16'	18'	
50	45	39	32	23	13	2	

Myers®

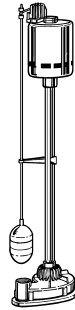

Item # M97552
U/M - Each

3/10 HP Submersible Sump Pump :

- Sturdy thermoplastic housing
- Pumps up to 2,400 GPH
- Top suction filters debris
- High capacity 1-1/2" discharge

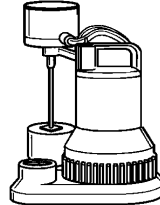

Item # M97554
U/M - Each

Sump Pump Check Valve :

- Prevent backflow of water
- Made of durable vinyl material
- 1-1/4" Male pipe thread

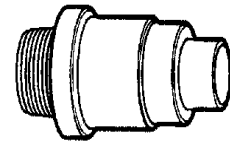

Item # M97578
U/M - Each

Faucet Handle Puller :

- Hardened steel faucet handle puller
- Removes all hooded type and all cross and lever handles easily and quickly

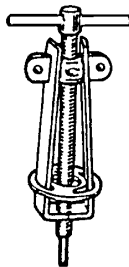

Item # M99025
U/M - Each

4 Way Key Wrench :

- For valve faucets, sill cocks
- 1/4", 9/32", 5/16", 11/32" square stems

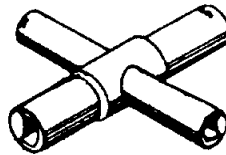

Item # M99031
U/M - Each

Moen Cartridge Puller :

- For Moen stems and Moen cartridges from faucets and shower valves

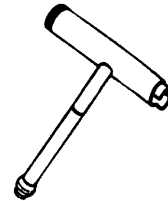

Item # M99057
U/M - Each

Basin Wrench :

- Made of drop forged steel with hardened teeth
- May be opened either to the right or to the left
- Spring loaded jaws
- 11" Long

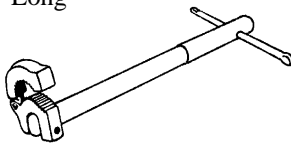

Item # M99008
U/M - Each

Adjustable Basin Wrench :

- Adjustable 9"-15"
- Forged alloy steel jaws, hardened jaws
- Spring loaded jaws

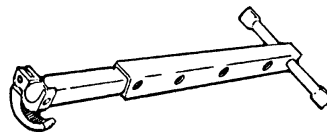

Item # M99015
U/M - Each

Strainer Lock Nut Wrench :

- Chrome finish
- For removing strainer lock nuts
- Hardened steel



Item # M99009
U/M - Each



MILL SUPPLY CO., INC.

Phone (410) 485-3343
Fax (410) 325-2240

Toll Free 1-800-817-8183

Plumbing

PLUMBING TOOLS & FLUX

All-Purpose Wrench :

- Fits spuds, slip nut, lock nuts
- Adjusts to 3"

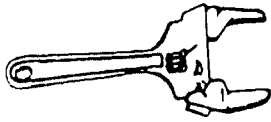

Item # M99026
U/M - Each

Strainer Wrench :

- For installation of bath tub drain and kitchen sink basket strainers
- Chrome plated

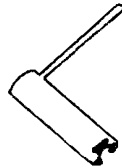

Item # M99010
U/M - Each

4-Piece Seat Wrench Set :

- For easy removable and installation of faucet seats
- Includes ratchet wrench
- 4pc. set

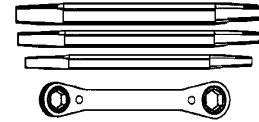

Item # M99016
U/M - Each

Angle Seat Wrenches :

- 6" x 6" hardened steel
- 3 Hex sizes on one end, and 3 square on the other



Item #	U/M	Description
M99022	Each	Stepped Ends
M99019	Each	Tapered Ends

Socket Wrench Set :

- 7 Piece set
- Permits easy access to recessed valve stem
- Eliminates chipped tile around valve stem opening

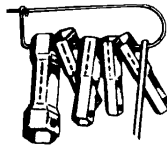

Item # M99035
U/M - Each

Water Heater Element Removal Tool :

- Reaches into offsets
- Works with any screwdriver

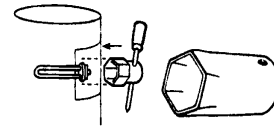

Item # M99006
U/M - Each

Acid Brush :

- 6" long
- 1/2" wide
- Filled with horse hair

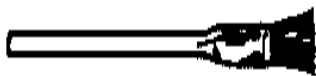

Item # M92804
U/M - Each

Fitting Brushes :

- Plastic handle and high carbon crimped steel brush
- Ideal for plumbing and refrigeration applications



Item #	U/M	Size
M92809	Each	1/2"
M92812	Each	3/4"
M92815	Each	1"
M92818	Each	1-1/4"
M92819	Each	2"



Plumbing

BRAZING / SOLDERING SUPPLIES

Propane Cylinder :

- 14.1oz.
- Disposable



BERNZOMATIC®

Item # M24318
U/M - Each

Mapp Gas Cylinder :

- 16oz.
- Burns hotter than propane
- Disposable



BERNZOMATIC®

Item # M24319
U/M - Each

Pencil Flame Torch Head :

- Better quality, all brass torch
- 3X heat output of utility torches
- Produces a 1/2" pencil point flame for detail work

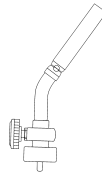

BERNZOMATIC®

Item # M24276
U/M - Each

Pencil Flame Torch Kit :

- Includes a 14.1oz. propane cylinder and a pencil flame torch head



BERNZOMATIC®

Item # M24324
U/M - Each

Trigger Start Propane Torch Kit :

- Includes a 14.1oz. propane cylinder and a trigger start head



BERNZOMATIC®

Item # M24270
U/M - Each

Butane Lighter :

- Refillable
- Adjustable flame control



BERNZOMATIC®

Item # M24316
U/M - Each

Wire Solder :

- 100% lead free
- Premium quality
- NSF certified
- 1lb.

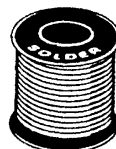

Item # M99991
U/M - Each



MILL SUPPLY CO., INC.

Phone (410) 485-3343
Fax (410) 325-2240

Toll Free 1-800-817-8183

Page 303

Plumbing

PLUMBING ACCESSORIES

Plumbers Grease :

- Makes hard turning faucets work smoothly
- Lubricates stems of faucets, valves, ballcocks, etc.
- Waterproof
- 1/2oz. container



Item # M99988
U/M - Each

Pipe Joint Compound :

- 8oz. container
- A soft set, non-hardening, smooth, grit-free, gray colored pipe joint for all types of metal connections



Item # M99958
U/M - Each

Plastic Pipe Cement :

- Medium setting cement for PVC pipe and fittings



Item #	U/M	Size
M99964	Each	8 oz.
M99968	Each	Pint

Plastic Pipe Cleaner :

- Cleans plastic pipe prior to cementing
- Includes plastic dauber brush
- 8oz.



Item # M99972
U/M - Each

Soldering Paste :

- For use on on all metals except aluminum
- Cleans as it fluxes to assure complete bonding of solder and metal



Item #	U/M	Size
M99996	Each	2 oz.
M99998	Each	1 lb.

Epoxy Putty :

- Hardens like steel in 20 minutes
- Plugs, seals, mends and patches practically anything
- Can be used under water
- 4 oz. stick



Item # M99971
U/M - Each

Plumbers Putty :

- For setting closet bowls, sink strainers, etc.
- Has excellent adhesive qualities



Item #	U/M	Size
M99952	Each	14 oz.
M99954	Each	5 lb.

Thrift :

- For drains, grease traps, septic systems and root control
- Odorless
- Will not harm plumbing or septic systems



Item # M66080
U/M - Each

Liquid Drain Opener :

- Concentrated, 97% sulfuric acid drain opener
- Dissolves hair, cotton, paper and most organic matter, and some inorganic matter that may cause drain clogging
- Includes protective gloves and apron
- For professional use only
- 1 quart



Item # M66081
U/M - Each

Drano Liquid Drain Opener :

- Opens drains quickly by attacking tough grease-based clogs, even through standing water
- Will not harm septic tanks or cesspools
- 32oz. bottle



Item # M66083
U/M - Each



MILL SUPPLY CO., INC.

Phone (410) 485-3343
Fax (410) 325-2240

Toll Free 1-800-817-8183

Plumbing

PLUMBING ACCESSORIES

Stop & Waste Valves :

- Brass body, cast iron handles

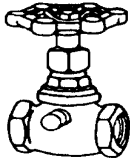

Item #	U/M	Description	Size
M99671	Each	Threaded ends	1/2"
M99672	Each	Threaded ends	3/4"
M99676	Each	Solder ends	1/2"
M99677	Each	Solder ends	3/4"

Gate Valves :

- Brass body, cast iron handles
- Designed for use in a fully opened or closed position



Item #	U/M	Description	Size
M99544	Each	Threaded ends	1/2"
M99545	Each	Threaded ends	3/4"
M99556	Each	Solder ends	1/2"
M99557	Each	Solder ends	3/4"
M99558	Each	Solder ends	1"
M99661	Each	Solder ends	2"

Ball Valves :

- 400 PSI (Water, oil, or gas)
- Chrome plated solid brass ball
- Quarter turn operation
- Brass body
- Teflon seats

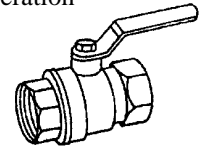

Item #	U/M	Description	Size
M99505	Each	Threaded ends	1/2"
M99506	Each	Threaded ends	3/4"
M99522	Each	Sweat ends	1/2"
M99523	Each	Sweat ends	3/4"
M99524	Each	Sweat ends	1"

Ice Maker Installation Kit :

- Kit includes: self tapping valve, tubing and all necessary brass fittings

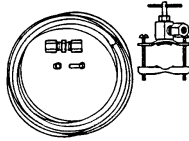

Item #	Tubing Type
M99768	25' polyethylene
M99772	15' Copper

Hard Copper Water Tubing :

- For plumbing, heating, and industrial use
- 10 ft. lengths

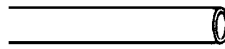

Item #	U/M	Type	Size
M99155	Each	"M"	1/2"
M99157	Each	"M"	3/4"
M99179	Each	"L"	1/2"
M99180	Each	"L"	3/4"

Soft Copper Water Tubing :

- Type "L"
- 60' Coil
- 1/4" Actual O.D.

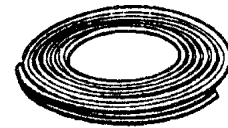

Item # M99140
U/M-Each

Pipe Repair Clamps :

- With rubber gaskets, 2 bolts and 2 nuts
- Galvanized

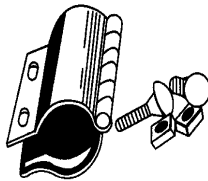

Item #	U/M	Size
M98909	Each	1/2"
M98913	Each	3/4"
M98915	Each	1"
M98921	Each	1-1/4"
M98923	Each	1-1/2"

Hanger Straps :

- Incorporates a special design which allows for pipe expansion
- Can be used on copper



Item #	U/M	Size
M95995	Each	1/2"
M95996	Each	3/4"

Thermocouplers :

- For use in gas water heaters, gas furnaces, gas space heaters and gas logs
- Replaces most common thermocouplers

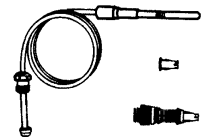

Item #	U/M	Size
M93406	Each	18"
M93412	Each	24"
M93418	Each	36"
M93424	Each	48"



MILL SUPPLY CO., INC.

Phone (410) 485-3343
Fax (410) 325-2240

Toll Free 1-800-817-8183

Page 305

Plumbing

PVC SCHEDULE 40 FITTINGS

Coupling :

- Slip x Slip
- Sold by the each



Item #	U/M	Size
M93652	Each	1/2"
M93653	Each	3/4"
M93654	Each	1"
M93655	Each	1-1/4"
M93656	Each	1-1/2"
M93657	Each	2"

Female Adapter :

- Slip x Female Pipe Thread
- Sold by the each

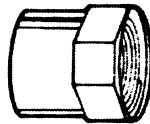

Item #	U/M	Size
M93659	Each	1/2"
M93660	Each	3/4"
M93661	Each	1"
M93662	Each	1-1/4"
M93663	Each	1-1/2"
M93664	Each	2"

Male Adapter :

- Slip x Male Pipe Thread
- Sold by the each



Item #	U/M	Size
M93666	Each	1/2"
M93667	Each	3/4"
M93668	Each	1"
M93669	Each	1-1/4"
M93670	Each	1-1/2"
M93671	Each	2"

45 Degree Elbow :

- Slip x Slip
- Sold by the each



Item #	U/M	Size
M93673	Each	1/2"
M93674	Each	3/4"
M93675	Each	1"
M93676	Each	1-1/4"
M93677	Each	1-1/2"
M93678	Each	2"

90 Degree Elbow :

- Slip x Slip
- Sold by the each

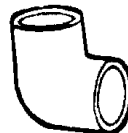

Item #	U/M	Size
M93680	Each	1/2"
M93681	Each	3/4"
M93682	Each	1"
M93683	Each	1-1/4"
M93684	Each	1-1/2"
M93685	Each	2"

Tee :

- Slip
- Sold by the each

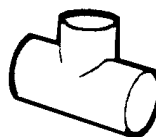

Item #	U/M	Size
M93687	Each	1/2"
M93688	Each	3/4"
M93689	Each	1"
M93690	Each	1-1/4"
M93691	Each	1-1/2"
M93692	Each	2"

Tubing :

- 10 foot lengths
- Sold by the each

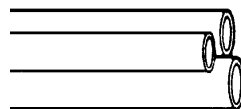

Item #	U/M	Size
M99103	Each	1/2"
M99105	Each	3/4"
M99107	Each	1"
M99109	Each	1-1/4"
M99111	Each	1-1/2"
M99115	Each	2"



Plumbing

PVC FLEXIBLE TUBULAR

1-1/2" Flexible "J" Bend :

- 1-1/2" x 1-1/2" or 1-1/2" x 1-1/4"
- Includes reducing washer

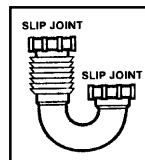
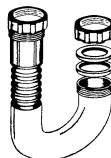

Item # M93697
U/M - Each

1-1/2" Flexible Kitchen Sink Trap :

- 1-1/2" x 1-1/2" or 1-1/2" x 1-1/4"
- Includes reducing washer

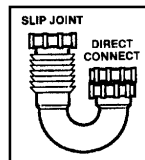
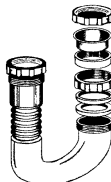

Item # M93698
U/M - Each

1-1/2" Flexible Coupling :

- Can be used as an elbow
- 1-1/2" x 1-1/2" or 1-1/2" x 1-1/4"
- Includes reducing washer

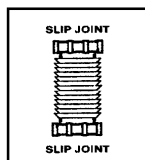

Item # M93699
U/M - Each

1-1/2" Flexible Tailpiece :

- Flanged, with captive nut
- Connects directly to strainer
- 1-1/2" x 12"

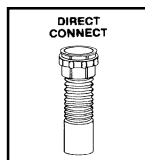
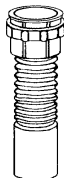

Item # M93700
U/M - Each

1-1/2" Flexible Extension Tube :

- With slip joint nut and washer
- 1-1/2" x 12"

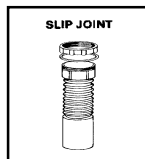
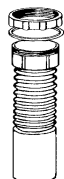

Item # M93702
U/M - Each

1-1/4" Flexible Extension Tube :

- With slip joint nut and washer
- 1-1/4" x 8"

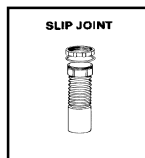
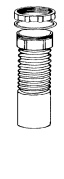

Item # M93701
U/M - Each

Slip Joint Nut :

- Can be attached without tools



Item #	U/M	Size
M93711	Each	1-1/4"
M93712	Each	1-1/2"



MILL SUPPLY CO., INC.

Phone (410) 485-3343
Fax (410) 325-2240

Toll Free 1-800-817-8183

Page 307

Plumbing

PVC / ABS TRAPS & FITTINGS

PVCP-Trap :

- DWV PVC
- All hub



Item #	U/M	Size
M93721	Each	1-1/2"
M93724	Each	2"

PVCP-Trap LA Pattern :

- DWV PVC
- SJ x H
- Furnished with both size SJ washers
- 1-1/4" x 1-1/2" or 1-1/2" x 1-1/2"

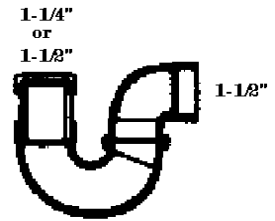

Item # M93723
U/M - Each

PVCP-Trap w/Union Joint :

- DWV PVC
- All hub
- 1-1/2"

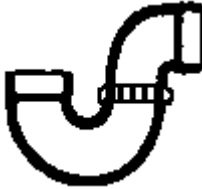

Item # M93722
U/M - Each

PVC 45 Degree Wye :

- DWV PVC
- All hub

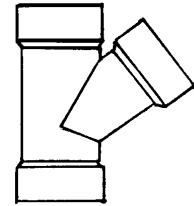

Item #	U/M	Size
M93732	Each	1-1/2"
M93733	Each	2"

PVC Trap Adapters :

- DWV PVC
- Slip side comes with 1-1/2" regular washer, and PVC slip nut
- Adapts tubular to PVC/DWV
- 1-1/2"
- (A) Hub x Slip
- (B) Spigot x Slip

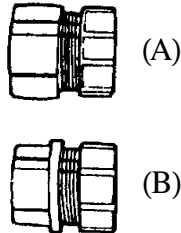

Item #	U/M	Type
M93751	Each	(A) Female
M93754	Each	(B) Male

ABS P-Trap :

- For kitchen or lavatory drain
- 1-1/2" trap includes 1-1/2" to 1-1/4" reducing washer

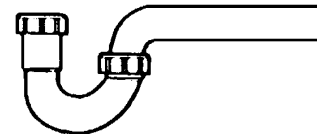

Item #	U/M	Size
M93770	Each	1-1/4"
M93771	Each	1-1/2"

ABS J-Bend :

- 1-1/2"
- Includes 1-1/2" to 1-1/4" reducing washer

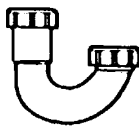

Item # M93776
U/M - Each

ABS Extension Tube :

- Includes slip joint nut and reducing washer
- 1-1/2" x 8"



Item # M93760
U/M - Each

ABS Tailpiece :

- 12" is flanged on one end
- 16" is flanged on both ends



Item #	U/M	Size
M93765	Each	1-1/2" x 12"
M93766	Each	1-1/2" x 16"



MILL SUPPLY CO., INC.

Phone (410) 485-3343
Fax (410) 325-2240

Toll Free 1-800-817-8183

Plumbing

WROUGHT COPPER FITTINGS

Coupling :

- Less stop
- Copper to Copper

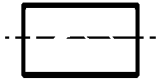

Item #	U/M	Size
M95908	Each	1/4"
M95909	Each	3/8"
M95910	Each	1/2"
M95911	Each	3/4"
M95912	Each	1"
M95913	Each	1-1/4"
M95914	Each	1-1/2"

Coupling :

- With stop
- Copper to Copper

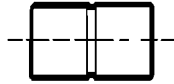

Item #	U/M	Size
M95901	Each	1/4"
M95902	Each	3/8"
M95903	Each	1/2"
M95904	Each	3/4"
M95905	Each	1"
M95906	Each	1-1/4"
M95907	Each	1-1/2"

Male Adapter :

- Copper to Male N.P.T.

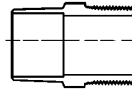

Item #	U/M	Size
M95934	Each	1/4"
M95935	Each	3/8"
M95936	Each	1/2"
M95937	Each	3/4"
M95938	Each	1"
M95939	Each	1-1/4"
M95940	Each	1-1/2"

Cap :

- For Tube End



Item #	U/M	Size
M95984	Each	1/4"
M95985	Each	3/8"
M95986	Each	1/2"
M95987	Each	3/4"
M95988	Each	1"
M95989	Each	1-1/4"
M95990	Each	1-1/2"

90 Degree Elbow :

- Copper to Copper

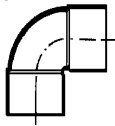

Item #	U/M	Size
M95955	Each	1/4"
M95956	Each	3/8"
M95957	Each	1/2"
M95958	Each	3/4"
M95959	Each	1"
M95960	Each	1-1/4"
M95961	Each	1-1/2"

45 Degree Elbow :

- Copper to Copper



Item #	U/M	Size
M95944	Each	1/4"
M95945	Each	3/8"
M95946	Each	1/2"
M95947	Each	3/4"
M95948	Each	1"
M95949	Each	1-1/4"
M95950	Each	1-1/2"

Tee :

- Copper to Copper to Copper

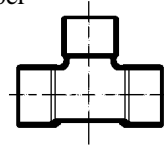

Item #	U/M	Size
M95973	Each	1/4"
M95974	Each	3/8"
M95975	Each	1/2"
M95976	Each	3/4"
M95977	Each	1"
M95978	Each	1-1/4"
M95979	Each	1-1/2"

Reducing Coupling :

- Copper to Copper

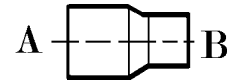

Item #	U/M	Size (AxB)
M95916	Each	3/8" x 1/4"
M95917	Each	1/2" x 3/8"
M95918	Each	3/4" x 1/2"
M95919	Each	1" x 3/4"
M95920	Each	1-1/4" x 1"
M95921	Each	1-1/2" x 1-1/4"

45 Degree Street Elbow :

- Fitting to Copper

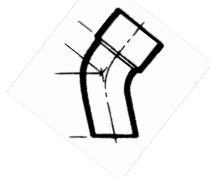

Item #	U/M	Size
M95952	Each	1/2"
M95954	Each	3/4"

90 Degree Street Elbow :

- Fitting to Copper

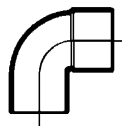

Item #	U/M	Size
M95963	Each	1/2"
M95964	Each	3/4"

Reducing Female Adapter :

- Copper to Female N.P.T.

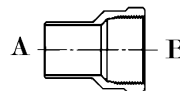

Item #	U/M	Size (AxB)
M95931	Each	3/8" x 1/2"
M95932	Each	3/4" x 1/2"

Reducing Male Adapter :

- Copper to Male N.P.T.

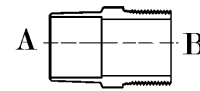

Item #	U/M	Size (AxB)
M95941	Each	3/8" x 1/2"
M95942	Each	1/2" x 3/4"

All Sizes Are Nominal

All Sizes Are Nominal



MILL SUPPLY CO., INC.

Phone (410) 485-3343
Fax (410) 325-2240

Toll Free 1-800-817-8183

Plumbing

BLACK MALLEABLE FITTINGS

Floor & Ceiling Plates :

- Chrome finish
- Sold by the each



Item #	U/M	Fits
M92570	Each	1/2" Copper Tube
M92571	Each	3/4" Copper Tube
M92576	Each	1/2" Iron Pipe
M92579	Each	1" Iron Pipe

Pipe Nipples :

- Black steel
- Sold by the each

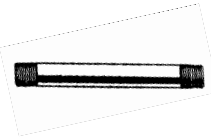

Item #	U/M	Size
M95392	Each	1/2" x CLS
M95393	Each	1/2" x 1-1/2"
M95394	Each	1/2" x 2"
M95395	Each	1/2" x 2-1/2"
M95396	Each	1/2" x 3"
M95397	Each	1/2" x 3-1/2"
M95398	Each	1/2" x 4"
M95399	Each	1/2" x 4-1/2"
M95400	Each	1/2" x 5"
M95402	Each	1/2" x 6"
M95406	Each	1/2" x 8"
M95410	Each	1/2" x 12"
M95411	Each	3/4" x CLS
M95412	Each	3/4" x 1-1/2"
M95413	Each	3/4" x 2"
M95414	Each	3/4" x 2-1/2"
M95415	Each	3/4" x 3"
M95417	Each	3/4" x 4"
M95421	Each	3/4" x 6"

Malleable Plug :

- Black iron
- Sold by the each

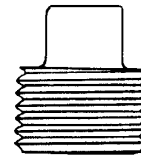

Item #	U/M	Size
M95470	Each	1/2"
M95471	Each	3/4"

90 Degree Banded Elbow :

- Black iron
- Sold by the each

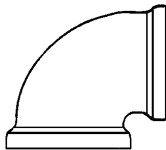

Item #	U/M	Size
M95428	Each	1/2"
M95429	Each	3/4"

45 Degree Banded Elbow :

- Black iron
- Sold by the each

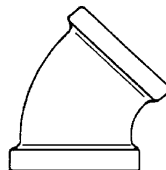

Item #	U/M	Size
M95434	Each	1/2"
M95435	Each	3/4"

90 Degree Street Elbow :

- Black iron
- Sold by the each

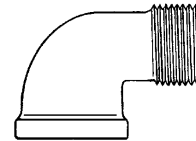

Item #	U/M	Size
M95431	Each	1/2"
M95432	Each	3/4"

Banded Tee :

- Black iron
- Sold by the each

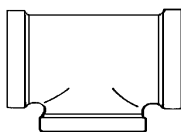

Item #	U/M	Size
M95439	Each	1/2"
M95440	Each	3/4"

Banded Coupling :

- Black iron
- Sold by the each

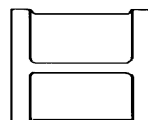

Item #	U/M	Size
M95453	Each	1/2"
M95454	Each	3/4"

Union :

- Black iron
- Sold by the each

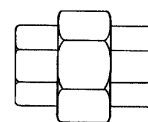

Item #	U/M	Size
M95448	Each	1/2"
M95449	Each	3/4"





Index - Item

INDEX - ITEM NUMBER

Item #	Page #	Item #	Page #	Item #	Page #	Item #	Page #
M10019	18	M13061	7	M14128	8	M15226	30
M10022	19	M13066	7	M14130	8	M15227	30
M10029	19	M13070	7	M14133	8	M15240	30
M10032	19	M13078	7	M14136	9	M15250	30
M10040	18,250	M13090	7	M14139	9	M15253	30
M10044	18,250	M13093	7	M14140	9	M15256	30
M10060	19	M13096	7	M14141	12	M15301	31
M10070	18	M13100	7	M14239	12	M15309	31
M10084	17	M13102	7	M14240	12	M15317	31
M10090	17	M13108	7	M14241	12	M15503	31
M10096	17	M13112	7	M14242	12	M15509	29
M10105	17	M13119	7	M14246	12	M15603	39
M10110	18	M13124	7	M14506	13	M15606	39
M10130	18	M13126	7	M14518	13	M15612	39
M10132	18	M13151	7	M14530	13	M15623	39
M10134	18	M13153	7	M14542	13	M15687	38
M10136	18	M13156	7	M14545	13	M15690	38
M10140	19	M13162	7	M14566	13	M15693	38
M10154	154	M13186	6	M14578	13	M15705	38
M10158	154	M13188	6	M14653	13	M15706	38
M10160	154	M13198	6	M14656	13	M15720	104
M12003	213	M13204	6	M14659	13	M15725	38
M12011	213	M13210	6	M14662	13	M15853	38
M12015	213	M13214	6	M14670	74	M15856	38
M12027	213	M13216	6	M14673	74	M15859	38
M12048	214	M13222	6	M14676	74	M15862	38
M12076	213	M13228	6	M14777	13	M15865	38
M12079	213	M13355	3	M14781	13	M16021	35
M12252	40	M13361	3	M14784	13	M16022	36
M12256	40	M13364	3	M15023	31	M16024	36
M12258	40	M14014	11	M15026	31	M16027	36
M12275	40	M14023	10	M15029	31	M16030	36
M12284	40	M14027	10	M15032	31	M16033	36
M12521	26	M14033	10	M15035	31	M16042	36
M12536	26	M14036	10	M15038	31	M16043	36
M13004	6	M14039	10	M15103	32	M16048	33
M13006	6	M14041	10	M15109	32	M16051	33
M13008	6	M14047	10	M15118	32	M16053	33
M13009	6	M14072	11	M15153	29	M16057	35
M13011	6	M14073	11	M15156	29	M16060	35
M13014	6	M14076	11	M15159	29	M16063	35
M13017	6	M14104	8	M15162	29	M16066	35
M13018	6	M14106	8	M15165	29	M16069	35
M13024	6	M14109	8	M15168	29	M16072	35
M13030	6	M14115	8	M15171	29	M16075	35
M13032	6	M14117	8	M15172	29	M16078	33
M13036	6	M14118	8	M15176	29	M16081	33
M13042	6	M14124	9	M15177	29	M16082	34
				M15225	30	M16083	34



INDEX - ITEM NUMBER

Item #	Page #	Item #	Page #	Item #	Page #	Item #	Page #
M16084	34	M16893	22	M18529	16	M18775	12
M16085	34	M16913	20	M18533	16	M18782	12
M16090	34	M16931	22	M18536	16	M18783	12
M16093	34	M16952	22	M18539	16	M18784	12
M16108	34	M17060	23	M18544	16	M18785	141
M16113	35	M17072	23	M18546	16	M18793	141
M16115	36	M17078	23	M18549	16	M18801	141
M16117	33	M17132	23	M18553	16	M18821	140
M16202	37	M17204	22	M18559	16	M18825	140
M16203	37	M17208	22	M18561	16	M18829	140
M16206	37	M17211	22	M18563	16	M18881	12
M16209	37	M17215	22	M18569	14	M18885	12
M16212	37	M17219	22	M18573	14	M18890	12
M16213	37	M17223	22	M18581	14	M18901	14
M16250	37	M17227	22	M18585	14	M18904	14
M16253	37	M17513	24	M18589	14	M18905	14
M16256	37	M17519	24	M18593	14	M18906	14
M16259	37	M17525	24	M18599	14	M18951	16
M16262	37	M17531	24	M18601	14	M18952	16
M16265	37	M17537	24	M18603	15	M18953	16
M16272	37	M17543	24	M18607	15	M18954	16
M16275	37	M17549	24	M18611	15	M18955	16
M16278	37	M17555	24	M18613	14	M18956	16
M16281	37	M17756	25	M18617	14	M18957	16
M16285	37	M17757	25	M18621	14	M19001	17
M16289	37	M17768	25	M18625	14	M19010	17
M16503	20	M17774	25	M18649	113	M19016	17
M16505	20	M17779	25	M18653	113	M19103	17
M16554	21	M17786	25	M18655	113	M15115	17
M16555	21	M17816	25	M18665	14	M19123	17
M16556	21	M18002	5	M18673	14	M19127	17
M16559	21	M18003	5	M18675	14	M19143	17
M16565	21	M18006	5	M18681	14	M19150	17
M16573	21	M18013	5	M18683	14	M19159	17
M16624	20	M18019	5	M18693	14	M19167	17
M16625	20	M18025	5	M18725	15	M19175	17
M16739	21	M18031	5	M18729	15	M19195	17
M16745	21	M18055	5	M18732	15	M20068	63
M16747	21	M18061	5	M18735	15	M20077	64
M16757	20	M18062	5	M18739	15	M20086	63,64
M16769	20	M18075	5	M18742	15	M20095	63
M16859	22	M18076	5	M18743	15	M20104	63
M16865	22	M18088	5	M18753	15	M20113	62
M16871	22	M18508	16	M18761	15	M20122	57
M16877	22	M18509	16	M18763	15	M20131	56
M16883	22	M18514	16	M18764	15	M20140	56
M16889	22	M18517	16	M18772	12	M20149	56
M16891	22	M18525	16	M18774	12	M20158	57



INDEX - ITEM NUMBER

Item #	Page #	Item #	Page #	Item #	Page #	Item #	Page #
M20167	57	M20607	85	M21176	64	M22022	300
M20176	56	M20616	85	M21188	64	M22024	300
M20185	56	M20625	85	M21408	65	M22028	300
M20194	57	M20634	85	M21416	65	M22032	300
M20203	83	M20643	85	M21424	72	M22036	300
M20204	83	M20652	86	M21431	66	M22040	300
M20205	83	M20661	85	M21432	66	M22052	299
M20206	83	M20662	85	M21440	75	M22056	299
M20207	83	M20668	85	M21445	75	M22060	299
M20208	83	M20670	85	M21448	65	M22064	299
M20209	83	M20679	85	M21456	65	M22068	299
M20210	83	M20697	85	M21471	75	M22072	299
M20211	83	M20706	85	M21472	75	M22074	299
M20256	84	M20715	85	M21488	71	M22076	29
M20265	84	M20724	85	M21490	71	M22079	300
M20274	84	M20733	85	M21504	72	M22081	298
M20280	73	M20742	88	M21512	71	M22082	298
M20283	73	M20751	90	M21520	62	M22088	69
M20292	73	M20798	89	M21528	71	M22092	69
M20295	73	M20799	89	M21536	72	M22104	69
M20301	75	M20802	78	M21544	70	M22110	69
M20328	77	M20804	78	M21598	193	M22112	69
M20337	77	M20805	78	M21748	86	M22119	69
M20346	77	M20811	88	M21808	69	M23548	88
M20355	77	M21004	70	M21816	90	M23549	88
M20382	80	M21012	70	M21820	90	M23550	88
M20391	80	M21016	70	M21824	90	M23551	88
M20400	80	M21018	70	M21828	90	M23560	88
M20409	80	M21020	70	M21832	90	M23561	88
M20418	80	M21031	70	M21836	90	M23720	76
M20427	81	M21032	70	M21840	90	M23721	76
M20436	81	M21050	70	M21869	69	M23722	76
M20445	81	M21052	70	M21916	69	M23723	76
M20454	81	M21064	71	M21948	69	M23724	76
M20463	81	M21065	71	M21964	80	M23725	76
M20472	81	M21068	70	M21972	298	M23726	76
M20481	81	M21091	70	M21976	298	M23727	76
M20490	81	M21092	70	M21978	298	M23728	76
M20499	82	M21096	71	M21980	298	M23729	76
M20508	82	M21099	70	M21984	299	M23730	76
M20535	82	M21100	71	M21992	299	M23731	76
M20544	82	M21104	73	M21996	300	M23732	76
M20553	82	M21108	65	M22000	300	M23733	76
M20562	84	M21116	64	M22004	299	M23734	76
M20571	82	M21120	64	M22008	300	M23735	76
M20580	83	M21124	64	M22016	298	M23736	76
M20589	83	M21136	63,64	M22018	300	M23737	76
M20598	84	M21160	65	M22020	300	M23738	76



INDEX - ITEM NUMBER

Item #	Page #	Item #	Page #	Item #	Page #	Item #	Page #
M23739	76	M24609	89	M28863	61	M29127	90
M23740	76	M24614	89	M28869	61	M29128	90
M23741	76	M24627	89	M28872	61	M29129	90
M23742	76	M24633	66	M28875	61	M29130	90
M23743	76	M24634	66	M28878	61	M29132	90
M23744	76	M24645	67	M28879	61	M29134	90
M23745	76	M24646	67	M28881	61	M29135	90
M23746	76	M24748	75	M28884	61	M29140	87
M24017	78	M24793	50	M28887	62	M29141	87
M24018	78	M24919	59	M28890	55	M29143	87
M24028	77	M24920	59	M28893	55	M29145	87
M24029	78	M24925	59	M28896	55	M29147	87
M24031	77	M24929	59	M28899	55	M29150	87
M24033	77	M24933	59	M28902	55	M29151	87
M24041	77	M24940	60	M28905	55	M29153	87
M24042	79	M25007	92	M28908	55	M29155	87
M24048	79	M25026	92	M28911	55	M29157	87
M24054	79	M25047	91	M28914	55	M29159	87
M24055	79	M25045	92	M28917	55	M29161	87
M24060	78	M25049	91	M28920	55	M29163	87
M24099	86	M25051	93	M28923	55	M29165	87
M24126	68	M25053	92	M28926	55	M29167	87
M24192	79	M25055	94	M28929	55	M29169	87
M24216	57	M25057	94	M28932	55	M29170	87
M24223	57	M25059	94	M28935	55	M29173	87
M24270	303	M25061	94	M28938	55	M29176	86
M24276	303	M25064	93	M28941	55	M29182	50
M24313	86	M25083	93	M28944	55	M29183	50
M24316	303	M25102	93	M28947	55	M29184	50
M24318	303	M26314	91	M28950	55	M29185	50
M24319	303	M26335	91	M28953	55	M29186	50
M24324	303	M28807	58	M28956	55	M29187	50
M24348	68	M28808	58	M28959	55	M29188	50
M24354	68	M28809	58	M28962	55	M29189	50
M24360	68	M28812	58	M28965	55	M29190	50
M24366	67	M28815	58	M28968	55	M29191	50
M24372	68	M28818	58	M28971	55	M29192	50
M24378	68	M28821	58	M28974	55	M29193	50
M24456	67	M28824	58	M28977	55	M29194	50
M24509	89	M28827	58	M28996	54	M29195	50
M24510	89	M28830	58	M28998	54	M29196	50
M24511	88	M28833	58	M29001	54	M29197	50
M24512	88	M28836	60	M29006	62	M29198	50
M24513	88	M28848	60	M29011	62	M29199	50
M24519	88	M28854	61	M29012	63	M29200	50
M24577	67	M28857	61	M29013	62,64,71,72	M29212	49
M24585	67	M28860	61	M29119	183	M29213	49
M24591	89	M28862	61	M29126	90	M29301	46



INDEX - ITEM NUMBER

Item #	Page #	Item #	Page #	Item #	Page #	Item #	Page #
M29302	46	M29350	47	M29400	51	M29505	53
M29303	46	M29351	47	M29401	51	M29506	53
M29304	46	M29352	47	M29402	51	M29507	53
M29305	46	M29553	47	M29403	51	M29508	53
M29306	46	M29554	47	M29404	51	M29509	53
M29307	46	M29555	47	M29405	51	M29510	53
M29308	46	M29556	47	M29406	51	M29511	53
M29309	46	M29357	47	M29407	51	M29512	53
M29310	46	M29358	47	M29408	51	M29513	53
M29311	46	M29359	47	M29409	51	M29514	53
M29312	46	M29360	47	M29410	51	M29515	53
M29313	46	M29361	47	M29411	51	M29516	53
M29314	46	M29362	47	M29412	51	M29517	53
M29315	46	M29363	47	M29413	51	M29518	53
M29316	46	M29364	47	M29414	51	M29519	53
M29317	46	M29365	47	M29430	48	M29520	53
M29318	46	M29366	47	M29431	48	M29521	53
M29319	46	M29367	47	M29432	48	M29522	53
M29320	46	M29368	47	M29433	48	M29523	53
M29321	46	M29369	47	M29434	48	M29558	45
M29322	46	M29370	47	M29435	48	M29560	45
M29323	46	M29371	47	M29436	48	M29561	45
M29324	46	M29372	47	M29437	48	M29563	45
M29325	46	M29373	47	M29438	48	M29565	45
M29326	46	M29374	47	M29439	48	M29567	45
M29327	46	M29375	47	M29440	48	M29569	45
M29328	46	M29376	47	M29441	48	M29571	45
M29329	46	M29377	47	M29442	48	M29573	45
M29330	46	M29378	47	M29443	48	M29575	45
M29331	46	M29379	47	M29444	48	M29577	45
M29332	46	M29380	47	M29445	48	M29579	45
M29333	46	M29383	51	M29446	48	M29581	45
M29334	46	M29384	51	M29447	48	M29583	45
M29335	46	M29385	51	M29448	48	M29585	45
M29336	46	M29386	51	M29449	48	M29586	45
M29337	46	M29387	51	M29450	48	M29587	45
M29338	46	M29388	51	M29451	48	M29889	45
M29339	46	M29389	51	M29452	48	M29591	45
M29340	46	M29390	51	M29453	48	M29593	45
M29341	46	M29391	51	M29454	48	M29595	45
M29342	47	M29392	51	M29455	48	M29597	45
M29343	47	M29393	51	M29498	53	M29599	45
M29344	47	M29394	51	M29499	53	M29601	45
M29345	47	M29395	51	M29500	53	M92603	45
M29346	47	M29396	51	M29501	53	M29605	45
M29347	47	M29397	51	M29502	53	M29607	45
M29348	47	M29398	51	M29503	53	M29609	45
M29349	47	M29399	51	M29504	53	M29611	45



INDEX - ITEM NUMBER

Item #	Page #	Item #	Page #	Item #	Page #	Item #	Page #
M29613	45	M29761	54	M31164	120	M31467	124
M29615	45	M29763	54	M31167	120	M31511	125
M29643	52	M29765	54	M31170	120	M31512	125
M29644	52	M29768	54	M31202	121	M31516	125
M29645	52	M29769	54	M31214	121	M31517	125
M29646	52	M29771	54	M31229	121	M31521	125
M29647	52	M29772	54	M31236	121	M31525	125
M29648	52	M29773	54	M31253	121	M31527	125
M29649	52	M30011	118	M31259	121	M31529	125
M29650	52	M30015	118	M31264	121	M31531	125
M29651	52	M30019	118	M31268	121	M31533	125
M29652	52	M31002	119	M31274	121	M31535	125
M29653	52	M31003	119	M31301	122	M31598	126
M29654	52	M31004	119	M31304	122	M31599	126
M29655	52	M31008	119	M31306	122	M31616	126
M29656	52	M31009	119	M31307	122	M31617	126
M29657	52	M31010	119	M31322	122	M31618	126
M29658	52	M31013	119	M31324	122	M32003	135
M29659	52	M31017	119	M31327	122	M32010	135
M29660	52	M31018	119	M31329	122	M32011	135
M29661	52	M31019	119	M31353	122	M32012	135
M29662	52	M31022	119	M31356	122	M32013	135
M29663	52	M31023	119	M31357	122	M32014	135
M29664	52	M31024	119	M31362	122	M32015	135
M29665	52	M31051	119	M31363	122	M32016	135
M29666	52	M31052	119	M31367	122	M32017	135
M29667	52	M31057	119	M31368	122	M32018	135
M29668	52	M31058	119	M31374	122	M32019	135
M29669	52	M31063	119	M31375	122	M32020	135
M29670	52	M31068	119	M31381	122	M32021	135
M29671	52	M31069	119	M31382	122	M32022	135
M29701	53	M31075	119	M31385	122	M32023	135
M29702	53	M31076	119	M31386	122	M32024	135
M29703	53	M31101	120	M31397	122	M32035	129
M29704	53	M31102	120	M31398	122	M32036	129
M29705	53	M31103	120	M31401	123	M32062	129
M29706	53	M31107	120	M31402	123	M32065	129
M29707	53	M31108	120	M31416	123	M32067	129
M29709	53	M31109	120	M31417	123	M32068	129
M29710	53	M31114	120	M31425	123	M32070	129
M29711	53	M31116	120	M31426	123	M32071	129
M29712	53	M31119	120	M31432	123	M32075	129
M29713	53	M31123	120	M31433	123	M32076	129
M29714	53	M31125	120	M31456	124	M32077	129
M29715	53	M31132	120	M31457	124	M32101	129
M29716	53	M31134	120	M31458	124	M32102	129
M29717	53	M31152	120	M31465	124	M32202	128
M29718	53	M31158	120	M31466	124	M32203	128



INDEX - ITEM NUMBER

Item #	Page #	Item #	Page #	Item #	Page #	Item #	Page #
M32204	128	M33034	117	M33528	133	M34178	137
M32206	128	M33069	117	M33529	133	M34253	135
M32207	128	M33070	118	M33530	133	M34256	135
M32208	128	M33075	118	M33553	139	M34264	135
M32219	128	M33076	118	M33556	134	M34267	135
M32220	128	M33077	118	M33559	134	M34270	135
M32221	128	M33078	118	M33565	134	M34281	138
M32225	128	M33079	118	M33568	134	M34286	138
M32231	128	M33080	117	M33580	134	M34294	138
M32236	128	M33081	117	M33586	134	M34297	138
M32242	128	M33085	117	M33589	134	M34301	138
M32249	128	M33087	117	M33595	134	M34304	138
M32250	128	M33091	117	M33619	134	M34401	147
M32267	128	M33092	117	M33622	134	M34403	147
M32268	128	M33097	117	M33625	134	M34407	147
M32269	128	M33099	117	M33628	134	M34413	147
M32284	128	M33102	117	M33637	134	M34416	147
M32289	128	M33453	130	M33640	134	M34419	147
M32292	128	M33454	130	M33643	134	M34421	147
M32293	128	M33455	130	M33652	134	M34424	147
M32294	128	M33456	130	M33658	134	M34427	147
M32305	128	M33457	130	M33660	134	M34430	147
M32306	128	M33459	130	M33661	134	M34433	147
M32307	128	M33463	131	M34003	137	M34439	147
M32312	128	M33464	131	M34017	136	M34441	147
M32313	128	M33465	131	M34028	136	M34444	147
M32314	128	M33470	130	M34035	136	M34472	146
M32323	128	M33471	130	M34039	136	M34511	98
M32331	128	M33472	130	M34042	136	M34513	98
M32339	128	M33473	130	M34046	136	M34518	98
M32347	128	M33474	130	M34053	136	M34524	98
M32402	126	M33475	130	M34054	136	M34527	98
M32403	126	M33481	132	M34060	136	M34530	98
M32405	126	M33482	132	M34067	136	M34535	98
M32416	126	M33483	132	M34074	136	M34537	98
M32417	126	M33484	132	M34081	136	M34544	98
M32418	126	M33485	132	M34098	137	M34568	97
M32433	126	M33486	132	M34101	137	M34571	97
M32434	126	M33491	132	M34105	137	M34596	97
M32435	126	M33492	132	M34122	137	M34599	97
M32451	126	M33493	132	M34133	137	M34603	97
M32452	126	M33494	132	M34136	137	M34615	97,165
M32453	126	M33495	132	M34140	137	M34639	97
M32501	125	M33496	132	M34143	137	M34641	97
M32515	125	M33514	133	M34150	137	M34657	98
M32516	125	M33515	133	M34153	137	M34665	97
M32517	125	M33516	133	M34157	137	M34683	98
M33030	117	M33517	133	M34165	137	M34706	97
M33032	117	M33522	133	M34168	137	M34726	110



INDEX - ITEM NUMBER

Item #	Page #	Item #	Page #	Item #	Page #	Item #	Page #
M34727	110	M35436	114	M35756	101	M35994	116
M34728	110	M35454	114	M35768	101	M35995	116
M34729	110	M35460	114	M35780	101	M35996	116
M34730	110	M35484	114	M35784	101	M35997	116
M34731	110	M35501	114	M35796	101	M35998	116
M34732	110	M35509	113	M35809	101	M35999	116
M34733	110	M35510	114	M35813	101	M36000	116
M34734	110	M35515	113	M35817	101	M36014	143
M34735	110	M35516	113	M35851	100	M36017	143
M34736	110	M35518	113	M35853	100	M36023	143
M34737	110	M35521	113	M35855	100	M36025	143
M34739	110	M35523	113	M35857	100	M36060	143
M34740	110	M35526	113	M35863	100	M36067	143
M34741	110	M35529	113	M35869	100	M36084	143
M34742	110	M35530	113	M35903	100	M36086	143
M34751	111	M35532	113	M35904	100	M37010	143
M34752	111	M35537	113	M35905	100	M37011	143
M34753	111	M35539	113	M35906	100	M37012	143
M34755	112	M35542	113	M35915	100	M37013	143
M34756	111	M35546	113	M35916	100	M37014	143
M34757	111	M35549	113	M35917	115	M37015	143
M34758	111	M35562	101	M35918	115	M37016	143
M34759	111	M35564	101	M35926	115	M37017	143
M34760	111	M35568	101	M35927	115	M37018	143
M34761	111	M35569	101	M35928	115	M37019	143
M34762	111	M35582	101	M35929	115	M37070	143
M34763	112	M35590	101	M35932	115	M37071	143
M34764	112	M35591	101	M35936	115	M37072	143
M34766	112	M35600	101	M35942	115	M37073	143
M34767	112	M35616	101	M35943	115	M37074	143
M34768	111	M35639	101	M35944	115	M37075	143
M34769	111	M35643	101	M35945	115	M37076	143
M34770	112	M35647	101	M35951	115	M37077	143
M34772	111	M35648	101	M35952	115	M37078	143
M34773	112	M35652	101	M35953	115	M37079	143
M34824	141	M35656	101	M35954	115	M38128	140
M34831	139	M35668	101	M35961	115	M38130	140
M34852	114	M35672	101	M35962	115	M38140	140
M34855	114	M35676	101	M35963	115	M38143	140
M34867	114	M35679	101	M35964	115	M38146	140
M34870	139	M35684	101	M35970	116	M38173	140
M34890	139	M35700	101	M35978	116	M38182	140
M34994	139	M35708	101	M38979	116	M38198	140
M34997	114	M35716	101	M35980	116	M38202	140
M35308	114	M35732	101	M35981	116	M38204	140
M35316	114	M35744	101	M35991	116	M38206	140
M35424	114	M35750	101	M35992	116	M38227	140
M35430	114	M35752	101	M35993	116	M38279	141



INDEX - ITEM NUMBER

Item #	Page #	Item #	Page #	Item #	Page #	Item #	Page #
M38286	142	M38938	99	M39386	102	M39716	108
M38287	142	M39003	145	M39394	102	M39718	108
M38307	141	M39005	144	M39402	102	M39720	108
M38311	141	M39007	144	M39410	102	M39724	108
M38317	141	M39009	144	M39418	102	M39726	109
M38319	141	M39011	144	M39426	102	M39728	109
M38321	141	M39026	144	M39468	103	M39730	108
M38331	141	M39028	144	M39478	103	M39731	108
M38333	141	M39061	145	M39482	103	M39734	107
M38335	141	M39107	146	M39492	103	M39736	108
M38341	142	M39111	146	M39493	103	M39738	109
M38345	142	M39118	146	M39507	103	M39739	109
M38351	142	M39120	146	M39509	103	M39740	109
M38355	141	M39122	146	M39517	103	M39742	108
M38357	141	M39124	146	M39519	103	M39748	105
M38363	142	M39126	146	M39526	103	M39750	105
M38365	142	M39128	146	M39528	103	M39752	105
M38369	142	M39133	146	M39529	103	M39754	105
M38371	142	M39135	146	M39553	106	M39756	105
M38414	114	M39137	146	M39555	106	M39760	104
M38502	14	M39139	146	M39558	106	M39762	104
M38504	98	M39145	146	M39564	106	M39764	104
M38506	98	M39147	146	M39565	106	M39768	104
M38508	98	M39149	146	M39566	106	M39772	104
M38510	98	M39151	146	M39578	106	M39774	104
M38512	98	M39165	146	M39579	106	M39776	104
M38514	98	M39167	146	M39581	106	M39780	108
M38552	98	M39169	146	M39586	106	M39782	107
M38553	98	M39171	146	M39587	106	M39788	104
M38554	98	M39173	146	M39588	106	M39790	107
M38556	165	M39177	146	M39604	106	M39792	107
M38584	165	M39258	102	M39608	106	M39796	107
M38585	165	M39266	102	M39654	105	M39798	109
M38599	99	M39270	102	M39656	139	M39800	109
M38656	99	M39274	102	M39657	139	M39802	109
M38657	99	M39282	102	M39664	144	M39810	114
M38659	99	M39290	102	M39666	144	M39823	103
M38673	99	M39298	102	M39668	144	M39825	103
M38688	99	M39306	102	M39674	105	M39829	105
M38733	99	M39314	102	M39680	103	M39831	102
M38811	99	M39322	102	M39682	105	M39833	106
M38814	99	M39330	102	M39699	105	M39847	106
M38829	99	M39338	102	M39702	108	M39879	104
M38914	100	M39346	102	M39704	108	M39880	104
M38916	100	M39354	102	M39708	108	M39881	104
M38929	99	M39362	102	M39710	108	M39965	104
M38932	99	M39370	102	M39712	108	M39966	104
M38935	99	M39378	102	M39714	108	M39967	104



INDEX - ITEM NUMBER

Item #	Page #	Item #	Page #	Item #	Page #	Item #	Page #
M39977	103	M41090	167	M42119	151	M43206	153
M39991	103	M41091	167	M42123	151	M43226	163
M40002	163	M41095	167	M42127	151	M43229	163
M40005	163	M41096	167	M42131	151	M43231	163
M40008	163	M41159	138	M42139	151	M43235	163
M40607	158	M41162	138	M42143	151	M43239	162
M40613	158	M41165	138	M42147	151	M43241	163
M40626	158	M41168	138	M42155	151	M43283	163
M40627	158	M41171	138	M42176	152	M43286	163
M40629	158	M41174	138	M42177	152	M43301	163
M40632	158	M41180	138	M42179	152	M43304	163
M40635	158	M41183	138	M42185	151	M43305	163
M40638	158	M41186	138	M42189	151	M43307	163
M40639	158	M41189	138	M42193	151	M43353	160
M40640	158	M41192	138	M42201	151	M43356	160
M40641	158	M41195	138	M42205	151	M43359	160
M40642	158	M41201	138	M42231	152	M43368	160
M40649	158	M41204	138	M42239	152	M43377	66
M40651	158	M41226	142	M42271	151	M43379	66
M40655	158	M41229	142	M42280	151	M44020	155
M40656	158	M41232	142	M42304	153	M44028	155
M40657	158	M41506	161	M42305	153	M44029	155
M40658	158	M41509	161	M42409	152	M44031	155
M40672	158	M41511	161	M42417	152	M44041	153
M40673	158	M41512	160	M42418	152	M44044	153
M40674	158	M41513	160	M42508	72	M44046	153
M40676	163	M41515	161	M42515	72	M44047	153
M70935	163	M41518	161	M42519	72	M44065	156
M40943	163	M41521	161	M42552	153	M44066	155
M41003	167	M41524	160	M42563	153	M44069	156
M41006	167	M41527	159	M42564	153	M44076	156
M41011	167	M41528	159	M42565	153	M44093	155
M41014	167	M41530	160	M42568	153	M44095	155
M41016	167	M41533	160	M42569	153	M44115	155
M41031	167	M41704	159	M42570	153	M44118	155
M41035	167	M41708	159	M42683	153	M44121	155
M41037	167	M41712	159	M42697	154	M44128	155
M41039	167	M41716	159	M42699	154	M44130	155
M41043	167	M41720	159	M43003	166	M44133	156
M41045	167	M41728	159	M43005	166	M44135	156
M41047	167	M41755	159	M43006	166	M44138	156
M41051	167	M41766	159	M43106	166	M44139	157
M41054	167	M42003	154	M43156	166	M44140	157
M41058	167	M42005	154	M43176	153	M44141	157
M41080	167	M42007	154	M43178	154	M44143	156
M41081	167	M42010	154	M43182	154	M44144	157
M41085	167	M42107	152	M43186	154	M44146	156
M41086	167	M42110	152	M43188	154	M44148	156



INDEX - ITEM NUMBER

Item #	Page #	Item #	Page #	Item #	Page #	Item #	Page #
M44202	157	M46504	174	M46950	169	M47327	168
M44211	163	M46505	174	M46951	169	M47328	168
M44213	162	M46506	174	M46954	169	M47329	168
M44214	162	M46507	174	M46956	169	M47330	168
M44216	157	M46508	174	M46957	169	M47332	168
M44238	157	M46518	174	M46958	169	M47333	168
M44239	157	M46519	174	M46968	169	M47334	168
M44242	152	M46520	174	M46970	169	M47335	168
M44260	74	M46521	174	M46971	169	M47337	168
M44261	74	M46523	174	M46972	169	M47338	168
M44266	73	M46533	174	M46977	169	M47339	168
M44267	73	M46534	174	M46978	169	M47340	168
M44286	74	M46539	174	M46979	169	M47347	168
M44298	74	M46540	174	M46985	169	M47348	168
M44300	74	M46542	174	M46986	169	M47349	168
M44303	73	M46543	174	M47003	169	M47350	168
M44378	162	M46576	174	M47005	169	M47353	168
M44380	162	M46658	174	M47010	169	M47354	168
M44386	162	M46662	174	M47012	169	M47355	168
M44388	162	M46709	172	M47017	169	M47368	168
M44390	162	M46711	172	M47019	169	M47369	168
M44394	162	M46712	172	M47020	169	M47370	168
M44398	162	M46713	172	M47021	169	M47374	168
M44399	162	M46715	172	M47031	169	M47375	168
M44526	164	M46717	172	M47033	169	M47376	168
M44531	165	M46718	172	M47034	169	M47377	168
M44567	165	M46720	172	M47035	169	M47378	168
M44572	165	M46732	172	M47038	169	M47379	168
M44604	165	M46733	172	M47040	169	M47380	168
M44607	165	M46734	172	M47041	169	M47381	168
M44611	165	M46736	172	M47042	169	M47382	168
M44619	165	M46851	172	M47045	169	M47386	168
M44623	165	M46852	172	M47047	169	M47387	168
M44626	165	M46853	172	M47048	169	M47388	168
M44632	165	M46854	172	M47049	169	M47390	168
M44641	165	M46855	172	M47059	169	M47391	168
M44646	165	M46920	169	M47061	169	M47508	168
M44707	164	M46922	169	M47062	169	M47509	168
M44714	164	M46927	169	M47063	169	M47524	168
M44716	164	M46929	169	M47068	169	M47525	168
M44738	164	M46936	169	M47069	169	M47526	168
M44742	164	M46937	169	M47070	169	M47527	168
M44746	164	M46940	169	M47076	169	M47529	168
M44753	164	M46942	169	M47077	169	M47539	168
M44757	164	M46943	169	M47302	170	M47545	168
M44761	164	M46944	169	M47317	168	M47546	168
M44801	163	M46947	169	M47318	168	M47547	168
M44806	163	M46949	169	M47319	168	M47548	168



INDEX - ITEM NUMBER

Item #	Page #	Item #	Page #	Item #	Page #	Item #	Page #
M47550	168	M47709	169	M47941	170	M48098	170
M47565	168	M47710	169	M47942	170	M48099	170
M47566	168	M47711	169	M47943	170	M48100	170
M47567	168	M47712	169	M47944	170	M48102	170
M47568	168	M47715	169	M47945	170	M48115	170
M47570	168	M47716	169	M47949	170	M48116	170
M47576	168	M47737	170	M47950	170	M48117	170
M47577	168	M47738	170	M47951	170	M48119	170
M47578	168	M47739	170	M47952	170	M48133	170
M47579	168	M47745	170	M47954	170	M48134	170
M47581	168	M47746	170	M47955	170	M48135	170
M47587	168	M47747	170	M47956	170	M48137	170
M47588	168	M47749	170	M47959	170	M48153	170
M47589	168	M47753	170	M47960	170	M48155	170
M47590	168	M47754	170	M47961	170	M48171	170
M47592	168	M47761	170	M47962	170	M48173	170
M47596	168	M47762	170	M47965	170	M48902	171
M47597	168	M47763	170	M47966	170	M48903	171
M47598	168	M47765	170	M47967	170	M48904	171
M47599	168	M47777	170	M47971	170	M48905	171
M47600	168	M47778	170	M47972	170	M48907	171
M47605	168	M47779	170	M47973	170	M48915	171
M47606	168	M47781	170	M47974	170	M48917	171
M47607	168	M47793	170	M47984	170	M48918	171
M47608	168	M47794	170	M47985	170	M48919	171
M47610	168	M47795	170	M47995	170	M48920	171
M47676	169	M47797	170	M47996	170	M48925	171
M47677	169	M47809	170	M48017	170	M48926	171
M47678	169	M47810	170	M48018	170	M48931	171
M47679	169	M47811	170	M48023	170	M48932	171
M47680	169	M47813	170	M48024	170	M48933	171
M47681	169	M47825	170	M48025	170	M48934	171
M47682	169	M47826	170	M48031	170	M48937	171
M47683	169	M47827	170	M48032	170	M48946	171
M47686	169	M47829	170	M48033	170	M48948	171
M47687	169	M47841	170	M48035	170	M48949	171
M47688	169	M47842	170	M48045	170	M48950	171
M47689	169	M47843	170	M48046	170	M48952	171
M47694	169	M47845	170	M48047	170	M49303	173
M47695	169	M47859	170	M48049	170	M49304	173
M47697	169	M47861	170	M48062	170	M49306	173
M47698	169	M47875	170	M48063	170	M49307	173
M47701	169	M47877	170	M48064	170	M49309	173
M47702	169	M47936	170	M48066	170	M49310	173
M47703	169	M47937	170	M48080	170	M49362	173
M47704	169	M47938	170	M48081	170	M49363	173
M47705	169	M47939	170	M48082	170	M49364	173
M47706	169	M47940	170	M48084	170	M49675	173



INDEX - ITEM NUMBER

Item #	Page #	Item #	Page #	Item #	Page #	Item #	Page #
M49676	173	M55266	177	M55701	197	M60723	198
M49677	173	M55270	179	M55710	84	M60725	198
M49679	173	M55281	177	M55711	84	M60732	211
M49680	173	M55303	179	M55712	84	M60733	211
M49683	173	M55314	179	M55713	84	M60734	211
M49684	173	M55315	179	M55714	84	M60753	200
M49678	173	M55333	178	M55731	74	M60804	197
M49706	173	M55336	178	M55781	183	M60807	197
M49707	173	M55339	178	M55783	183	M60828	197
M49708	173	M55345	178	M55787	183	M60834	197
M49709	173	M55351	178	M55802	188	M60840	197
M49710	173	M55363	178	M55805	188	M60843	197
M49711	173	M55386	179	M55809	188	M60855	197
M49712	173	M55392	177	M55821	188	M60878	197
M49713	173	M55424	180	M55822	188	M60880	197
M49723	173	M55428	180	M55851	188	M60904	197
M49725	173	M55429	180	M55902	188	M60908	197
M49731	173	M55436	180	M55912	188	M60912	197
M49732	173	M55448	180	M55921	188	M60916	197
M49733	173	M55452	180	M60005	199	M60936	197
M49734	173	M55458	181	M60010	199	M60940	197
M50008	184	M55506	181	M60020	199	M60944	197
M50014	184	M55508	181	M60030	199	M60952	197
M50045	184	M55563	182	M60040	199	M60956	197
M50049	184	M55584	182	M60050	199	M60960	197
M50209	184	M55586	182	M60055	199	M60964	197
M20213	184	M55594	182	M60060	199	M61014	196
M50256	187	M55603	182	M60105	198	M61015	196
M50259	187	M55619	182	M60110	198	M61019	196
M50271	187	M55625	179	M60115	198	M61021	196
M50312	185	M55631	181	M60120	198	M61028	196
M50320	185	M55632	181	M60125	198	M61031	197
M50328	185	M55648	181	M60135	198	M61032	197
M50332	185	M55654	183	M60145	199	M61040	195
M50336	185	M55655	183	M60155	198	M61045	195
M50346	186	M55656	183	M60165	198	M61066	195
M50347	186	M55657	183	M60177	199	M61078	195
M50348	186	M55658	183	M60185	199	M61081	195
M50350	186	M55662	83	M60190	199	M61084	195
M50351	186	M55664	83	M60195	199	M61087	195
M50363	186	M55666	83	M60250	199	M61090	195
M50369	186	M55668	83	M60255	199	M61098	195
M50381	186	M55670	83	M60560	199	M61100	195
M50390	186	M55673	82	M60565	199	M61114	195
M50411	186	M55674	82	M60596	196	M61124	195
M55251	177	M55677	83	M60607	200	M61158	196
M55253	177	M55683	82	M60711	199	M61161	196
M55255	177	M55688	183	M60721	198	M61164	196



INDEX - ITEM NUMBER

Item #	Page #	Item #	Page #	Item #	Page #	Item #	Page #
M61171	196	M61618	193	M63304	220	M63635	217
M61179	194	M61625	191	M63331	221	M63637	217
M61183	194	M61637	192	M63333	221	M63641	218
M61189	194	M61649	193	M63337	221	M63643	218
M61193	194	M61655	192	M63339	221	M63645	218
M61202	194	M61660	193	M63343	221	M63655	218
M61204	194	M61675	192	M63349	221	M63659	218
M61210	194	M61681	193	M63367	212	M63703	221
M61212	194	M61696	194	M63377	222	M63706	221
M61214	194	M61708	194	M63379	222	M63722	221
M61216	194	M61716	195	M63381	222	M63725	221
M61218	194	M61724	195	M63383	222	M64013	212
M61220	194	M61730	195	M63385	222	M64015	212
M61222	194	M61736	195	M63389	222	M64020	212
M61229	193	M63008	221	M63396	222	M64025	212
M61233	193	M63009	221	M63397	222	M64033	212
M61234	193	M63014	219	M63401	217	M64056	214
M61241	194	M63020	219	M63402	217	M64064	214
M61244	194	M63030	219	M63404	217	M64070	214
M61278	191	M63042	219	M63406	217	M64074	214
M61283	192	M63048	219	M63408	217	M64076	214
M61284	191	M63054	219	M63409	217	M65015	184
M61290	192	M63066	219	M63411	217	M65029	201
M61293	191	M63072	219	M63412	217	M65043	201
M61296	191	M63084	219	M63413	217	M65056	204
M61299	192	M63102	219	M63425	217	M65083	204
M61305	191	M63108	219	M63427	217	M65104	204
M61311	192	M63114	219	M63429	217	M65115	212
M61314	191	M63120	219	M63431	217	M65119	205
M61315	191	M63126	219	M63443	217	M65122	205
M61320	191	M63206	219	M63501	218	M65131	206
M61354	192	M63218	219	M63505	218	M65167	205
M61358	192	M63227	219	M63509	218	M65179	202
M61362	192,194	M63251	219	M63512	217	M65180	202
M61366	191,192	M63256	219	M63514	217	M65186	202
M61375	192	M63262	219	M63516	217	M65187	202
M61399	192	M63281	219	M63518	217	M65188	206
M61402	192	M63283	219	M63553	217	M65190	206
M61431	191	M63284	219	M63556	217	M65216	203
M61437	191	M63287	220	M63559	217	M65220	205
M61443	191	M63288	220	M63566	217	M65231	202
M61447	191	M63289	220	M63568	217	M65249	206
M61448	191	M63290	220	M63574	217	M65254	206
M61449	191	M63292	220	M63575	217	M65269	204
M61554	193	M63293	220	M63576	217	M65275	203
M61575	194	M63294	220	M63613	218	M65277	204
M61592	192	M63297	220	M63614	218	M65278	204
M61614	193	M63299	220	M63628	217	M65279	204



INDEX - ITEM NUMBER

Item #	Page #	Item #	Page #	Item #	Page #	Item #	Page #
M65296	206	M65911	213	M70007	225	M70263	226
M65331	205	M65923	213	M70027	225	M70264	226
M65333	205	M65934	213	M70040	225	M70265	226
M65339	205	M66004	202	M70041	225	M70266	226
M65421	204	M66012	202	M70051	225	M70267	226
M65425	204	M66028	201	M70052	225	M70268	226
M65435	203	M66036	205	M70056	225	M70269	226
M65473	206	M66038	201	M70057	225	M70270	226
M65476	206	M66041	201	M70078	225	M70271	226
M65496	212	M66047	201	M70079	225	M70273	226
M65499	212	M66052	206	M70086	225	M70275	226
M65502	203	M66056	206	M70092	225	M70276	226
M65508	203	M66069	206	M70101	225	M70277	226
M65512	203	M66080	304	M70111	225	M70278	226
M65513	203	M66081	304	M70112	225	M70279	226
M65514	203	M66083	304	M70122	226	M70280	226
M65515	203	M66094	204	M70134	227	M70281	226
M65522	203	M66099	204	M70136	227	M70282	226
M65562	203	M66104	207	M70138	227	M70283	226
M65583	208	M66114	207	M70140	227	M70284	226
M65591	208	M66122	207	M70142	227	M70286	226
M65595	208	M66132	207	M70144	227	M70287	226
M65599	208	M66135	207	M70146	227	M70288	226
M65603	208	M66142	207	M70148	227	M70289	226
M65618	207	M66144	203	M70161	227	M70290	226
M65625	207	M66163	204	M70165	227	M70291	226
M65656	208	M66166	211	M70172	227	M70292	226
M65662	208	M66169	211	M70177	227	M70293	226
M65668	208	M66173	205	M70184	227	M70294	226
M65678	208	M66205	211	M70192	227	M70295	226
M65703	211	M66210	211	M70198	227	M70297	226
M65705	211	M66222	211	M70202	227	M70298	226
M65709	211	M66256	207	M70204	227	M70299	226
M65711	211	M66276	208	M70206	227	M70300	226
M65720	211	M69504	201	M70210	227	M70301	226
M65730	187	M69508	201	M70212	227	M70302	226
M65735	187	M69531	201	M70214	227	M70303	226
M65740	187	M69555	201	M70216	227	M70304	226
M65821	212	M69559	201	M70252	226	M70305	226
M65825	212	M69562	201	M70253	226	M70306	226
M65830	212	M69707	200	M70254	226	M70308	226
M65836	212	M69715	200	M70255	226	M70309	226
M65839	212	M69718	200	M70256	226	M70310	226
M65860	212	M69742	200	M70257	226	M70311	226
M65862	212	M69772	200	M70258	226	M70312	226
M65870	214	M69779	200	M70259	226	M70313	226
M65871	214	M69782	200	M70260	226	M70314	226
M65872	214	M69786	200	M70261	226	M70315	226



INDEX - ITEM NUMBER

Item #	Page #	Item #	Page #	Item #	Page #	Item #	Page #
M70316	226	M71255	229	M77012	41	M78103	230
M70317	226	M71266	229	M77015	41	M78113	230
M70319	226	M71269	229	M77018	41	M78115	230
M70320	226	M71282	229	M77034	41	M78117	230
M70321	226	M71289	229	M77035	41	M78168	230
M70322	226	M71320	227	M77040	41	M78182	230
M70323	226	M71325	227	M77041	41	M78196	230
M70324	226	M71340	227	M77049	41	M78210	230
M70325	226	M71350	227	M77054	42	M78224	230
M70326	226	M71390	227	M77058	42	M78238	230
M70327	226	M71410	227	M77062	42	M78252	230
M70328	226	M71415	227	M77121	42	M78266	230
M70329	226	M71430	227	M77776	24	M78280	230
M70331	226	M71490	227	M77777	24	M78294	230
M70339	226	M71510	227	M77819	230	M78308	230
M70445	226	M71515	227	M77833	230	M78322	230
M70461	228	M71550	227	M77847	230	M78331	230
M70512	228	M71595	227	M77849	230	M78350	230
M70514	228	M71605	227	M77851	230	M78364	230
M70518	228	M71615	227	M77861	230	M78378	230
M70524	228	M71650	227	M77863	230	M78392	230
M70530	228	M71660	227	M77875	230	M78406	230
M70536	228	M71690	227	M77879	230	M78420	230
M70542	228	M71781	227	M77889	230	M78434	230
M70554	228	M71791	227	M77891	230	M78448	230
M70889	228	M76007	277	M77903	230	M78462	230
M70894	228	M76013	277	M77905	230	M78476	230
M70895	228	M76019	277	M77907	230	M78490	230
M70896	228	M76025	277	M77917	230	M78504	230
M70898	228	M76048	277	M77931	230	M78518	230
M70907	246	M76052	277	M77959	230	M78532	230
M71007	228	M76057	277	M77973	230	M78546	230
M71012	228	M76276	277	M77975	230	M78560	230
M71017	228	M76280	277	M77987	230	M78574	230
M71027	228	M76289	277	M78001	230	M78588	230
M71037	228	M76302	277	M78015	230	M78602	230
M71042	228	M76315	277	M78029	230	M78616	230
M71104	228	M76402	277	M78043	230	M78630	230
M71108	228	M76404	277	M78045	230	M78658	230
M71156	228	M76501	277	M78047	230	M78672	230
M71204	229	M76603	113	M78071	230	M78686	230
M71207	229	M76609	113	M78085	230	M78700	230
M71210	229	M76621	113	M78087	230	M79601	230
M71214	229	M76625	113	M78089	230	M79701	230
M71228	229	M76628	113	M78091	230	M79851	230
M71231	229	M76630	113	M78093	230	M79951	230
M71240	229	M76633	113	M78099	230	M80004	254
M71243	229	M76636	113	M78101	230	M80007	254



INDEX - ITEM NUMBER

Item #	Page #	Item #	Page #	Item #	Page #	Item #	Page #
M80010	254	M81542	247	M82275	249	M84016	145
M80013	254	M81546	247	M82410	253	M84017	145
M80016	254	M81551	248	M82426	253	M84018	145
M80019	254	M81554	247	M82438	253	M84019	145
M80021	254	M81559	247	M82478	257	M84020	145
M80024	254	M81563	248	M82481	257	M84021	145
M80030	254	M81564	249	M82484	256	M84024	145
M80043	252	M81571	247	M82487	249	M84915	228
M80045	252	M81576	248	M82491	255	M85007	240
M80046	252	M81579	249	M82493	256	M85010	240
M80047	252	M81589	249	M82496	257	M85013	240
M80049	252	M81594	249	M82499	253	M85016	240
M80052	254	M81744	249	M82502	256	M85018	240
M80064	254	M82005	251	M82505	257	M85028	240
M80068	254	M82016	252	M82508	257	M85043	245
M80072	254	M82029	248	M82511	256	M85203	243
M80075	254	M82035	253	M82512	256	M85206	243
M80076	254	M82049	252	M82517	256	M85209	243
M80098	252	M82055	252	M82520	257	M82512	243
M80099	252	M82056	252	M82523	256	M85215	243
M81003	245	M82079	245	M82526	256	M85218	243
M81006	245	M82082	245	M82530	256	M85221	243
M81009	245	M82086	245	M82532	256	M85224	243
M81012	245	M82094	253	M82604	257	M85227	243
M81015	245	M82099	253	M82606	257	M85229	242
M81018	245	M82106	252	M82607	257	M85230	242
M81108	258	M82108	252	M82609	256	M85239	242
M81109	258	M82134	255	M82610	256	M85242	241
M81118	258	M82136	255	M82612	257	M85245	241
M81127	258	M82141	255	M82614	257	M85275	242
M81212	250	M82144	255	M82616	256	M85279	242
M81224	250	M82149	255	M82620	257	M85284	242
M81235	252	M82152	251	M82622	256	M85292	242
M81304	250	M82162	251	M82624	256	M85296	242
M81306	250	M82166	251	M82632	257	M85298	242
M81309	250	M82169	251	M82636	256	M85302	242
M81310	250	M82174	255	M82640	256	M85308	241
M81312	250	M82177	255	M82644	257	M85329	244
M81348	250	M82182	255	M82648	256	M85333	244
M81375	258	M82184	251	M82652	256	M85336	244
M81395	250	M82187	251	M82801	257	M85511	242
M81504	248	M82192	255	M82804	256	M85517	243
M81508	248	M82231	255	M82819	256	M85523	242
M81519	249	M82233	255	M82822	257	M85526	242
M81520	247	M82242	252	M82825	256	M85530	242
M81524	247	M82249	251	M82830	256	M85561	242
M81530	247	M82269	258	M82831	256	M85564	243
M81534	247	M82270	258	M84015	144	M85567	243



INDEX - ITEM NUMBER

Item #	Page #	Item #	Page #	Item #	Page #	Item #	Page #
M85580	242	M88090	235	M89023	246	M90503	281
M85592	242	M88099	235	M89026	246	M90506	280
M86001	258	M88117	236	M90003	297	M90509	280
M86002	258	M88126	236	M90009	297	M90512	263
M86003	258	M88135	235	M90012	297	M90515	280
M86015	258	M88114	235	M90015	297	M90518	280
M86016	258	M88153	233	M90024	297	M90527	281
M86017	258	M88171	233	M90027	297	M90530	280
M86018	258	M88180	233	M90030	297	M90533	280
M86019	258	M88189	234	M90036	297	M90536	281
M86020	258	M88207	235	M90042	297	M90539	281
M86101	258	M88216	235	M90054	297	M90553	290
M86102	258	M88225	235	M90057	297	M90556	290
M86103	258	M88234	235	M90166	297	M90558	290
M86115	258	M88243	252	M90169	297	M90559	290
M86116	258	M88270	235	M90178	276	M90561	290
M86117	258	M88279	233	M90184	276	M90562	290
M86118	258	M88288	233	M90203	276	M90565	290
M86119	258	M88297	233	M90226	276	M90568	290
M86120	258	M88315	235	M90231	276	M90571	290
M87022	233	M88324	235	M90232	276	M90577	290
M87063	238	M88333	233	M90236	276	M90578	290
M87076	237	M88342	235	M90245	276	M90583	286,290
M87089	238	M88351	235	M90251	277	M90586	288,290
M87115	237	M88360	233	M90253	276	M90589	286,290
M87128	238	M88369	233	M90256	277	M90592	286,288,289,290
M87141	238	M88378	233	M90272	277	M90595	290
M87167	237	M88387	233	M90274	277	M90601	288,289,290
M87180	237	M88396	233	M90282	278	M90604	290
M87193	238	M88405	233	M90285	278	M90607	290
M87206	237	M88414	233	M90288	278	M90611	294
M87219	238	M88432	235	M90290	278	M90615	267
M87232	237	M88450	234	M90292	278	M90616	267
M87245	237	M88459	234	M90294	278	M90639	284
M87258	237	M88477	234	M90298	278	M90648	290
M87271	238	M88486	234	M90301	278	M90656	283,287
M87297	238	M88495	233	M90304	278	M90659	283
M87310	237	M88522	233	M90353	279	M90665	283,287
M87323	237	M88531	235	M90365	279	M90668	283
M87336	238	M88558	239	M90368	279	M90671	283
M88018	233	M88630	239	M90371	279	M90674	283
M88027	233	M88762	239	M90380	279	M90680	283
M88036	233	M88769	239	M90383	279	M90683	283
M88045	234	M88788	239	M90403	280	M90685	283
M88054	236	M88807	239	M90406	280	M90801	284,287
M88063	236	M89016	246	M90409	280	M90802	284,287
M88072	235	M89018	246	M90412	280	M90804	285
M88081	235	M89020	246	M90415	280	M90805	285



INDEX - ITEM NUMBER

Item #	Page #	Item #	Page #	Item #	Page #	Item #	Page #
M90806	285	M91068	266	M92042	292	M92484	297
M90807	285	M91069	266	M92045	292	M92487	297
M90810	284	M91086	286	M92049	295	M92496	297
M90811	284,287	M91089	268	M92052	295	M92502	265
M90812	284,287	M91092	268	M92076	291	M92503	265
M90815	284	M91200	268	M92091	296	M92505	265
M90816	285	M91203	268	M92094	296	M92515	265
M90817	284	M91210	282	M92097	296	M92516	265
M90819	285	M91211	268	M92100	296	M92526	261
M90822	284	M91212	267	M92103	296	M92529	261
M90830	284	M91213	264	M92106	296	M92533	261
M91002	286	M91214	267	M92109	296	M92537	261
M91003	286	M91217	264	M92110	296	M92544	261
M91004	286	M91220	264	M92151	291	M92548	261
M91005	286	M91223	267	M92154	291	M92552	261
M91006	286,289	M91226	267	M92159	291	M92554	261
M91007	287	M91232	267	M92166	275	M92559	261
M91008	287	M91251	267	M92168	291	M92570	310
M91009	287	M91255	267	M92173	291	M92571	310
M91010	287	M91266	270	M92183	291	M92576	310
M91011	286	M91275	270	M92186	291	M92579	310
M91012	286	M91276	270	M92188	291	M92587	262
M91014	288	M91278	269	M92201	291	M92588	262
M91017	289	M91279	270	M92204	291	M92589	262
M91019	288	M91286	266	M92228	291	M92590	262
M91020	288	M91288	266	M92238	293	M92592	262
M91021	288	M91294	281	M92240	293	M92594	262
M91023	288	M91296	281	M92249	292	M92609	264
M91024	288,289	M91298	273	M92253	292	M92611	262
M91025	289	M91300	282	M92256	292	M92613	262
M91027	289	M91301	282	M92261	293	M92616	262
M91029	289	M91303	282	M92268	294	M92619	262
M91031	289	M91304	282	M92269	294	M92620	262
M91033	286	M91305	282	M92270	294	M92626	263
M91034	286	M91307	282	M92276	293	M92627	263
M91035	286	M91309	282	M92286	293	M92629	263
M91036	286	M91311	282	M92296	294	M92631	263
M91037	286	M91953	270	M92299	294	M92632	263
M91040	288	M91964	270	M92303	293	M92633	263
M91041	288	M92002	298	M92309	293	M92636	263
M91042	288	M92021	293	M92311	293	M92656	263
M91043	287,290	M92025	295	M92319	293	M92657	263
M91045	290	M92026	295	M92324	294	M92675	264
M91046	290	M92027	295	M92334	294	M92676	264
M91058	266	M92029	295	M92339	291	M92677	264
M91060	266	M92032	295	M92343	291	M92701	264
M91062	266	M92033	295	M92347	291	M92705	264
M91064	266	M92036	292	M92351	291	M92751	263
M91066	266	M92039	292	M92481	297	M92804	302



INDEX - ITEM NUMBER

Item #	Page #	Item #	Page #	Item #	Page #	Item #	Page #
M92809	302	M93690	306	M95432	310	M95762	272
M92812	302	M93691	306	M95434	310	M95763	272
M92815	302	M93692	306	M95435	310	M95764	272
M92818	302	M93694	269	M95439	310	M95765	272
M92819	302	M93695	269	M95440	310	M95766	272
M93406	305	M93697	307	M95448	310	M95767	272
M93412	305	M93698	307	M95449	310	M95780	272
M93418	305	M93699	307	M95453	310	M95782	272
M93424	305	M93700	307	M95454	310	M95783	272
M93453	275	M93701	307	M95470	310	M95785	272
M93456	275	M93702	307	M95471	310	M95786	272
M93459	275	M93711	307	M95516	272	M95787	272
M93462	275	M93712	307	M95524	272	M95788	272
M93465	275	M93721	308	M95532	272	M95799	272
M93471	275	M93722	308	M95540	272	M95800	272
M93474	306	M93723	308	M95541	272	M95804	272
M93652	306	M93724	308	M95556	272	M95812	272
M93653	306	M93732	308	M95564	272	M95820	272
M93654	306	M93733	308	M95580	272	M95828	272
M93655	306	M93751	308	M95588	272	M95901	309
M93656	306	M93754	308	M95592	272	M95902	309
M93657	306	M93760	308	M95604	272	M95903	309
M93659	306	M93765	308	M95620	272	M95904	309
M93660	306	M93766	308	M95628	272	M95905	309
M93661	306	M93770	308	M95636	272	M95906	309
M93662	306	M93771	308	M95644	272	M95907	309
M93663	306	M93776	308	M95652	272	M95908	309
M93664	306	M95392	310	M95653	272	M95909	309
M93666	306	M95393	310	M95660	272	M95910	309
M93667	306	M95394	310	M95668	272	M95911	309
M93668	306	M95395	310	M95676	272	M95912	309
M93669	306	M95396	310	M95683	272	M95913	309
M93670	306	M95397	310	M95684	272	M95914	309
M93671	306	M95398	310	M95686	272	M95916	309
M93673	306	M95399	310	M95687	272	M95917	309
M93674	306	M95400	310	M95691	272	M95918	309
M93675	306	M95402	310	M95692	272	M95919	309
M93676	306	M95406	310	M95700	272	M95920	309
M93677	306	M95410	310	M95708	272	M95921	309
M93678	306	M95411	310	M95745	272	M95931	309
M93680	306	M95412	310	M95746	272	M95932	309
M93681	306	M95413	310	M95747	272	M95934	309
M93682	306	M95414	310	M95748	272	M95935	309
M93683	306	M95415	310	M95756	272	M95936	309
M93684	306	M95417	310	M95757	272	M95937	309
M93685	306	M95421	310	M95758	272	M95938	309
M93687	306	M95428	310	M95759	272	M95939	309
M93688	306	M95429	310	M95760	272	M95940	309
M93689	306	M95431	310	M95761	272	M95941	309



INDEX - ITEM NUMBER

Item #	Page #	Item #	Page #	Item #	Page #	Item #	Page #
M95942	309	M97027	273	M97527	269	M99305	271
M95944	309	M97030	273	M97552	301	M99317	271
M95945	309	M97033	273	M97554	301	M99318	271
M95946	309	M97035	273	M97578	301	M99505	305
M95947	309	M97036	273	M97605	265	M99506	305
M95948	309	M97049	274	M97615	265	M99522	305
M95949	309	M97050	274	M98909	305	M99523	305
M95950	309	M97060	273	M98913	305	M99524	305
M95952	309	M97063	273	M98915	305	M99544	305
M95954	309	M97067	274	M98921	305	M99545	305
M95955	309	M97069	274	M98923	305	M99556	305
M95956	309	M97075	273	M99006	302	M99557	305
M95957	309	M97078	273	M99008	301	M99558	305
M95958	309	M97081	273	M99009	301	M99661	305
M95960	309	M97084	273	M99010	302	M99671	305
M95961	309	M97087	274	M99011	269	M99672	305
M95963	309	M97090	274	M99012	269	M99676	305
M95964	309	M97092	274	M99015	301	M99677	305
M95973	309	M97093	274	M99016	301	M99720	281
M95974	309	M97094	274	M99019	302	M99721	281
M95975	309	M97095	274	M99022	302	M99756	281
M95976	309	M97096	274	M99025	301	M99764	272
M95977	309	M97099	274	M99026	302	M99768	305
M95978	309	M97102	269	M99031	301	M99772	305
M95979	309	M97106	273	M99035	302	M99902	226
M95981	309	M97108	273	M99057	301	M99903	226
M95982	309	M97111	274	M99103	306	M99906	281
M95984	309	M97120	274	M99105	306	M99907	281
M95985	309	M97129	274	M99107	306	M99911	271
M95986	309	M97132	274	M99109	306	M99914	271
M95987	309	M97153	273	M99111	306	M99921	271
M95988	309	M97155	275	M99115	306	M99923	271
M95989	309	M97157	275	M99140	305	M99924	271
M95990	309	M97159	275	M99155	305	M99925	271
M95995	309	M97162	275	M99157	305	M99928	271
M95996	305	M97164	275	M99179	305	M99933	271
M96012	305	M97174	275	M99180	305	M99936	271
M96024	265	M97176	275	M99203	271	M99952	304
M96510	265	M97178	275	M99205	271	M99954	304
M96520	270	M97180	275	M99216	271	M99958	304
M96553	270	M97183	275	M99218	271	M99964	304
M96559	270	M97353	275	M99231	272	M99968	304
M96562	270	M97355	275	M99253	271	M99971	304
M96922	270	M97356	275	M99255	271	M99972	304
M97003	272	M97404	266	M99273	271	M99988	304
M97006	273	M97412	266	M99275	271	M99991	303
M97009	273	M97502	269	M99292	271	M99996	304
M97015	273	M97503	269	M99297	271	M99998	304
M97021	273	M97524	268	M99303	271		





Index - Alphabetical

INDEX - ALPHABETICAL

Abrasives		Ballcock	Bits, Drill 45-54
Belts 20		Fluidmaster 292	Blacktop Mix 157
Discs 22		Repair Parts 292, 293	Blades
Drywall Sheets 20		Shank Washer 294	Breakaway 63
Rolls 20, 22		Balls, Flapper Tank 295	Carbide Tipped 59
Sheets 21		Balls, Tank 293	Carpet 63
Sponges 20		Bandages 39	Circular Saw 59, 60
Access Panel 163		Barrel Bolts 14	Coping Saw 62
Acetone Solvent 222		Barrier Fence 162	Fan 228
Adapter, Grounding Plug 252		Bars, Grab 98	Hacksaw, Economy 58
Adhesives		Base, Cove 163	Hacksaw, High Speed 58
Cove Base 153		Base, Vanity 277	Jig Saw 62
Floor 153		Basin Rosette 266	Razor 62
Panel 153		Basin Stoppers 282	Reciprocating Saw 61
Spray 153		Basket, Strainers 267	Rod 60
Spreader 75		Bath	Saber Saw 62
Aerators 266		Drain 263	Utility 62, 63
Afta 205		Drain Parts 263	Blanks, Key 136, 137
A/C Furnace Filters 227		End Splash 277	Bleach 203
Air Conditioner Seal 159		Plate Assemblies 262	Blinds, Mini 230
Air Deodorizer 203		Plates, Overflow 262	Blinds, Vertical 230
Air Deodorizer Dispenser 203		Robe Hooks 98	Block
Air Gap		Soap Dish 97, 165	Urinal 207
Cleaning Tool 270		Spouts 262	Wall 207
Disposal 270		Stoppers 263, 282	Bloodbourne Kit 39
Replacement Cap 270		Toilet Paper Holder 97, 165, 199	Board, Cutting 277
Air Returns 227		Toilet Paper Rollers 165	Boiler Drains 281
Ajax Cleanser 204		Towel	Bolts
Alcohol, Denatured 222		Bars 98, 165	Combinations, Closet 291
Ammonia 204		Rings 98	Cutter 67, 69
Anchors		Bath Acces., Chrome & Brass 97-100	Eye 14
Hollow Wall 173		Bath Accessories, Ceramic 165	Hex 170
Plastic 173		Bathroom	Tank 291
Toggle 173		Cosmetic Boxes 99	Toggle 173
Angle Broom 191		End Splash 277	Boots 37, 38
Ant Bait 188		Fan 228	Boraxo Hand Soap 211
Ant Killer 188		Medicine Cabinets 99	Boric Acid Powder 188
Antenna, Radio 5		Sinks 276	Bottles, Sprayer 208
Antifreeze 214		Vanities 277	Bowl
Appliance		Vanity Tops 277	Blocks 207
Bulb 233		Batteries	Brush 194
Hand Truck 3		Charger 5	Cleaners 207
Touch Up Paint 221		Flashlight 24	Wax Rings 291
Arm, Shower 261		Industrial 24	Bowl Cleaner 207
Augers		Lantern 24	Box Cutter 64
Hand 298		Radio 5	Boxes
Rigid 299, 300		Bells, Door 144, 145	Cosmetic 99
Aviation Snips 68		Bends, Wall 273	Electrical 247, 248
Awl, Scratch 86		Bevel "T" 81	Brace, Broom 192
		Bi-Fold	Brackets
		Doors 167	Hand Rail 141
		Pin Caps 107-109	Pivot & Jamb, Closet Door 108
		Pin Springs 107-109	Shelf 111
		Pins 107-109	Brass Fittings 272
		Bibb Screws 290	Brass Nipples 272
		Bibb, Washers 290	Brasso (polish) 213
		Bird Guard, Dryer 225	Brazing, Gas Kit 303

B

Bab-O Cleanser 206
Bags, Trash 197
Balances, Window 102
Ballpeen Hammers 82
Ballasts, Fluorescent 240



INDEX - ALPHABETICAL

Breakers, Circuit	258	Calcium Chloride	184	Tile	164, 165
Brick Rubbing	73	Camera, Polaroid	24	Tile Adhesive	154
Brick Trowel	74	Can, Safety	213	Tile Cutter	65
Brillo Soap Pads	207	Candle Covers	252	Tile Nipper	65
Broiler Pans	229	Canopy Handles	283	Chain	
Broom Handles	192	Canopy Knobs	252	Double Loop	13
Brooms	191, 192	Canopy Switches	251	Proofcoil	13
Brushes		Caps, Toilet Bolt	291	Chandeliers	241
Acid	302	Caps, Electrical	252	Chandelier Candle Covers	252
Bowl	194	Car		Channel Lock Pliers	89
Deck	192	Antifreeze	214	Charcoal Filter	228
Dust	193	Wash	214	Charger	
Fender	193	Jumper Cables	214	Battery	5
Masonry	193	Carpenter Square	80	Tray, Motorola	5
Paint	217	Carpet		Chimes, Door	144
Plumbing	302	Bars	163	Chin Strap	29
Roofing	192	Blades	63	Chisels	
Scrub	193	Cleaner	202, 203	Cold	84
Washing	192	Defoamer	202	Flooring	84
Wire	218	Deodorizer	202, 203	Wood	75, 83
Bucket and Wringer Combination	196	Knives	64	Circline Fluorescent Lamps	238
Buckets	196	Plastic Protector	162	Circuit	
Bulbs		Rug Shampoo	202	Analyzer	258
Appliance	233	Spot and Stain Remover	202	Breakers	258
Candelabra	233	Tape	18	Tester	258
Chandelier	233	Carriage Screws	170	Circular Saw	93
Flood	234	Cart Maid	196	Circular Saw Blades	59, 60
Fluorescent	237, 238	Carton Sealing Tape	18	Clamps	
Incandescent	233-236	Cartridge Puller, Moen	301	Cable	15
Showcase	236	Cartridges		Dryer	225
Sodium	239	Moen	284	Hose	17
Spot	234	Delta/ Fit-All	283, 287	Installation	97
Torpedo	233, 234	Cascade Detergent	207	Repair, Pipe	305
Bump Cap	29	Cast Elbows	274	Spring	90
Bungee Straps	13	Catches, Cabinet	114	Clamps, "C"	88
By-Pass Hangers	107	Caulk		Cleaner, Vacuum	200, 201
		Acrylic Latex	151	Cleaner, Wet/Dry Vacuum	201
		Alex Plus	151	Cleaners	
		Guns	72	409 Cleaner/Degreaser	204
		Kwik-Seal	151	Afta	205
		Paintable	151, 152	Ajax	204
		Polyseamseal	151	Ammonia	204
		Silicone	152	Bab-O	206
		Tub & Tile	151	Bleach	203
		White Lightning	151	Brasso	213
		Caution Tape	18	Brillo	207
		Ceiling Light Fixtures	240, 242	Bully	207
		Ceiling Plates	310	Cascade	207
		Cement		Comet Cleasner	206
		Anchoring, Por-Rok	156	Dirtex	205
		Contact	153	Easy-Off	205
		Hydraulic	156	Endust	208
		Pipe	304	Fantastik	204
		Roof	152, 157	Glade	203
		Center, Punch	84	Glass Plus	208
		Ceramic		Love My Carpet	202
		Bath Accessories	165	Lysol	203, 205, 206

C

C-Clamp	88
Cabinet	
Catches	114
Door Pulls	139
Drawer Hardware	114
Fire Extinguisher	41
Hinges	114
Key	138
Knobs	113
Medicine	99
Medicine Shelf	100
Medicine, Track	100
Towel	198
Cable	
Clamps	15
Ridgid	300
Wall Plate	253
Wire	250



INDEX - ALPHABETICAL

Mop & Glo	202	Concrete	Cutter Mattock	183
Murphy Oil Soap	205	Caulk	Cutters	
Noxon	213	Mix	Bolt	69
Old English	208	Protector	Ceramic Tile	65
Pine Oil	204	Resurfacers	Glass	65
Pine Sol	204	Sealant	Plastic	69
Pledge	208	Cone Cups	Plexiglass	65
Resolve	202	Connectors	PVC	69
Spray Nine	204	Dishwasher Disposal	Rigid	299
Spic & Span	205	Drain and Trap	Tubing	69
Stainless Steel	213	Gas Appliance	Wire	67
Tide	207	Ground Joint	Cutting Board	277
Tilex	206	Romex	Cylinders	
Ultra Top Job	205	Slip Joint	Kwikset Titan	129
Windex	208	Wire	Mortise	134
X-14	206	Construction Adhesive	Rim	134
Zud	206	Cont. Waste Parts		
Closers, Door	105, 139	Contact Cement		
Clevis		Coping Saw		
Grab Hook	15	Copper		
Slip Hook	15	Cleaning Tool		
Closet		Fittings		
Bolt Combinations	291	Tubing		
Door Bi-Fold	167	Cordless Drills		
Door Hardware	107-109	Cords		
Flush Valves	292, 293	Dryer		
Poles, Adj	113	Ends		
Risers	271	Extension		
Spuds	291	Range		
Supply	271	Corners		
Wax Rings	291	Irons		
Closet Door		Flat Irons		
Floor Guides	108	Cosmetic Bulb		
Guides and Rollers	108, 109	Cosmetic Boxes		
Pivot & Jamb Brackets	108	Cotton, Mop Heads		
Plunger Pins	109	Counter Protectors		
Pulls	113	Coupler, Hose		
Snugglers	109	Couplings		
Cloth, Drop	218	Copper		
Cloth, Plumbers	22	Flexible		
Clothesline, Retractable	97	Malleable		
Cloths		PVC		
Dusting	199	Transition		
Industrial Wiping	199	Cove Base		
Coast, Flapper	295	Adhesive		
Coating, Roof	157	Rolls & Strips		
Collar, Cool Cat	31	Covers		
Combination Square	80	Outlet Box		
Comet	206	Paint Roller		
Compact Fluorescent Lamps	238	Sink Hole		
Compass Saw	56	Crescent Wrench		
Compound		Crow Bar		
Joint	154	Crumb Cups, Sink		
Pipe Joint	304	Cultivator		
Sweeping	201	Cups, Cone		
Compression Fittings, Brass	272	Cups, Foam		
		Cut-Off Wheels		

D

Dap

Alex Plus Caulk	151
Contact Cement	153
Concrete Sealant	152
Kwik-Seal Caulk	151
Silicone	152
Tub and Tile Sealant	151

Deadbolt

Economy	118
Kwikset	124, 126
Schlage	133
Deadlatches	128
Decal, Sliding Door	104
Deck, Faucets	278-280
Deck Mops	195
Degreaser	212

Delta

Ball	283
Basin Stoppers	282
Cam & Packing Assembly	283
Diverter Assembly	283
Faucet Spouts / Fits Most	283
Faucet Washers	283
Faucets	279
Repair Kit	283
Seat & Spring Assembly	283
Stems / Fits Most	283, 287
Deodorizer, Carpet	202
Denatured Alcohol	222

Detectors

Smoke	42
Voltage	258
Detergents	207

Diffusers

Cracked Ice	163
Floor	227
Medicine Cabinet	246
Digger, Post Hole	179
Digging Bar	183



INDEX - ALPHABETICAL

Dimmer Switches	255	Kick Plate	140	Extension	50
Dirtex	205	Knobs	117-126, 130-133	Drills, Cordless	91
Disc, Seat	293	Knockers	143	Drills, Electric	92
Dish, Soap	97, 165	Latches, Patio	104	Drip Pan	229
Dishwasher		Letterslot	146	Driveway Crack Filler	152
Air Gaps	270	Locks, Patio	103, 104	Drop Cloths	218
Branch Tailpiece	274	Patio Screen	104	Drywall	
Connector	270	Pre-Hung	167	Sheets	20
Detergent	207	Protectors	142	Screws	169
Disposal Connector	270	Pulls	139	Dryer	
Drain Hose	270	Push/Pull Plates	140	Bird Guard	225
Disinfectant	203, 204	Roller Assemblies, Patio Screen ...	105	Clamps	225
Dispensers		Rollers, Patio	105	Cords	254
Air Freshener	203	Screen	104	Hood	225
Paper Towel	198	Shoe	160	Lint Trap	226
Roll Towel	198	Slabs	167	Receptacle	252
Soap	211	Stops	141	Vent	
Toilet Paper	199	Storm Door Hardware	105	Hood	225
Towel	198	Strikes	104, 105, 126	Hose	225
Disposal		Sweeps	160	Kit	225
Connector, Dishwasher	270	Threshold	160, 161	Lint Trap	226
Garbage	269	Weather Strip	159	Louvers	225
Garbage, Strainer	267	Wrap Around	138	Duct, Dryer	225
Repair Parts	268	Douglas Flush Valve	293	Duct Tape	17
Seal	269	Downspout		Ducted Range Hood	228
Splashguard	268	Adapters	158	Ductless Range Hood	228
Stopper	268	Elbows	158	Dummy Knobs	117-123, 130-132
Tools	269	Extension	158	Duplex Receptacles	255
Waste Arm	269	Drain		Dust	
Diverter Assembly	283	Adapter, Dishwasher	270	Masks	32
Diverters, Tub Spout	262	Assemblies	281	Mop Heads	196
Door		Augers, Hand	298	Pan Brush	193
Accordion	167	Bath	263	Pans	193, 194
Bells	144, 145	Boiler	281	Duster	
Bells Wire	145	Cleaner	304	Counter	193
Bi-Fold	167	Cleaning Equipment	299, 300	Feather	194
Bi-Fold Pins	109	Cleaning Machines	298		
Blanks	167	Covers	267		
Bottoms	160	Grids	264		
Bumpers	142	Hose, Dishwasher	270		
Catches	139	Openers	304		
Chain	144	Pipe Connector	274, 275, 307		
Chimes	144	Plungers	297		
Closers	105, 139	Protector	267		
Closet		Spade	179		
Floor Guides	108	Stoppers	263		
Plunger Brackets	108	Drain Opener (chemical)	304		
Plunger Pins	109	Drawer, Cabinet Hardware	113, 114		
Snugglers	109	Drill Bits			
Decal, Sliding Door	104	Fractional	45		
Guard, Chain	144	Letter	48		
Handles, Patio	104	Cobalt	51		
Hinges	140, 141	Sets	49		
Intercom	145	Number	46, 47		
Interior Wood	167	Machine	52		
Keepers, Patio	104	Masonry	53		
Key Plugs, Patio	104	Hammer	53		

E

Ear Plugs	31
Ear Protectors	31
Easy-Off	205
Edger, Lawn	182
Elbow	
Malleable	310
Repair Trap	273
Sink Trap	273
Slip Joint	274
Elbows	
Brass	272
Copper	309
PVC	306
Electrical	
Appliance Cords	254
Ballasts	240
Boxes	247, 248
Caps	252



INDEX - ALPHABETICAL

Circuit		Extension, Cords	254	Fire Extinguishers	41
Analyzer	258	Extension Couplings	274	First Aid Kits	39
Breakers	258	Extension Tubes	273, 274	Fit-All, Tank Lids	297
Tester	258	Extinguishers, Fire	41	Fitting Brushes	302
Dryer Cords	254	Eye		Fittings	
Extension Cords	254	Bolts	14	Brass	272
Fixtures	240-244	Screws	14	Copper	309
Flashlights	25	Hook & Eye	14	Malleable	310
Fluorescent Starters	245	EZ Anchors	173	PVC	306
Fuses	258	EZ Grabber	197	Five-In-One Screwdriver	86
Lamp Cord	254			Fixture Sockets	251
Lamp Holders	245			Fixtures	
Madison Hanger	249			Bathroom	243
Outlet Box Covers	249, 257	F		Ceiling	242
Outlets	252	Face Shield	30	Chandelier	241
Photo Controls	245	Facial Tissue	200	Fluorescent	240
Range Cords	254	Fan		Lighting	240, 251
Receptacle Covers	249	Bath	228	Outdoor	244
Receptacle Tap	252	Blades	228	Pendant	241
Receptacles	255	Exhaust	228	Porcelain	251
Romex Connector	250	Motors	228	Toilet Paper Holder	97, 165, 199
Smoke Detector	42	Fans, Exhaust	228	Flag, Safety	38
Sockets	251	Fantastik	204	Flagging Tape	18
Switches	255	Fast Plug	156	Flange, Spanner	291
Tape	18, 250	Faucet		Flanges	
Telephone Accessories	253	Aerator Adapters	266	Shower Arm	261
Terminals	250	Aerators	266	Shower Rod	265
Tester	258	Handle Puller	301	Flapper Tank Balls	295
Timers	253	Handles	283-285	Flashing, Aluminum	157
Trouble Light	254	Nuts	266	Flashlights	25
Wall Plates	256, 257	Repair Kits	283, 284	Flat Washers	171, 290
Wire		Replacement Handles	283-285	Flexible Tailpieces	307
Cable	250	Spouts	283	Flip-It Stopper	263
Connectors	250	Washer/Screw Assortment Kit	290	Float, Masonry	73
Nuts	250	Washers	290	Floating Lantern	25
Romex	250	Wrenches	301	Flood Lamps	234
Eljer		Faucets, Complete		Floor	
Ball Rod Assembly	293	Delta	279	Absorbent	201
Flush Valves	293	Economy	278	Adhesive	153, 154
Tank Ball	293	Moen	280	Care Products	202
Tank Levers	296	Sterling	280	Covering, Rosin Paper	163
Emery Cloth	21	Feather Duster	194	Diffusers	227
End Caps, Hose	186	Felt, Roof	157	Door Stops	141, 142
End Splash	277	Fence		Finish	202
Endust	208	Barrier	162	Grout	155
Entry Leversets	122, 123, 125, 133	Safety	162	Grout, Closet Door	108
Entry Locks	117, 119, 120-123, 125, 130	Silt	162	Guides, Closet Door	108
Entry Sets	126, 130, 133	Fender Brush	193	Mats	163
Epoxy, Enamel	219	Fender Washers	171	Mops	195, 196
Epoxy Putty	152	Fiberglass Joint Mesh Tape	19	Patch	156
		Files	73, 76	Plates	310
		Film, Polaroid	24	Protectors	162
		Filters		Sign	197
Eureka	200	Charcoal	228	Squeegee	194
Exhaust Fans	228	Fiberglass Mat	227	Stripper	202
Exit, Bulbs	236	Furnace	227	Tile	165, 166
Epoxy	153	Rangehood	228	Tile Cement	153
Expanding Foam	152	Fire Extinguisher, Cabinets	41	Floor and Ceiling Plates	310



INDEX - ALPHABETICAL

Hedge Shears	182	Incandescent Bulbs	233-236
Hex and Square End Seat Wrench	302	Insect Fogger	188
Hex		Insect Killer	188
Bolts	168, 170	Insert Bits	87
Head Screws	168, 170	Install-A-Lock	138
Key	88	Installation Clamp	97
Lag Screws	170	Installation Lock Jig	129
Nuts	172	Insulating Sealant	152
High Pressure Sodium Lamps	239	Interconnected Lock	133
Hoe, Garden	181	Interior Wood Doors	167
Hold-Zit Strap	13	Intermatic Photo Controls	245
Hole Cover Plate	267	Irrigation Hose	185
Hole Saw Pilot Drill	54	Ivory Soap	211
Hole Saws	55		
Hood			
Dryer	225		
Range	228		
Vent, Dryer	225		
Hooks & Eyes			
Grab	15		
“S”	14		
Slip	15		
Hornet Spray	188		
Hose			
Adapters	266		
Clamps	17		
Commercial	185		
Connector Kit	270		
Couplings	186		
Drain, Dishwasher	270		
End Cap	186		
Garden	185		
Irrigation	185		
Menders	186		
Nozzle	186		
Shut-Off	186		
Sink	266		
Sprinkler	187		
Vent, Dryer	225		
Washers	186		
Washing Machine	270		
“Y” Connector	186		
Hose and Spray Sets	266		
House Numbers	143		

I

Ice			
Melt, Chemical	184	Jeweler’s Screwdriver	86
Pick	86	Jiffy Plug	252
Scraper	214	Jig, Lock Installation	129
Trays	277	Jig Saw	94
Ice Choppers	177	Jig Saw Blades	62
Ice Cube Trays	277	Jimmy Proof Locks	134
Igloo Coolers	40	Joint Compound	154
Ilco Key Machines	135	Joint Tape	19
In-Sink-Erator Garbage Disposals	269	Jumper Cables	214

J

J-Bends	273
Janitor Cart	196
Janitorial	
Air Fresheners	203
Brillo Pads	207
Brooms	191, 192
Brushes	192-194
Buckets	196
Carpet Cleaners	202, 203
Carpet Deodorizer	202, 203
Cleaner Caddy	196
Deodorizers	203, 204
Dust Pans	193, 194
Hand Cleaners	199, 211
Mops	195, 196
Nifty Nabber	197
Paper Products	198, 199
Pest Control	188
Polish	208
Rags and Wiping Cloths	199
Shop Vac	201
Sponges	195
Sprayer Bottles	208
Squeegees	194
Trash Can Lids	197
Trash Cans	197
Trash Liners	197
Vacuum Cleaner	
Accessories	200, 201
Vacuum Cleaners	200, 201
Wet/Dry Vacuum Cleaners	201
Work Gloves	36

K

Keepers	
Patio Door	104
Patio Screen Door	104
Key	
Blanks	136, 137
Cabinets	138
Gauge	129
Hex	88
Machines	135
Plugs, Patio Door	104
Tags	138
Key Plugs, Patio Door	104
Keying Kits	135
Kick Plates	140
Kilz Primer Sealer	221
Kitchen	
Faucets	278-280
Sink Accessories	266-270
Sinks	276
Kits	
Anchor	173
Ballcock Repair	293
CRDL Drill	91
Delta Faucet Repair	283
Dryer Vent	225
First-Aid	39
Fluidmaster Repair	295
Icemaker	305
Keying	135
Lock Install	54, 129
Moen Faucet Repair	284
O-Ring	290
Propane Torch	303
Tank to Bowl Repair	291
Terminal	250
Kleenex	200
Knee Pads, Rubber	73
Knives	
Box Cutter	64
Carpet	63, 64
Industrial	64, 65
Linoleum	65
Putty	70
Taping	70
Utility	63
Knobs	
Cabinet	113
Door	117-125, 130-133
Oven	229
Knockers, Door	143
Kohler	
Pop-Up Stopper, Bath Drain	282
Stems	286
Krazy Glue	153



INDEX - ALPHABETICAL

Kwikset

Accessories	126, 128, 129
Handle Trim	125
Key Blanks	136
Key Kits	135
Locksets	119-129
Trim Plates	???
Krylon, Striping Paint	220

L

Lacquer Thinner	222
-----------------------	-----

Ladders

Aluminum	6
Extension	7
Fiberglass	7
Wood	6
Lag Screws	170
Lag Screw Shields	173

Lamp

Cord	254
Holders	249
Holders, Fluorescent	245

Lamps

Circline Fluorescents	238
Compact Fluorescent	238
Flood	234
Fluorescents	237, 238
Heat	236
High Pressure Sodium	239
Incandescent	233-236
PL Compact Fluorescent	238
Quartz Halogen	239
Reflector	234
Spot	234
T-8 Fluorescents	237
U-Bent Fluorescents	238

Lan-Lin Hand Cleaner	211
----------------------------	-----

Latches

Gate	14
Kwikset	128
Window	103
Latex Paint	221

Laundry

Detergent	207
Faucets	281
Tray Faucets	281
Laundry Tub	276
Lava Hand Soap	211

Lavatory

Faucets	278-280
Legs	276
Risers	271
Sink Accessories	277
Sinks	276
Vanities	277
Vanity Tops	277
Wall-Hung Sinks	276

Lawn Edger	182
Legs, Lavatory	276
Lens, Range Hood	228

Level

Line	80
Mason	80
Leveler Patch	156
Lever Handles	296
Levers, Tank	296
Lids, Tank	297
Light, Trouble	254

Lighting

Bulbs	233-235
Circline Fluorescent Lamps	238
Diffusers	246
Fixtures	240
Flood Lamps	234
Fluorescent Lamps	237, 238
Globe Light Bulbs	235
Heat Lamps	236
High Pressure Sodium Lamps	239
PL Compact Fluorescent Lamps	238
Quartz Halogen Lamps	239
Reflector Lamps	234
Replacement Glass	242-244
Replacement Globes	242-244
Round Bulbs	235
Spot Lamps	234
Strip Lights	243
T-8 Fluorescent Lamps	237
Torpedo Bulbs	233, 234
U-Bent Fluorescent Lamps	238
Line, Braided	74
Line Level	80
Liners, Hard Hat	29
Liners, Trash	197
Lines, Gas	226

Linesmans Pliers	67
Linkages, Bath Drain	264
Linoleum Knife	65
Lint Trap Kit	226
Lithium Grease	214

Liquid

Drain Opener	304
Nails	153
Wrench	212
Lobby Broom	191
Lobby Dust Pan	193, 194
Lock Washers	171

Locks

Cam	147, 148
Deadbolts	118, 124, 126, 133
Dummy	117, 123, 130, 131, 132
Entrance Sets	126, 130
Entry	117, 119-125, 130
Gate	14
Ilco	134

Installation Kit	54, 129
Jimmy Proof	134
Mailbox	147, 148
Passage	117-123, 125, 130-132
Patio Door	104
Privacy	117-123, 125, 130-132
Sash, Window	103
Loppers	182
Louvers Vent, Dryer	225

Lubricants

Liquid Wrench	212
Silicone Spray	212
WD-40	212
Lute Rake	74
Lysol Disinfectant	203, 205, 206

M

Machines

Drain Cleaning	298
Key	135
Magnesium Chloride	184
Maid Cart	196
Mail Slots	146
Mailbox Locks	147, 148
Mailboxes	146
Mailboxes, Gang	146
Mallet, Rubber	83
Mansfield, Tank Levers	296
Manure Fork	181
Marble Thresholds	160
Markers, Ink	221
Markers, Paint	221
Masking Tape	17
Masks, Dust	32
Mason Level	80

Masonry

Bit	53
Brush	193
Sealant	156
Master Padlocks	8, 9
Mats, Floor	163

Mattocks

Cutter	183
Pick	183
Measuring Tape	77, 78
Medicine Cabinet, Diffusers	246
Medicine Cabinets	99
Menders, Hose	186
Mending Plates	16
Metal Cleaner	199, 213
Mini-Blinds	230
Mini-Spray Maid	265
Mirror	101
Mirror & Glass Accessories	100
Mirror Pull	100



INDEX - ALPHABETICAL

Phillips	Plug, PO	273	Flush Valves	292, 293	
Drywall Screws	169	Plug Follower	129	Garbage Disposal Splash Guards ..	268
Self Drilling Screws	169	Plugs	Garbage Disposal Stoppers	268	
Slotted Combo Sheet		Key	Garbage Disposals	269	
Metal Screws	169	Malleable	Gate Valves	305	
Photo Controls	245	Plumbers	Hose	266, 270	
Pick Handle	183	Cloth	Kitchen Sinks	276	
Pick Mattock	183	Grease	Laundry Tub	276	
Pine Cleaner	203, 204	Putty	Lavatory Sinks	276	
Pine-Sol	204	Plumbing	Lift Rod Assemblies	264	
Pineapple Glass Fixture	242	Adapters, PVC	Malleable Fittings	310	
Pins		Aerator Adapters	Needle Valve	272	
Closet Door Plunger	109	Aerators	Needle Valve Kit	272	
Kwikset	135	Ball Rod	Nipples	310	
Pipe		Ballcocks	O-Rings	290	
Cement	304	Repair Kits	Overflow Plates	262	
Cleaner	304	Repair Parts	Pipe Repair Clamp	305	
Connector	274	Basin Rosette	Plastic Bolt Caps	291	
Cutting Tool	69	Basin Stoppers	Plates, Tub	262	
Joint Compound	304	Basket Strainers	Plungers	297	
Repair Clamps	305	Bath Drain Parts	PO Stoppers	282	
Wrenches	90	Bathroom	Pressure Pump	297	
Pivot & Jamb Bracket	108	Cosmetic Boxes	PVC Couplings	306, 307	
Pivot Pins	109	Medicine Cabinets	PVC Tubing	306	
PL Compact Fluorescent Lamps	238	Mirror	Reducing Coupling	309	
Plaster of Paris	155	Vanities	Relief Valves	281	
Plaster Patch	155	Vanity Tops	Risers	271	
Plaster Wall Patch	155	Bibb Screws	Rosettes	266	
Plastic		Bibb Seats	Shower		
Cutter	65	Bibb Washers	Arms	261	
Sheeting	162	Boiler Drain	Heads	261	
Wood	154	Brass Closet Spuds	Rod Flanges	265	
Plates		Cable	Rods	265	
Address	140	Closet Bolt Combinations	Strainers	264	
Floor & Ceiling	310	Compounds and Sealants	Sillcocks	281	
Hole Cover	267	Compression Fittings	Sink		
Overflow	262	Copper Preparation Products ..	Connection Washers	275	
Phone, Wall	253	Couplings	Strainers	267	
Push and Pull	140	Dishwasher Connector	Slip Joint Washers	275	
Splash	228	Disposal Repair Parts	Spanner Flange	291	
Trim, Kwikset	125	Disposal Strainer	Spud Washers	291	
Wall	256, 257	Diverter, Stem	Stems	286-289	
Plates, Kick	140	Diverter, Tub	Stop Valves	271	
Pledge	208	Drain Assembly	Stoppers	263, 282	
Pliers		Drain Hand Auger	Stoppers, Tub and Basin	263	
Channel Lock	89	Drain Cleaning Equipment	Sump Pumps	301	
Diagonal Cutting	66	Drainage Fittings	Supply Lines	271	
Floor & Ceiling	310	Elbows, PVC	Supply Tubes	271	
Lineman's	67	Faucet	Tailpieces	274	
Long Nose	67	Handles	Tank		
Multi, Snip	67	Nuts	Balls	293	
Slip Joint	89	Spouts	Bolts	291	
Wire Cutter	67	Washers	Levers	296	
Plug		Faucets	Lids	297	
Adapter	252	Flapper Tank Balls	Tank to Bowl Gaskets	291	
Female	252	Floor and Ceiling Plates	Tank to Bowl Repair Kits	291	
Male	252	Flush Valve Repair Parts	Tees, PVC	306	
Jiffy	252				



INDEX - ALPHABETICAL

Roof		Jig	94	Shims, Wood	163
Cement	152, 157	Pruning	57	Shop Vac	201
Coating	157	Reciprocating	93	Shovels	
Felt	157	Toolbox	56	Garden	178
Roofing, Brush	192	Schlage	130-133	Snow	177
Rope, Manila	13	Scissors	68	Shower	
Rosettes, Basin	266	Scoop	179	Door	115, 116
Rosin Paper	163	Scouring Pad	194	Drain Grid	264
Rotary Dimmer	255	Scraper, Razor	71, 72	Faucets	280, 281
Round Point Shovels	178	Scrapers		Heads	261
Rub Brick	73	Floor	66	Rod Flanges	265
Rubber Mallet	83	Ice	177	Rods	265
Rubber Tie Down Straps	13	Paint	70	Strainers	264
Rubbermaid		Wallpaper	71	Surround	265
Dust Pan	193	Wood	71	Shower Arm, Flanges	261
Mop Bucket	196	Screen		Shower Arms	261
Trash Container Dolly	197	Doors	103	Shut-Off Valves	271
Trash Containers	197	Frame	106	Sign, Bulbs	236
Rug Shampoo	202	Screen Door Hardware	105	Signs	
Rules, Measuring	79	Screwdriver		Caution Hard Hat	38
		Electric	92	No Trespassing	38
		Four-In-One	86	Post, 10'	38
		Jewelers	86	Restroom Closed	197
		T-Handle	86	Wet Floor	197
		Screwdrivers	85, 86	Silicone	
		Screws		Caulk	152
		Bibb, Bronze	290	Spray	212
		Drywall	169	Sillcock	281
		Hex Head	170	Silt Fence	162
		Hex Lag	170	Silver Solder	303
		Machine	168	Silver Solder Flux	304
		Overflow Plate	262	Sink	
		Self Drilling	168	Basin and Bath Gaskets	275
		Sheet Metal	169	Basket Strainer	267
		Scrub, Brush	193	Connection Washers	275
		Scrubs-In-A-Bucket	199	Crumb Cups	267
		Scrubs, Stainless Steel	199	Hole Covers	267
		Sealant		Hose & Spray Set	266
		Concrete and Masonry	156	Legs	276
		Insulating	152	Rims	277
		Roof and Flashing	157	Risers	271
		Window and Door	159	Stoppers	282
		Seat & Spring Assembly	293	Strainers	267
		Seat Disc	293	Supply Lines	271
		Seats, Toilet	297	Traps	273
		Seed, Grass	184	Sink, Trap Elbow	273
		Self Drilling Screws	168	Sinks, Lavatory	276
		Shackle, Anchor	15	Slamscrapper	66
		Shears		Sledge Hammer	83
		Electric	94	Sleeves, Compression	272
		Grass	182	Sleeves, Paint Roller	217
		Hand	68	Slip Couplings	274, 275, 307
		Hedge	182	Slip Elbows	274
		Pruning	182	Slip Joint	
		Sheet Metal Screws	169	Connectors	274, 307
		Shelf, Brackets	113	Nuts	275, 307
		Shields, Lag	173	Washers	275

S

"S"-Hooks	14				
Saddle Valve	272				
Safety					
Belts	31				
Bump Cap	29				
Ear Plugs	31				
Ear Protectors	31				
Gasoline Can	213				
Glasses	30				
Goggles	30				
Hasp	11, 12				
Knee Pads	73				
Rail	162				
Sand					
All Purpose	157				
Mix	156				
Play	157				
Sander, Electric	93				
Sanding					
Block/Sponge	20				
Disc	22				
Paper	21				
Sandpaper	21				
Sash Locks, Window	103				
Saw					
Bowsaw	57				
Circular	93				
Compass	56				
Coping	57				
Cordless	91				
Drywall	56				
Grout	75				
Hacksaw	57				
Hand	56				



INDEX - ALPHABETICAL

Smoke Alarms		Paint	219	Lift and Turn	263
Battery Operated	42	Silicone	212	Pop-Up	282
Fymetics	42	Sprayer		Tip-Toe	263
Tester	42	Bottles	208	Tub	264
Snaps		Tank	184	Stops	
Bolt	15	Spraymaids	265	Door	141, 142
Double Bolt	15	Spray Nine	204	Floor	142
Snips	67, 68	Spreaders	184	Gas	226
Snow Brush	214	Spring Clamps	90	Water	271
Snow Removal		Springs		Storm Door Hardware	105
Icemelt	184	Bi-Fold Pin	107	Strainer Wrench	301
Pushers	177	Kwikset	135	Strainers	
Scraper	177	Sprinkler Hose	185	Basket	267
Shovels	177	Sprinklers	187	Garbage Disposal	267
Spreaders	184	Spud Washers	291	Tub	264
Snugglers, Closet Door	109	Spud Wrench	302	Strainers, Sink	267
Soap		Spuds, Closet	291	Strapping Tape	18
Dish	97, 165	Square "D" Breaker	258	Street Broom	192
Dispensers	211	Square Point Shovels	178, 179	Strikes	
Hand	211	Squares		Adjustable	126
Pads	207	Bevel	81	Lockset	126
Socket Sets	89	Carpenter	80	Storm Door	105
Socket Wrenches	89	Combination	80	String, Pull Chain	252
Sockets, Light	251	Squeegee		Striping	
Soft Scrub	206	Floor	194	Machine	220
Sodium Bulbs	239	Window	194	Paint	220
Solder, Silver	304	Stainless Steel Cleaner	213	Wand	220
Solder, Wire	303	Standard, Tank Levers	296	Striplites	243
Spackling	155	Staple		Stripper, Floor	202
Spade		Gun	90	Stripper, Wire	67
Bits	50	Wire	248	Stop Valves	271
Cutter	299	Staples	90	Stove Knobs	229
Drain	179	Staples, Wire	248	Styrofoam Cups	200
Spanner Flange	291	Starters, Fluorescent	245	Sump Pumps, Utility	301
Spic and Span	205	Steel Wool	22	Supply Lines	
Splash Guards, Garbage Disposal	268	Stems		Icemaker	305
Splash Plate	228	American Standard	287	Sink	271
Splash Blocks	158	Delta	287	Tank	271
Spline, Screen	106	Gerber	286, 289	Supply Tubes	271
Spline Rollers	106	Kohler	286	Surface Savers	277
Sponge, Sanding	20	Price Pfister	286, 288, 289	Surform Files	73
Sponges		Sterling	288	Surrounds	
Commercial	195	Symmons	290	Shower	265
Mop	195	Union Brass	286	Tub	265
Sanding	20	Step Ladders		Sweat Band	29
Scouring	195	Aluminum	6	Sweeping Compound	201
Scrubbing	195	Fiberglass	7	Switches	
Spot Lamps	234	Wood	6	Canopy	251
Spouts		Sterling		Dimmer	255
Bath	262	Bath Drain Parts	263	Pull Chain	251
Diverter	262	Faucet	280	Three-Way	251
Tub	262	Pop-Up Stopper, Bath Drain	282	Toggle	251
Spray		Stems	288	Wall	255
Adhesive	153	Stoppers		Symmons, Cartridges	290
Enamel	219	Basin	268		
Epoxy	219	Flip-It	282		
Heads	261	Garbage Disposal	268		



INDEX - ALPHABETICAL

T

Tags, Key	138	Tile	Ceiling	163	Track	Door, Closer	108
Tailpieces		Cement, Floor	154	Ceramic	164	Medicine Cabinet	100
Dishwasher	274	Cutter	65, 66	Floor	165, 166	Shower Door	116
Dishwasher Branch	274	Grout	155	Grout Saw	75	Traffic Paint	220
Drain Pipe	308	Mosaic	165	Nipper	65	Transition Couplings	275
Flexible	307	No-Wax	166	Wall	164	Trap, Adapter	308
Slip Joint	307	Tilex	206	Timers		Traps	
Straight	273	Tripper	253	Twenty-Four Hour	253	Glue	188
Tampers	183	Tip-Toe Stopper	263	Tissue, Facial	200	Mouse	188
Tamping Bar	183	Tissue, Facial	200	Toggle Bolts	173	"P"	273
Tank		Toggle Switches	251, 255	Toilet		Quick	273
Balls	293	Augers	298	Ballcock Repair Parts	292	Rat	188
Bolt Caps	291	Ballcocks	292	Ballcocks	292	Sink	273
Bolts	291	Bowl Brush	194	Flapper Tank Balls	295	Trash	
Flapper Balls	295	Flapper Tank Balls	295	Flush Valve Repair Parts	293	Cans	197
Levers	296	Flush Valve Repair Parts	293	Flush Valves	292, 293	Container w/ Wheels	197
Parts, Toilet	291-296	Flush Valves	292, 293	Paper		Nifty Grabber	197
Sprayer	184	Paper		Dispenser	199	Trash Liners	197
Supply Lines	271	Dispenser	199	Holders	97, 165	Wastebaskets	197
Tank to Bowl Gaskets	291	Holders	97, 165	Rollers	165	Trays	
Tank to Bowl Repair Kits	291	Rollers	165	Tissue	199	Ice Cube	277
Tank, Sprayer	184	Tissue	199	Repair Parts	291-296	Liner, Paint	217
Tap, 3-Way	252	Repair Parts	291-296	Seat Disc	293	Paint	217
Tap, Receptacle	252	Seat Disc	293	Seats	297	Tree Trimmer	182
Tape		Seats	297	Tank		Trim Rings	229
Carpet	18	Tank		Balls	293	Trippers, Timers	253
Carton Sealing	18	Balls	293	Levers	296	Trouble Light	254
Caution	18	Levers	296	Lids	297	Trowel	
Duct	17	Lids	297	Parts	292-294	Brick	74
Electrical	18, 250	Parts	292-294	Supply Lines	271	Finishing	74
Flagging	18	Supply Lines	271	Tissue Holders	199	Garden	181
Fiberglass Joint	19	Tissue Holders	199	Tissue Roll Fixture	199	Notched	75
Foil	19	Tissue Roll Fixture	199	Toilets	297	Truck, Hand	3
Joint	19	Toilets	297	Toothbrush/Tumbler Holder	165	Truck, Appliance	3
Masking	17	Toothbrush/Tumbler Holder	165	Top, Vanity	277	Tub	
Measuring	77, 78	Top, Vanity	277	Top & Bond	156	Enclosures	265
Teflon	18	Top & Bond	156	Top Job	205	Laundry	276
Taping, Knives	70	Top Job	205	Torch, Propane Kit	303	Splash Enders	265
Tees		Torch, Propane Kit	303	Torpedo Bulbs	233, 234	Spouts	262
Compression	272	Torpedo Bulbs	233, 234	Torpedo Levels	80	Stoppers	263, 264
Copper Wrought	309	Torpedo Levels	80	Touch-Up Paint	221	Strainers	264
Malleable	310	Touch-Up Paint	221	Towel		Surrounds, Adhesive	265
PVC	306	Towel		Bars	98, 116, 165	Tip-Toe Stopper	263
Teflon Tape	18	Bars	98, 116, 165	Rings	98	Tub and Shower	
Telephone, Wall Jacks	253	Rings	98	Towels, Paper	198, 199	Door	115, 116
Terminal Kit	250	Towels, Paper	198, 199			Door Rollers	116
Tester						Valve	280
Circuit	258					Tub and Tile Caulk	151
Smoke Alarm	42					Tub Wall Kits	265
Thermocoupler	305					Tubes	
Thinner, Paint	222					Extension	273, 307
Three-Way Switches	251					Supply	271
Thresholds	160, 161					Threaded	273
Tide Detergent	207						



INDEX - ALPHABETICAL

Tubing
 Copper 305
 Cutters 69
 PVC 306
 Refrigeration Copper 305

Tubular
 Brass 273, 274
 Plastic 307, 308
 Turpentine 222

U

U-Channel Sign Post ???
 U-Lamp Fluorescent Lamps 238
 Under Cabinet Fluorescent Fixture ... 240
 Union Brass Stems 286, 287
 Urinal Blocks 207

Utility
 Blades 62, 63
 Knives 63

V

Vacuum
 Bags 200, 201
 Belts 200
 Canister 200
 Upright 200
 Wet/Dry 201
 Vacuum Cleaners 200, 201

Valve
 Ball 305
 Drain, Water Heater 281
 Flush 292, 293
 Four-Way Key 301
 Gas 226
 Gate 305
 Icemaker 272, 305
 Relief 281
 Saddle 272
 Shower 280
 Stop 271
 Stop & Waste 305
 Stop Check, Sump Pump 301
 Tub and Shower 280
 Vandal Spray 211
 Vanities, Bathroom 277
 Vanity Tops 277
 Varnish 222
 Vegetation Kill 187

Vent
 Hood 225
 Lint Trap, Dryer 226
 Vertical Blinds 230
 Vest, Safety 38
 Viewers, Door 143
 Vinyl Floor Tile 166

Vinyl Mini-Blinds 230
 Vise Grip 88
 Voltage Tester 258

W

Wall
 Adhesive 154
 Bends 273
 Bumpers 142
 Door Stops 142, 143
 Jacks 253
 Patch 154
 Plates 253, 256
 Protection 142
 Sander 71
 Switches 255
 Tile 164
 Tile Grout 155
 Wand, Striping 220
 Warehouse Broom 191

Washer
 Shank, Ballcock 294
 Shank, Flush Valve 294

Washers
 Faucet 290
 Fender 171
 Flat 171
 Hose 186
 Lock 171
 Machine Screw 171
 Overflow 262
 Sink Connection 275
 Slip Joint
 Cone 275
 Polyethylene 275
 Rubber 275
 Spud 291
 Washing Machine Hose 270
 Wasp and Hornet Spray 188
 Waste Arms 274
 Wastebaskets 197

Water
 Coolers 40
 Diverters 158
 Supply Lines 271
 Water Heater, Relief Valve 281
 Water Heater, Removal Tool 302
 Wax Rings 291
 WD-40 Lubricant 212

Weather Strip
 Magnetic 159
 Foam 159
 Jamb 159
 Weather Stripping 159
 Weatherproof Outlets 249
 Weed Killer 187

Wet Floor Sign 197
 Wet/Dry Vacuum Cleaners 201
 Wheelbarrow 184

Wheels
 Cut-Off 23
 Grinding 23
 Whirlaway Garbage Disposals 269
 Whisk Broom 191
 Windex 208

Window
 Balances 102
 Cleaner 208
 Glazing 155
 Locks 103
 Roller Assemblies 103
 Sash Locks 103
 Scraper 71, 72
 Screen
 Frame 106
 Hardware 103
 Spline 106
 Wipes 199
 Window and Tile Cleaner 208
 Windshield Washer 214

Wire
 Brush 218
 Cable 250
 Connectors 250
 Nuts 250
 Solder 303
 Staples 248
 Stripper 67
 Wiring Devices 255

Wood
 Chisel 75, 83
 Doors 167
 Filler 154
 Putty 154
 Rules 79
 Scrapers 71
 Wrap Around Fixture 240
 Wrecking Bar 84

Wrench
 Adjustable 88
 All-Purpose 302
 Angle Seat 302
 Basin 301
 Four Way 301
 Hex and Square End 88
 Lock Nut 302
 Pipe 90
 Socket 302
 Spud 302
 Strainer 301, 302
 Wringer, Mop 196

X / Y / Z

X-14 Mildew Remover 206
 Zud Cleanser 206



Mill Supply Company Inc.

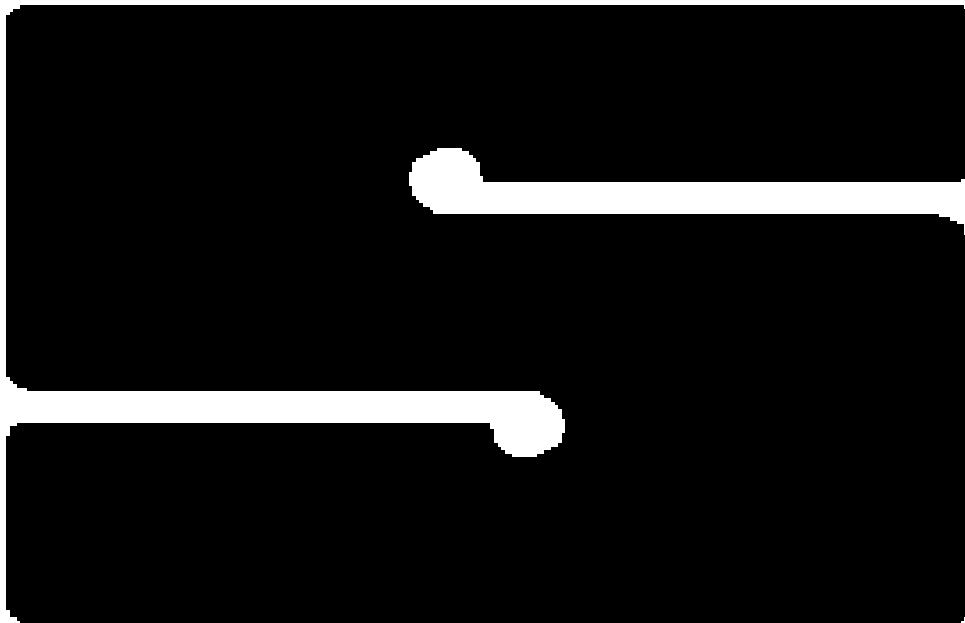

6210 Frankford Ave. Baltimore, Maryland. 21206

Phone (410) 485-3343 Toll Free 800-817-8183

Fax (410) 325-2240

Hours of Operation M-F 7:30am - 5:00pm